

Tor Helge Dokka, Aoife Houlihan Wiberg, Laurent Georges,
Sofie Mellegård, Berit Time, Matthias Haase, Mette Maltha and
Anne G. Lien

A zero emission concept analysis of a single family house

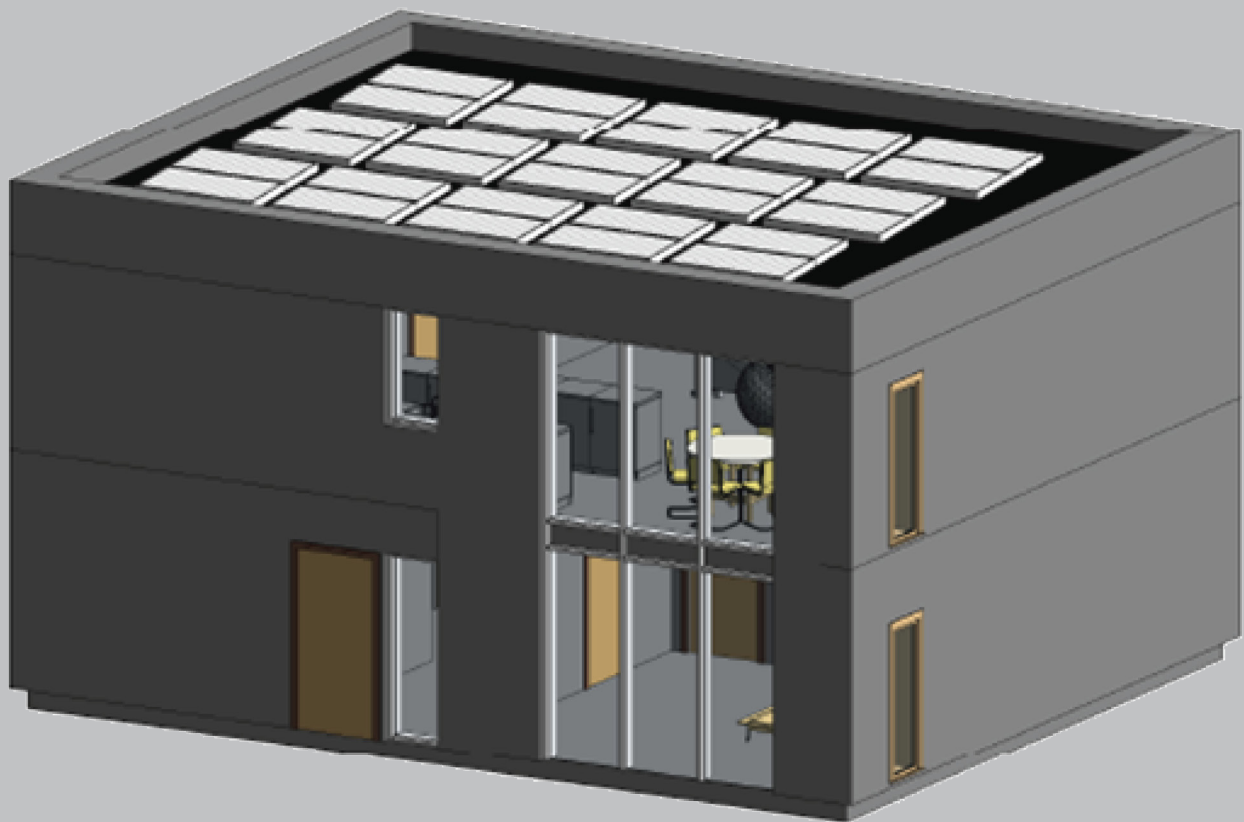

SINTEF Academic Press

Tor Helge Dokka¹⁾, Aoife Houlihan Wiberg²⁾, Laurent Georges²⁾, Sofie Mellegård¹⁾, Berit Time¹⁾,
Matthias Haase¹⁾²⁾, Mette Maltha¹⁾ and Anne G. Lien¹⁾

A zero emission concept analysis of a single family house



ZEB Project report 9 – 2013

ZEB Project report no 9

Tor Helge Dokka¹⁾, Aoife Houlihan Wiberg²⁾, Laurent Georges²⁾, Sofie Mellegård¹⁾, Berit Time¹⁾,
Matthias Haase¹⁾²⁾, Mette Maltha¹⁾ and Anne G. Lien¹⁾

A zero emission concept analysis of a single family house

Keywords:

Zero emission building, residential concept building, delivered energy, embodied energy, green house gas emissions, PV

ISSN 1893-157X (online)

ISSN 1893-1561

ISBN 978-82-536-1324-6 (pdf)

ISBN 978-82-536-1326-0 (printed)

28 copies printed by AIT AS e-dit

Content: 100 g Scandia

Cover: 240 g Trucard

© **Copyright SINTEF Academic Press and Norwegian University of Science and Technology 2013**

The material in this publication is covered by the provisions of the Norwegian Copyright Act. Without any special agreement with SINTEF Academic Press and Norwegian University of Science and Technology, any copying and making available of the material is only allowed to the extent that this is permitted by law or allowed through an agreement with Kopinor, the Reproduction Rights Organisation for Norway. Any use contrary to legislation or an agreement may lead to a liability for damages and confiscation, and may be punished by fines or imprisonment.

Norwegian University of Science and Technology ²⁾

N-7491 Trondheim

Tel: +47 22 73 59 50 00

www.ntnu.no

www.zeb.no

SINTEF Building and Infrastructure Trondheim ¹⁾

Høgskoleringen 7 b, POBox 4760 Sluppen, N-7465 Trondheim

Tel: +47 22 73 59 30 00

www.sintef.no/byggforsk

www.zeb.no

SINTEF Academic Press

c/o SINTEF Building and Infrastructure Oslo

Forskningsveien 3 B, POBox 124 Blindern, N-0314 Oslo

Tel: +47 22 96 55 55, Fax: +47 22 69 94 38 and 22 96 55 08

www.sintef.no/byggforsk

www.sintefbok.no

Acknowledgement

This report has been written within the *Research Centre on Zero Emission Buildings (ZEB)*. The authors gratefully acknowledge the support from the Research Council of Norway, BNL – Federation of construction industries, Brødrene Dahl, ByBo, DiBK – Norwegian Building Authority, DuPont, Enova SF, Entra, Forsvarsbygg, Glava, Husbanken, Hydro Aluminium, Isola, Multiconsult, NorDan, Norsk Teknologi, Protan, Skanska, Snøhetta, Statsbygg, VELUX, Weber and YIT.

Abstract

The main aim of the work has been to do modeling and calculations of the energy use, embodied emission and the total CO₂-emission for a typical Norwegian residential building. By doing this we try to reveal and study the main drivers for the CO₂-emission, and also which performance is necessary for components and solutions in a Zero Emission Building according to the current Norwegian ZEB-definition.

The preliminary conclusions from this study are:

1. For a typical single family home (2 storeys) it is rather easy to achieve a ZEB-O (Operation) level, which in this case can be labeled a zero energy building (energy produced on-site with PV equals total electricity demand).
2. Taking into account also the embodied emissions from materials and installations it is difficult to achieve the ZEB-OM (Operation and Material) level by using only the flat roof for PV-production.
3. Even if the calculation of embodied emission (EE) has considerable uncertainties, preliminary results indicate that EE is significantly higher than the emission related to operational energy use. However, in current calculation no significant effort has been made to reduce EE, in contrast to operational energy use where high performance solutions have been used.
4. To achieve a ZEB-OM level a combination of further reduced energy demand, high COP/SPF thermal systems, reduced embodied emissions and increased PV-production seems to be the solution.

Contents

| | |
|--|-----------|
| 1. INTRODUCTION | 7 |
| 1.1 BACKGROUND | 7 |
| 1.2 AIM AND SCOPE OF THE WORK | 7 |
| 1.3 ABOUT THE REPORT | 7 |
| 1.4 SIMULATION TOOLS AND METHODS USED | 8 |
| 1.5 ZEB-DEFINITION AND DIFFERENT ZEB- LEVELS | 9 |
| 2. BUILDING MODEL | 11 |
| 3. BUILDING ENVELOPE | 15 |
| 3.1 THERMAL SPECIFICATION OF THE BUILDING ENVELOPE | 15 |
| 3.2 EXTERNAL WALL | 15 |
| 3.3 EXTERNAL ROOF | 16 |
| 3.4 FLOOR CONSTRUCTION | 17 |
| 3.5 WINDOWS | 18 |
| 3.6 THERMAL BRIDGES | 19 |
| 3.7 HEAT LOSS BUDGET | 19 |
| 4. BUILDING SERVICES | 20 |
| 4.1 VENTILATION SYSTEM | 20 |
| 4.2 HEATING SYSTEM | 21 |
| 4.2.1 Pumps | 23 |
| 4.3 LIGHTING AND APPLIANCES | 23 |
| 4.3.1 Lighting system | 23 |
| 4.3.2 Appliances | 24 |
| 4.3.3 Domestic hot water (DHW) | 24 |
| 5. ENERGY SUPPLY SYSTEM | 26 |
| 5.1 SOLAR COLLECTOR SYSTEM | 26 |
| 5.2 HEAT PUMP SYSTEM | 27 |
| 5.3 PV-SYSTEM | 27 |
| 6. EMBODIED ENERGY AND GREEN HOUSE GAS EMISSIONS | 29 |
| 6.1 METHOD | 29 |
| 6.1.1 Goal and scope | 29 |
| 6.2 LIFE CYCLE INVENTORY - USING BIM | 30 |
| 6.3 LIFE CYCLE INVENTORY – ENVIRONMENTAL DATA, TECHNICAL INSTALLATIONS AND SIMPLIFICATIONS | 36 |
| 6.3.1 Technical installations | 36 |
| 6.3.2 Simplifications and uncertainty | 37 |
| 6.4 RESULTS | 38 |
| 6.4.1 Carbon dioxide emissions | 38 |
| 6.5 SUMMARY | 42 |
| 7. ENERGY AND CO₂ CALCULATIONS | 44 |
| 7.1 NET ENERGY BUDGET | 44 |
| 7.2 EL-SPECIFIC AND THERMAL DEMAND | 45 |
| 7.3 THERMAL ENERGY SUPPLY SYSTEM | 47 |
| 7.4 GROSS DELIVERED ENERGY AND RELATED CO ₂ EMISSIONS | 49 |
| 7.5 EMBODIED AND TOTAL CO ₂ EMISSIONS | 50 |
| 7.6 DESIGN OF ON-SITE ELECTRICITY PRODUCTION AND TOTAL CO ₂ BALANCE | 51 |
| 7.7 MISMATCH IN DEMAND AND PRODUCTION | 51 |
| 8. INDOOR CLIMATE SIMULATIONS | 53 |
| 8.1 THERMAL COMFORT SUMMER | 53 |
| 8.1.1 First floor | 54 |
| 8.1.2 Second floor | 55 |

| | | |
|------------|---|-----------|
| 8.2 | AIR QUALITY | 56 |
| 8.2.1 | First and second floor..... | 56 |
| 8.2.2 | Large bedroom..... | 57 |
| 9. | DISCUSSION, PRELIMINARY CONCLUSIONS AND FURTHER WORK | 58 |
| 9.1 | DISCUSSION | 58 |
| 9.2 | PRELIMINARY CONCLUSION..... | 59 |
| 9.3 | FURTHER WORK..... | 59 |
| 10. | REFERENCES..... | 61 |
| | APPENDICES | |

1. Introduction

1.1 Background

This concept work started in late autumn 2011, with an analysis of two very simplified shoebox models; one for an office building and one for a residential building. In the beginning of 2012, it was decided to design more realistic building models, and a typical two storey single family house was chosen for the residential concept work. The single family house has been designed as a 3D-BIM model, modeled in the CAD tool Revit \1\.

1.2 Aim and scope of the work

The main aim of this work is to do realistic simulations and calculations of the energy use, embodied emission and the total CO₂-emission for a typical residential building. By doing this we will try to reveal the main drivers for the CO₂-emission, and also what performance is necessary for components and solutions in a Zero Emission Building according to the current ZEB-definition, see paragraph 1.5.

1.3 About the report

Chapter 2 of this report describes the building model used in this concept analysis. Chapter 3-5 describes the technical solutions used for the building envelope, the building services and the energy supply. Chapter 6 outlines the embodied emission and embodied energy calculations, and chapter 7 treats the energy and overall CO₂-calculations. Chapter 8 deals with thermal comfort, IAQ and daylight simulations to verify that the indoor climate is satisfactory. Chapter 9 discusses the results, and gives preliminary conclusions and plans for further work.

The Oslo climate has been used in all calculations and/or simulations. In a Norwegian context, the Oslo climate can be seen as representative for a large part of the Norwegian building stock. However, a significant part of the existing and future Norwegian building stock are situated in climates much colder than Oslo, giving raise to a much higher heating demand than in Oslo climate. In addition, and often more important, more northern and/or cloudier climates, compared to Oslo, will also have a large drawback in using solar energy for solar thermal collectors and PV¹.

In some cases, two or three alternatives are evaluated but no sensitivity analyses have been done. This will be further elaborated in the continuing concept work.

¹ PV: Photovoltaics which turn solar radiation into electricity.

ZEB-Design

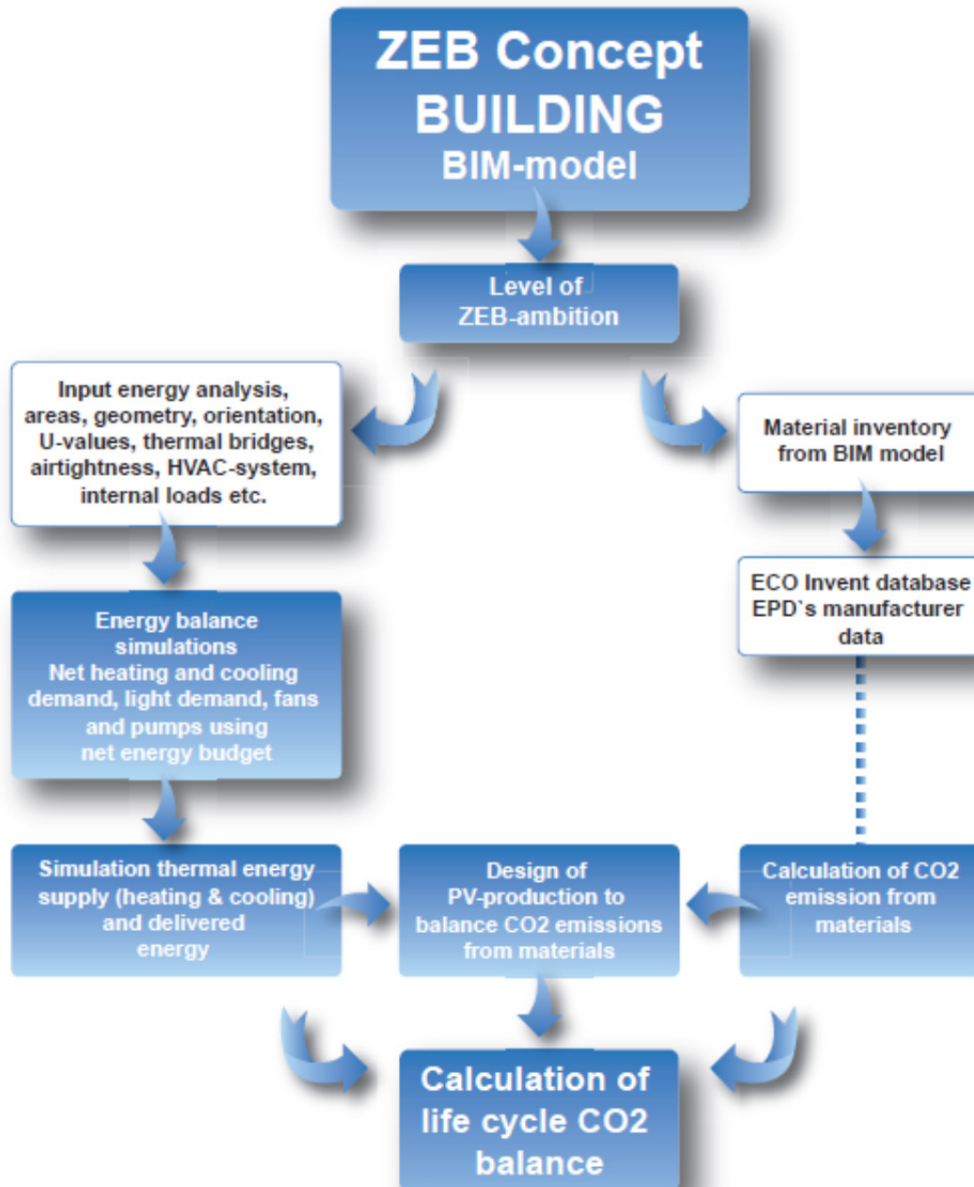

Figure 1.1 The work flow used during the ZEB concept work.

1.4 Simulation tools and methods used

The 3D architectural drawings and 3D BIM modeling have been done in Revit version 2012 \1\.
The embodied emissions and energy calculations have been done in the tool LCA Software tool, SimaPro version 7.3 \2\ which use data from the LCA database EcoInvent \3\.
The material inventories have been imported from the Revit BIM-model, via Excel.

Simulation of annual heating and cooling demand, peak heating and cooling load, net energy budget, delivered energy and heat loss calculations have been done in SIMIEN version 5.011 \4\.
The

performance of solar collector system and the heat pump system have been simulated using PolySun \5\. The performance of the PV-systems have been simulated with PV-syst \6\.

1.5 ZEB-definition and different ZEB- levels

Currently a revised definition of ZEB is in making, which will be finished in the spring 2013 \15\. The current definition is based on nine criteria:

1. Ambition level
2. Basis for calculation
3. System boundaries
4. CO₂-factors
5. Energy quality
6. Mismatch production and demand
7. Minimum requirements energy efficiency
8. Requirements indoor climate
9. Verification in use

We will not go into detail about these criteria, besides saying something about the minimum requirements on energy efficiency and ambition levels currently defined. The minimum requirements on energy efficiency are proposed to be in accordance with those stated in NS3700 \1\. How these requirements are met is commented throughout the report.

Figure 1.2 illustrates how the different ambition levels take into account different emission items. The four levels are at the moment defined as:

1. ZEB-O÷EQ: Emission related to all energy use except the energy use for equipment (appliances) shall be zero. Energy use for equipment is often regarded as the most user dependent, and difficult to design for low energy use.
2. ZEB-O: Emission related to all operational energy use shall be zero, also energy use for equipment.
3. ZEB-OM: Emission related to all operational energy use plus all embodied emission from materials and installations shall be zero. ***This is the level were aiming to achieve in this study.***
4. ZEB-COM: Same as ZEB-OM, but also taking into account emissions related to the construction process of the building. At the moment we don't have the data and methods to quantify these emissions in an accurate way.

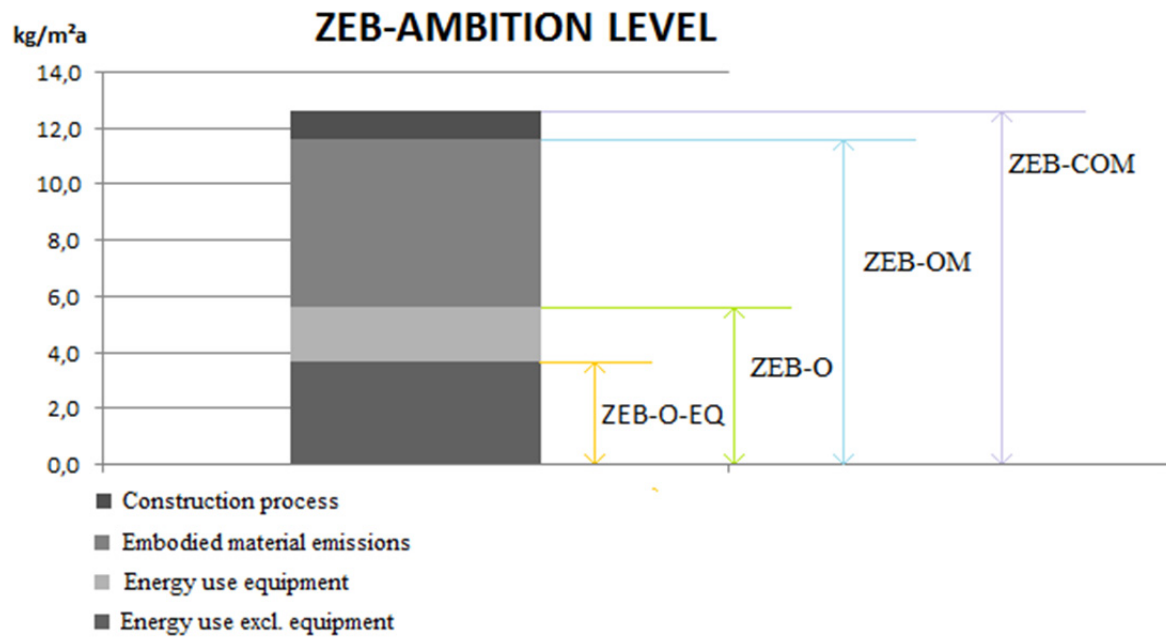

Figure 1.2 Different ZEB ambition levels in the current ZEB-definition.

2. Building Model

The concept building is a 2 storey high single family home (SFH) with slab on ground. The rectangular footprint of the building is approximately 10 x 8 meters (inside dimensions), with long facades facing south and north. The SFH contains four bedrooms and two bathrooms.

Each floor has a heated floor area (BRA) of 80 m², giving a total area of 160 m² BRA. The total windows and door area are 36 m², which gives a windows/door to floor area ratio of 22.5 %. This is a normal ratio, and the windows and door area constitute 35 % of the (vertical) façade area.

Figures 2.1 to 2.7 give perspective, facades, floor plans and sections of the building.

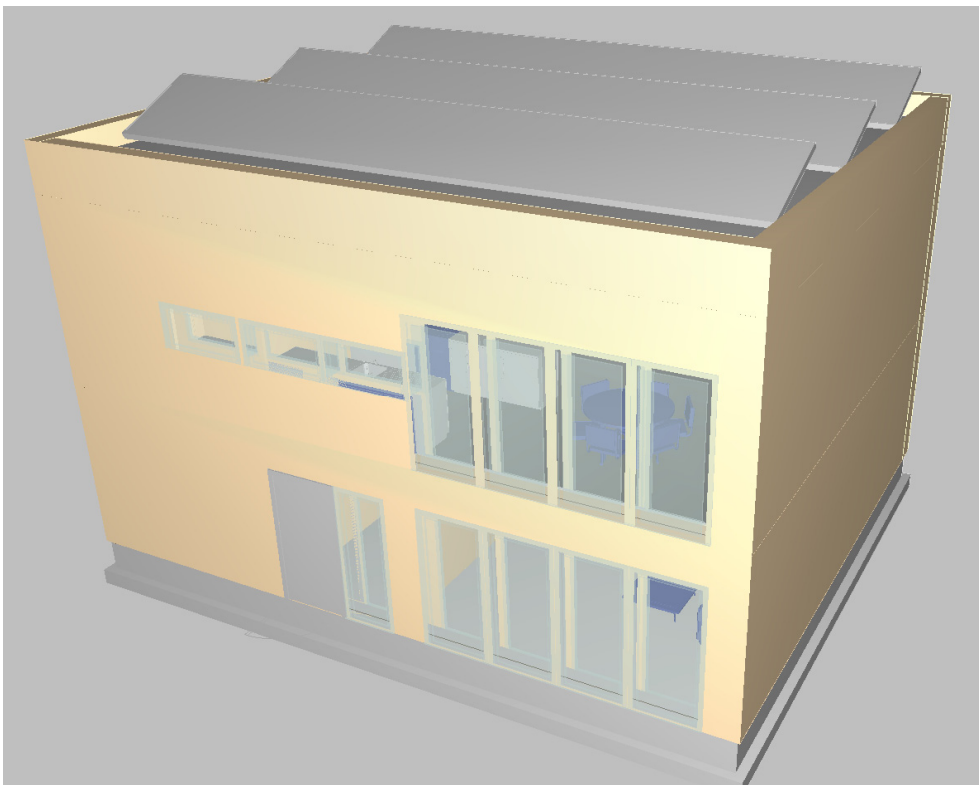

Figure 2.1 Perspective of the office building.

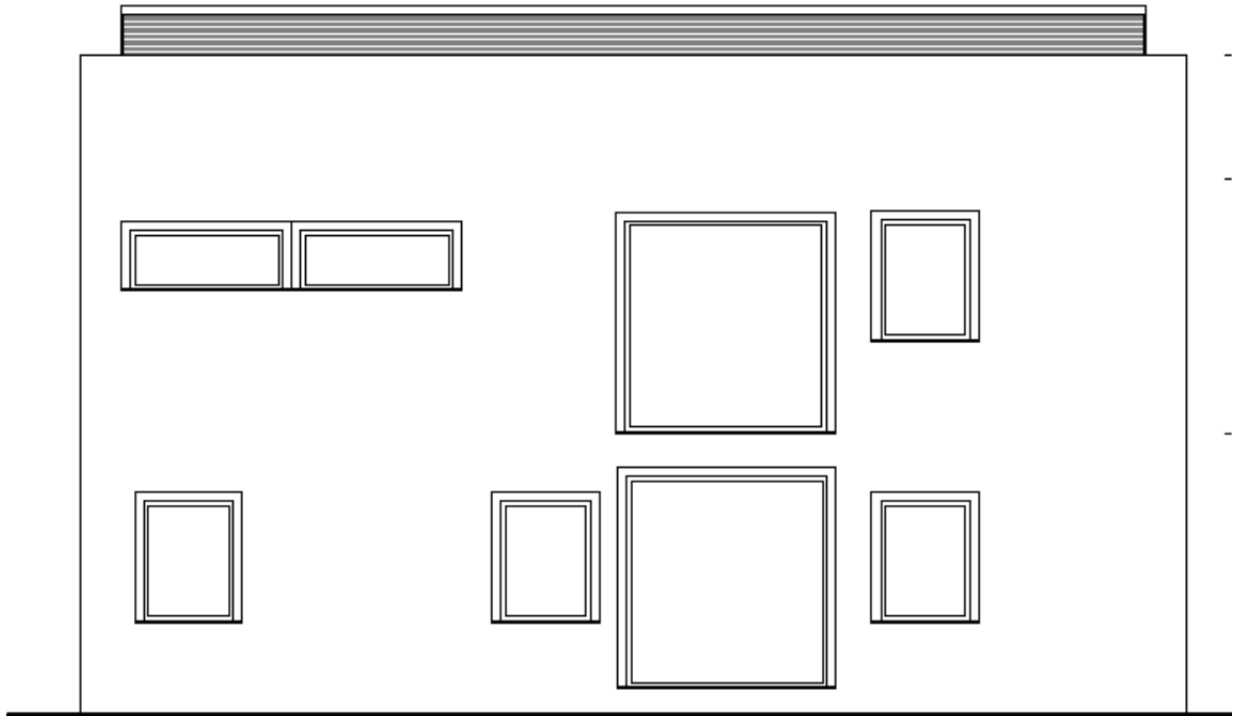

Figure 2.2 North façade.

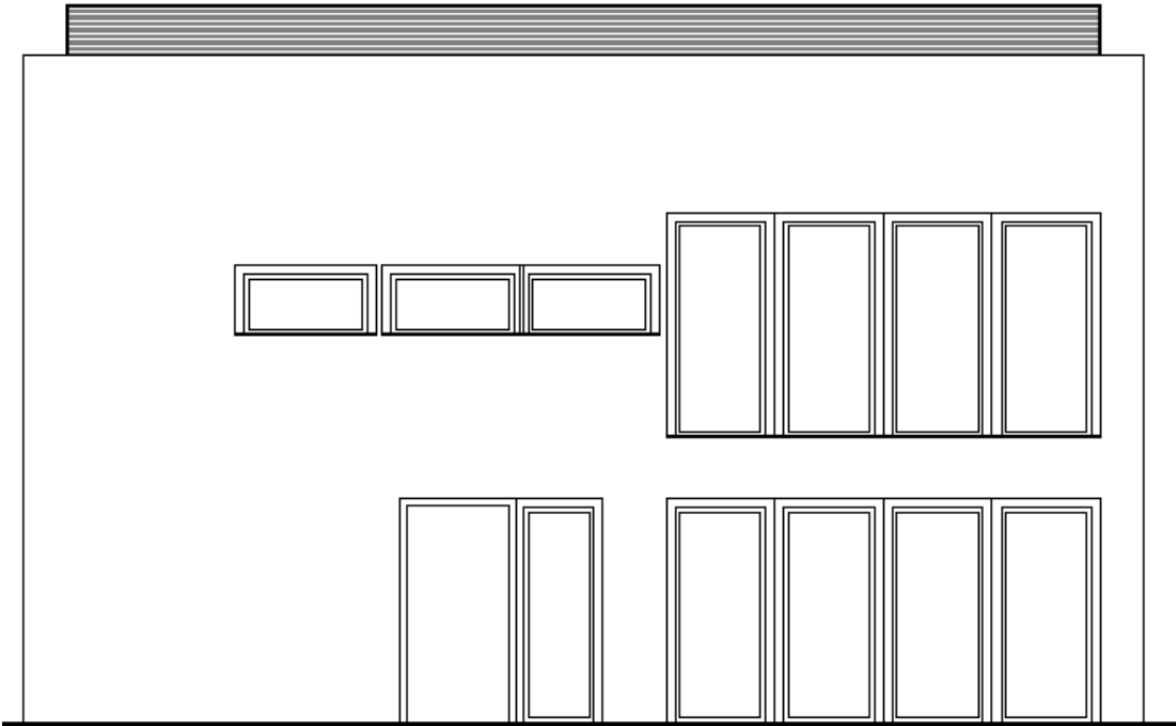

Figure 2.3 South façade

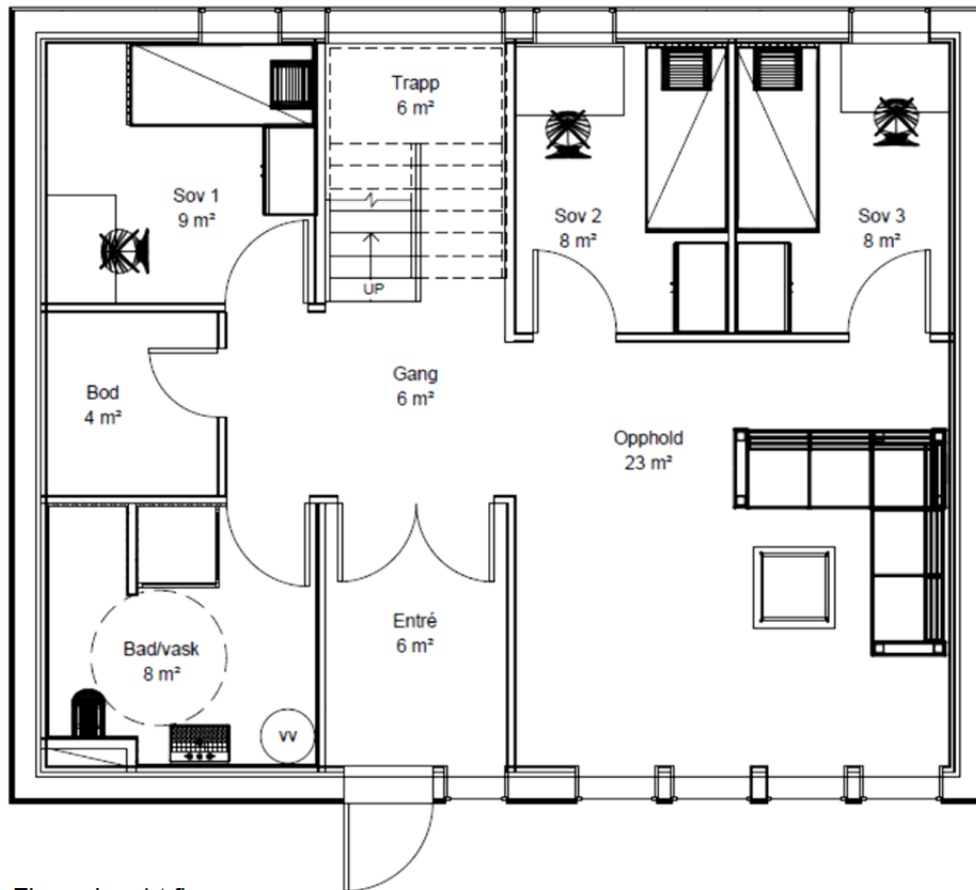

Figure 2.4 Floor plan 1st floor.

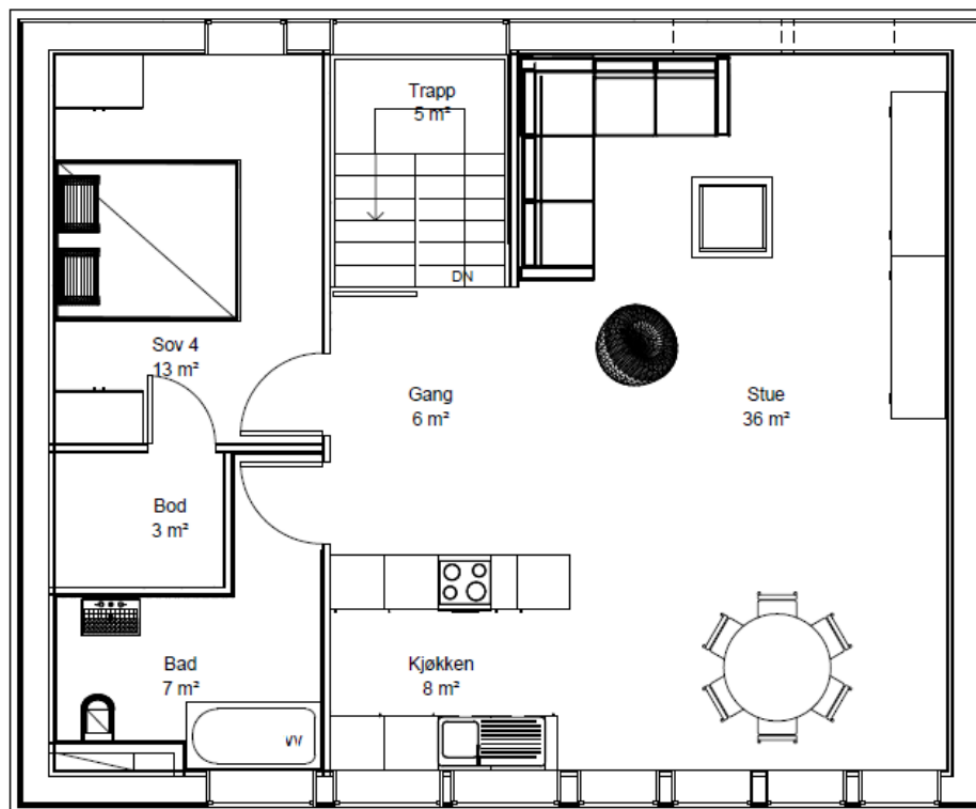

Figure 2.5 Floor plan 2nd floor.

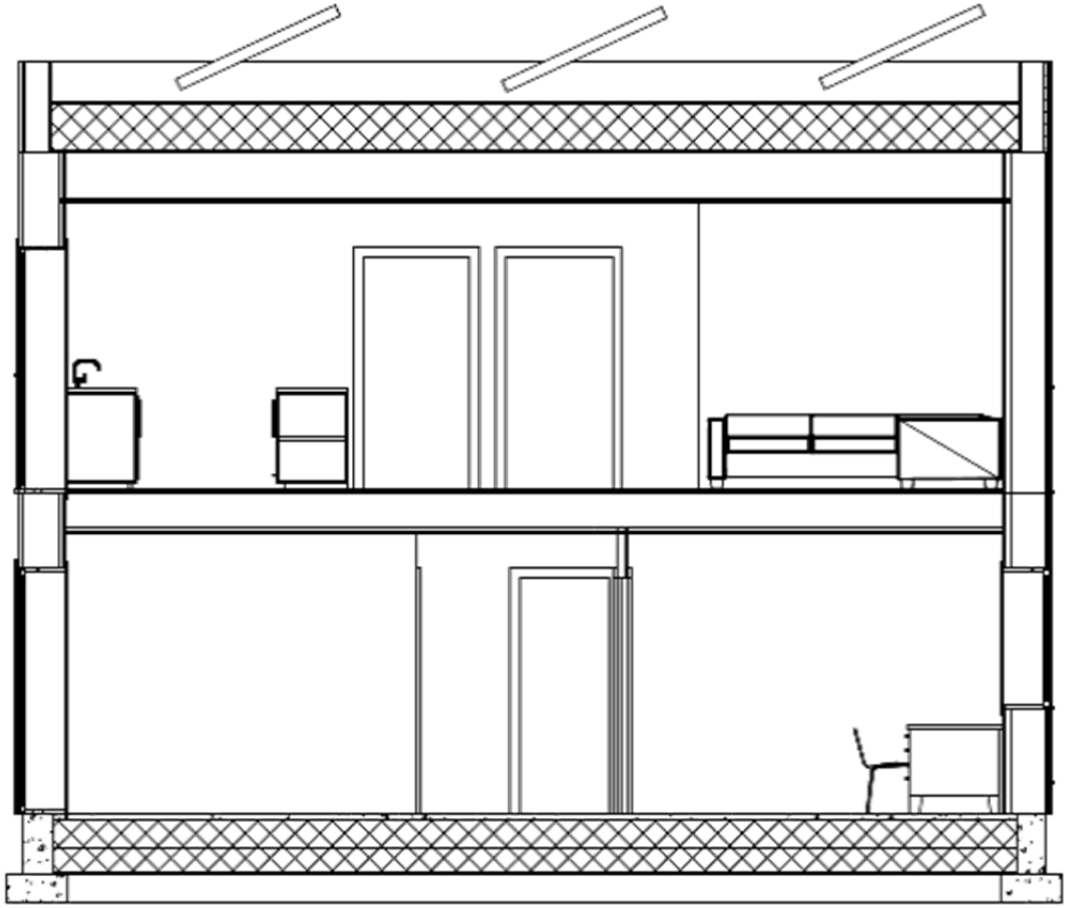

Figure 2.6 Section A-A.

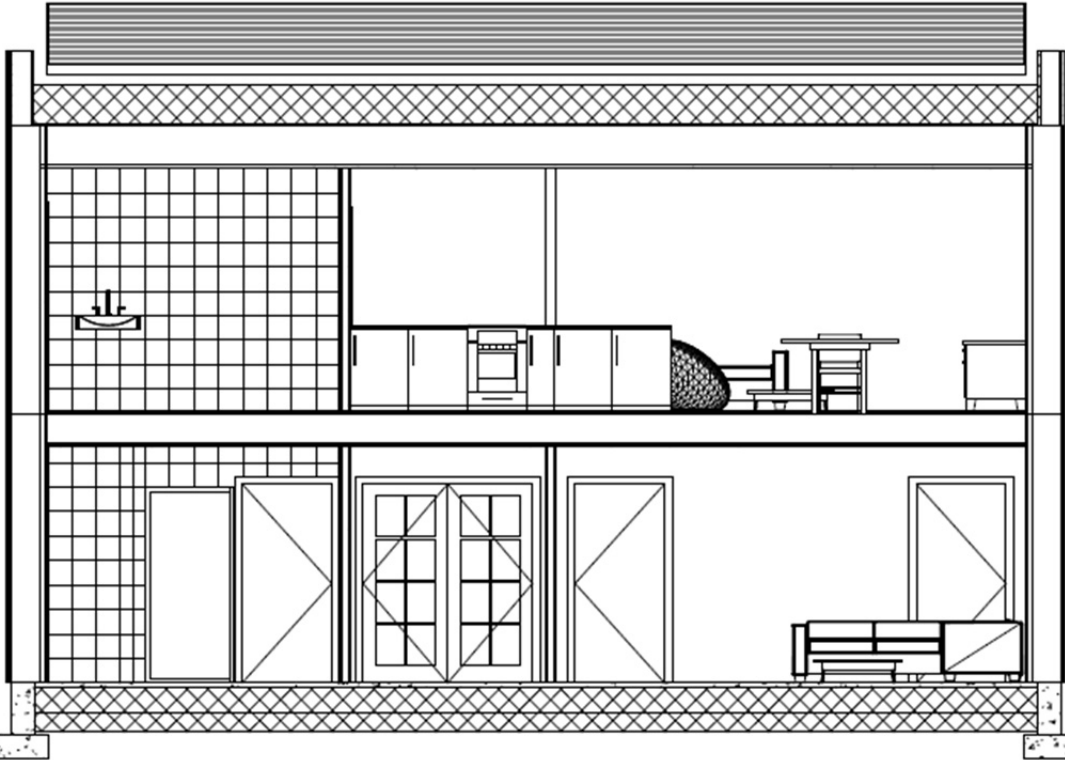

Figure 2.7 Section B-B.

3. Building Envelope

3.1 Thermal specification of the building envelope

Table 3.1 gives the thermal specification of the building envelope. Even though this is a high performance building envelope, these figures can be achieved by materials and solutions already on the market.

Table 3.1 Specification for the building envelope.

| | Values | Solution |
|---------------------------------|--|--|
| External walls | $U = 0.12 \text{ W/m}^2\text{K}$ | Timbered wall with 350 mm insulation. |
| External roof | $U = 0.10 \text{ W/m}^2\text{K}$ | Compact roof with approximately 450 mm insulation. |
| Slab on ground | $U = 0.07 \text{ W/m}^2\text{K}$ ($U = 0.06 \text{ W/m}^2\text{K}$) | Floor construction with 500 mm insulation. U-value in brackets takes into account the thermal resistance of the ground. |
| Windows | $U = 0.65 \text{ W/m}^2\text{K}$ | Three layer low energy windows, with insulated frame. |
| Doors | $U = 0.65 \text{ W/m}^2\text{K}$ | Well insulated doors. |
| Normalized thermal bridge value | $\psi'' = 0.03 \text{ W/m}^2\text{K}$ | Detailed thermal bridge design |
| Air tightness | $N50 < 0.3 \text{ ach}@50 \text{ Pa}$ | Detailed design of a continuous vapour and wind barrier, good quality assurance and pressure testing of the building in two stages (when the wind barrier is mounted and when the building is finished). |

3.2 External wall

A well insulated timber frame wall constructed as shown in Figure 3.1 has been used in the design. This construction gives a U-value of $0.12 \text{ W/m}^2\text{K}$.

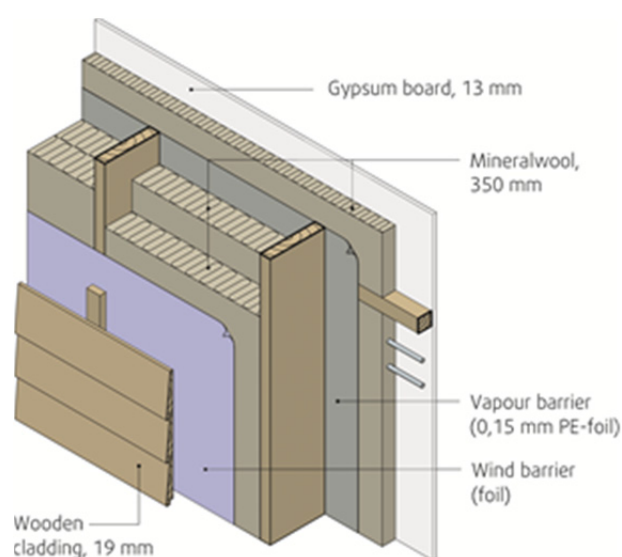

Figure 3.1 Principle section of the external wall.

Different wooden wall constructions can achieve this U-value of 0.12 W/m²K. Figure 3.2 shows the necessary insulation thickness for different wooden walls reaching a U-value of 0.12 W/m²K with an insulation material with a conductivity of 0.033 W/mK.

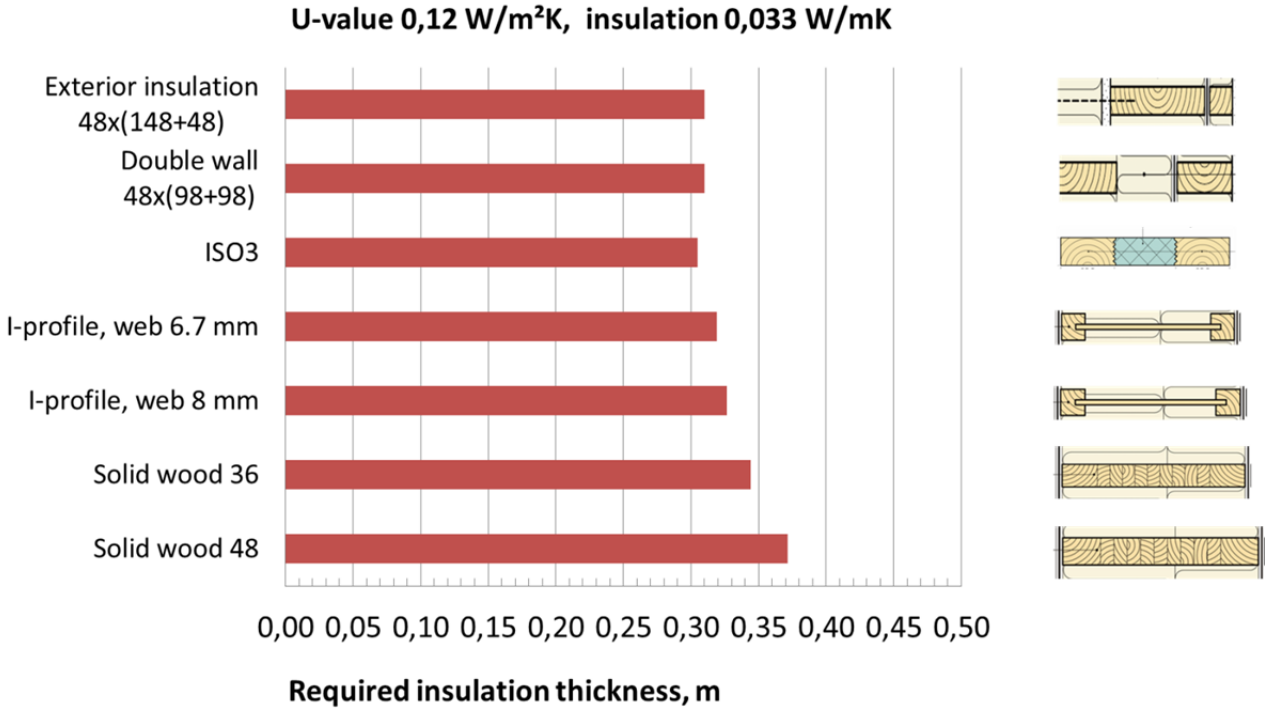

Figure 3.2 Necessary insulation thickness for different wooden walls reaching a U-value of 0.12 W/m²K with an insulation material with a thermal conductivity of 0.033 W/mK, from Uvsløkk et al., \7\.

3.3 External roof

A well insulated compact roof construction supported on wooden loadbearing trusses/beams has been used in the design. The insulation thickness is 400 mm insulation, giving a U-value of 0.10 W/m²K. The roof construction is shown in Figure 3.3.

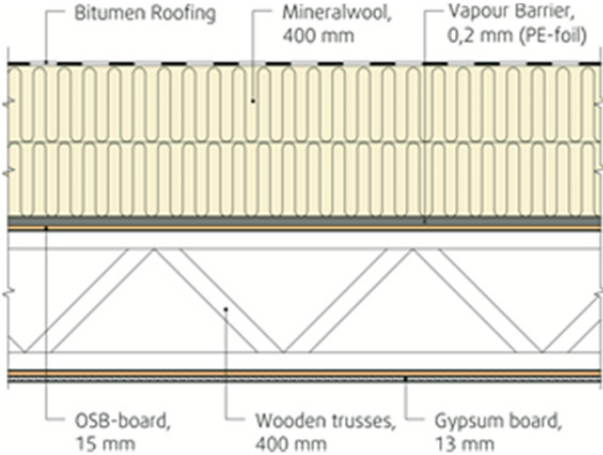

Figure 3.3 Schematic section of the external roof.

Different roof constructions can reach the U-value. Figure 3.4 shows the necessary insulation thickness for different roof constructions reaching a U-value of 0.10 W/m²K.

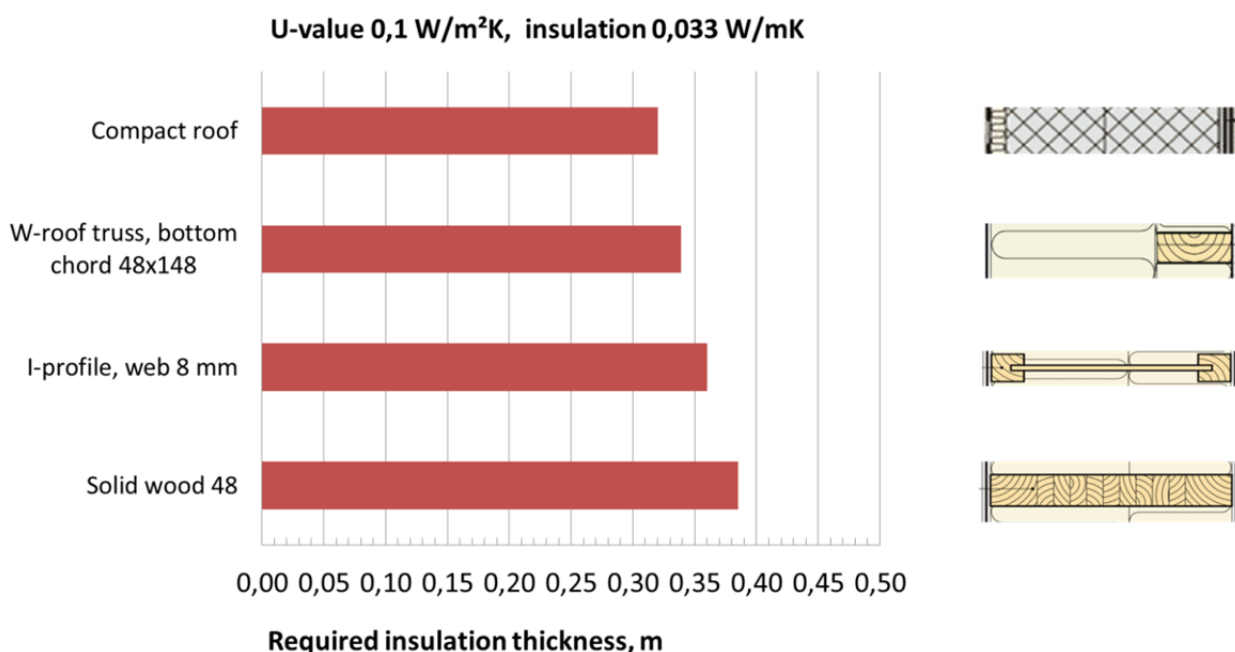

Figure 3.4 Necessary insulation thickness for different roof constructions reaching a U-value of 0.10 W/m²K with an insulation material with a conductivity of 0.033 W/mK. From Uvsløkk et al. [7].

3.4 Floor construction

The floor construction consists of 500 mm insulation with a 100 mm concrete slab on top. This gives a U-value for the floor construction of 0.07 W/m²K. Included the thermal resistance in the ground, the total U-value² become 0.06 W/m²K.

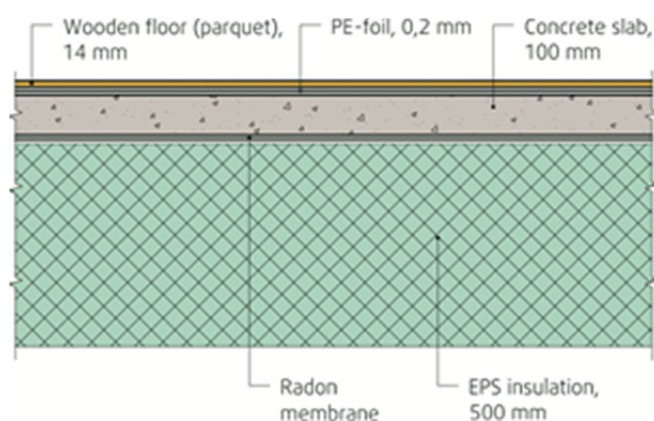

Figure 3.5 Schematic section of the slab on ground construction.

² The equivalent stationary U-value for the floor calculated according to NS-ISO 13370.

3.5 Windows

Three-pane windows with insulated frame and sash are used. The mean U-value of the windows is 0.65 W/m²K. The g-value of the windows is 0.40. The windows are positioned in the middle of the wall in order to reduce the thermal bridge effect, see Figure 3.6.

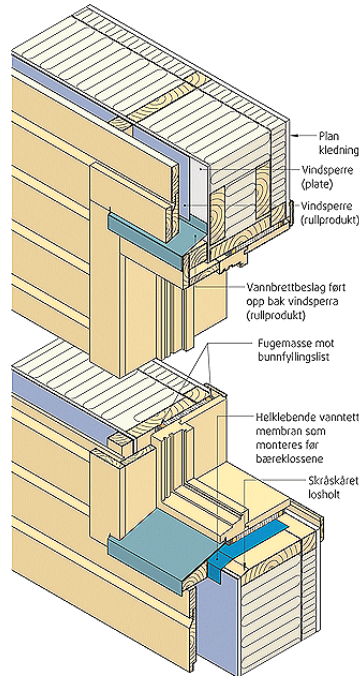

Figure 3.6 Sketch showing an optimal position of a window regarding thermal performance. It is positioned towards the middle of the wall in order to reduce the thermal bridge effect.

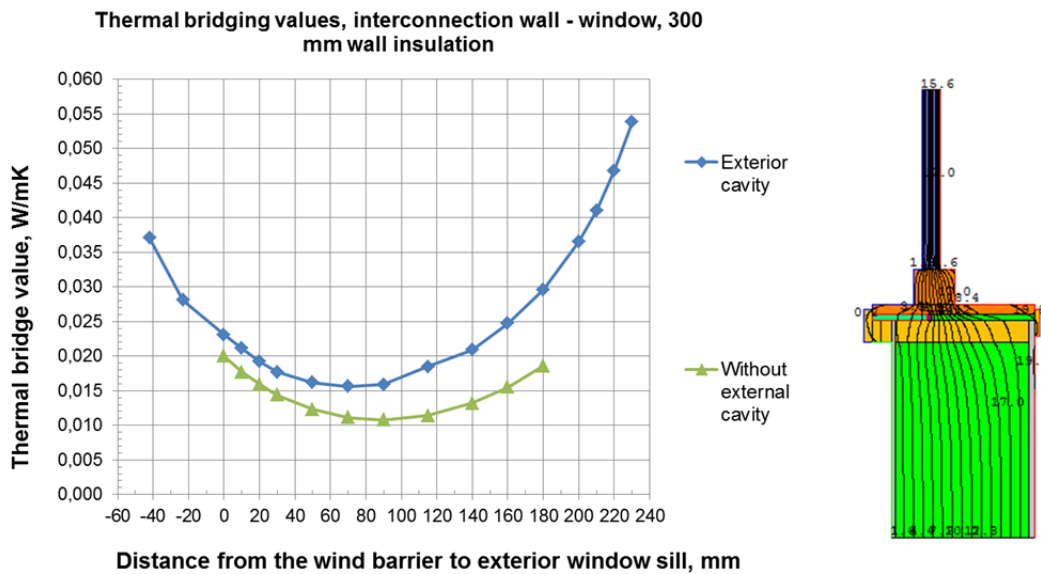

Figure 3.7 The graph shows calculated thermal bridge values (y-axis), depending on the position of the window, given as the distance between the outer window frame and the exterior sheathing, from Uvsløkk et al. [7].

3.6 Thermal bridges

The heat loss due to thermal bridges is in accordance with the requirements in the Norwegian passive house standard NS 3700 \9\ (0.03 W/m²K) as the normalized thermal bridge value according to NS 3031 \10\. Best practice principles in detailing have to be applied. The insulation should primarily be on the outside of the loadbearing structure to reduce thermal bridges to a minimum. The windows should be positioned to the middle of the wall. Table 3.2 gives a rough estimate of the thermal bridge losses for the building. Thermal bridge values are primarily taken from Gustavsen et al. \11\. All details for the junctions have not been detailed in this phase of the concept work, and the thermal bridge heat loss budget is therefore only indicative. Based on the estimated heat loss in Table 3.2, the normalized thermal bridge value become:

$$\psi'' = 5.52/160 = 0.03 \text{ W/m}^2\text{K}.$$

Table 3.2 Thermal bridge heat loss for the building.

| Thermal bridge | Thermal bridge value | Length | Heat loss |
|----------------------------------|----------------------|--------|-----------|
| Wall-floor junction ¹ | 0.04 W/mK | 36 m | 1.44 |
| Wall-roof junctions ³ | 0.04 W/mK | 36 m | 1.44 |
| Partition floor – wall junction | 0.01 W/mK | 36 m | 0.36 |
| Window perimeter ⁴ | 0.015 W/mK | 99.7 m | 1.50 |
| Door perimeter ⁵ | 0.02 W/mK | 6.2 m | 0.12 |
| Corners ⁶ | 0.03 W/mK | 21 m | 0.66 |
| SUM | - | - | 5.52 |

3.7 Heat loss budget

The passive house standard for residential building NS3700 \9\ sets a minimum requirement for the total heat loss number³ to 0.55 W/m²K. This is also proposed as one of the minimum requirements for energy efficiency for ZEB-buildings, see paragraph 1.5. As shown in Table 3.3 the heat loss number for the ZEB-building is well below this requirement.

Table 3.3 Calculation of the heat loss number according to NS 3031 \10\.

| Item | Heat loss number |
|--|-------------------------|
| Heat loss external walls | 0.11 W/m ² K |
| Heat loss roof | 0.05 W/m ² K |
| Heat loss floor (towards cellar) | 0.03 W/m ² K |
| Heat loss windows and doors | 0.15 W/m ² K |
| Heat loss thermal bridges | 0.03 W/m ² K |
| Heat loss infiltration | 0.02 W/m ² K |
| Heat loss ventilation | 0.06 W/m ² K |
| Total heat loss number transmission and infiltration | 0.44 W/m ² K |

³ The heat loss number is the specific heat loss (W/K) divided by the heated floor are for the building, as defined in NS3031 \10\.

4. Building Services

The goal is to design a simple HVAC system (few components) with high energy performance, but without going on expense of the indoor climate. Table 4.1 gives the specification of the heating and ventilation system.

Table 4.1 Specification for the HVAC installation.

| | Values | Technical solution |
|----------------------------|---|---|
| Heat recovery | $\eta = 85 \%$ | Rotary wheel heat exchanger. |
| Specific fan power | $SFP = 1.0 \text{ kW}/(\text{m}^3/\text{s})$ | Low pressure air handling unit (AHU) and low pressure ducting system. |
| Installed cooling capacity | $Q''_{\text{cool}} = 0 \text{ W}/\text{m}^2$ | No cooling |
| Installed heating capacity | $Q''_{\text{heat}} = 18 \text{ W}/\text{m}^2$ | Installed capacity for hydronic floor heating and radiators. |

4.1 Ventilation system

The air handling unit (AHU) is placed in storage room (bod) on the first floor, see Figure 4.1. A combined air intake and exhaust grill is placed on the north façade. The AHU is equipped with a high efficiency rotary wheel exchanger with a temperature efficiency of 85 %. With such a high temperature efficiency the conventional electric heating coil often used can be skipped. Together with a rather short and low pressure ducting system, see Figures 4.1 and 4.2, this gives the low fan power of 1.0 kW/(m³/s). Data used in the simulation are based on the model UNI3 from Flexit⁴, but other manufacturers have products with comparable performance. All horizontal ducting is made in the loadbearing beams (see Figure 3.3) used for both the partition floor and the roof construction.

The air flow rate in normal use is given in Table 4.2. Forced ventilation extract in bathrooms or kitchen is compensated with raised supply air flow rate. When the house is unoccupied a switch in the entrance sets the house in standby mode, and the airflow rate is reduced to 0.7 m³/hm² (112 m³/h). Forced and reduced standby airflow rate is conservatively assumed to balance each other on a weekly basis, so a figure of 1.2 m³/hm² is also used in the simulation.

Table 4.2 Air flow rates in different rooms during normal operation.

| Room | Supply air | Extract air | Comment |
|---|-----------------------|-----------------------|--|
| Bedroom 1 | 26 m ³ /h | 0 m ³ /h | For 1 person |
| Bedroom 2 | 26 m ³ /h | 0 m ³ /h | For 1 person |
| Bedroom 3 | 26 m ³ /h | 0 m ³ /h | For 1 person |
| Bedroom 4 | 52 m ³ /h | 0 m ³ /h | For 2 persons |
| Living room 1 st floor | 30 m ³ /h | 0 m ³ /h | Also overflow supply from bedrooms (78 m ³ /h) |
| Living room/kitchen 2 nd floor | 32 m ³ /h | 72 m ³ /h | Also overflow supply from bedroom 4 (52 m ³ /h) |
| Bathroom 1 st floor | 0 m ³ /h | 60 m ³ /h | Overflow through door opening |
| Bathroom 2 nd floor | 0 m ³ /h | 60 m ³ /h | Overflow through door opening |
| SUM | 192 m ³ /h | 192 m ³ /h | Gives: 1,2 m ³ /hm ² |

⁴ WWW.flexit.no

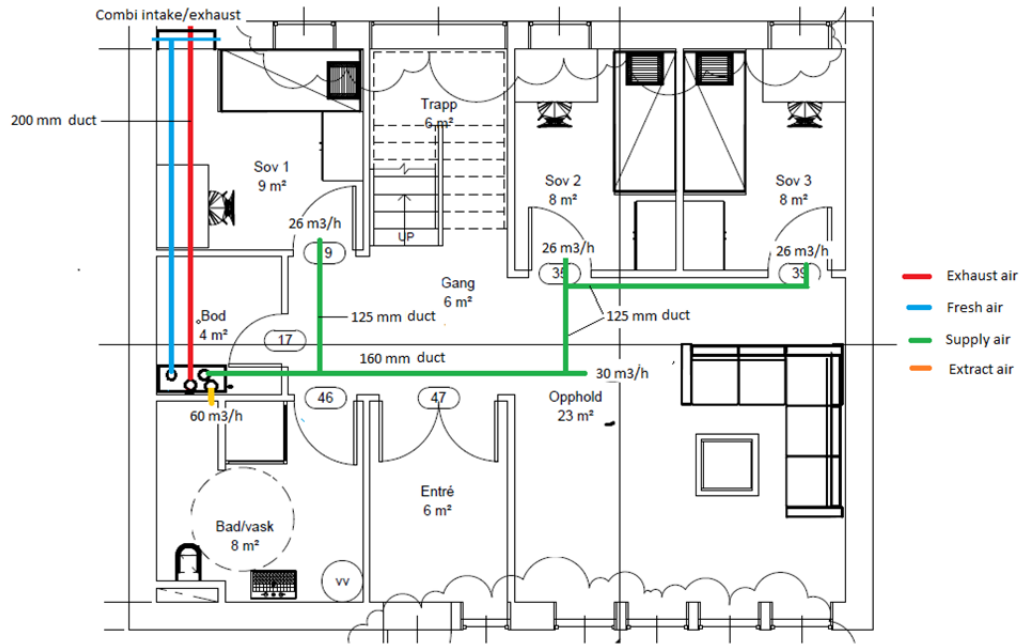

Figure 4.1 Ducting system and AHU placement 1st floor.

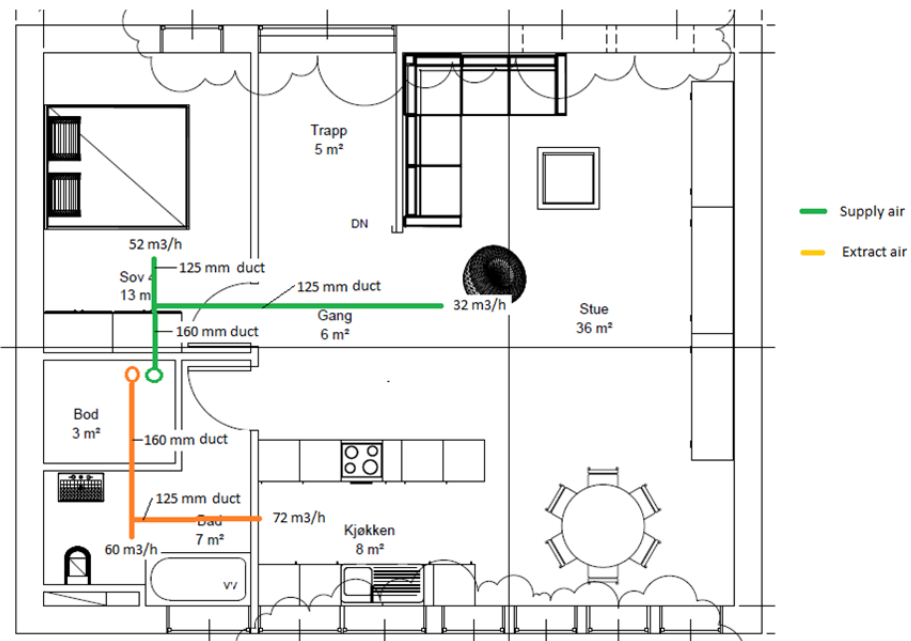

Figure 4.2 Ducting system 2nd floor.

4.2 Heating system

The heating system is a simplified hydronic system, using floor heating in bathrooms and entrance for comfort reasons. The rest of the heating demand is covered by two central radiators, one on each floor.

The central radiators, without "perimeter" heating under windows and without heating in bedrooms is possible due to a highly insulated building envelope and the triple layer super insulated windows which eliminate down draft risk.

Figures 4.3 and 4.4 illustrate the heating system for 1st and 2nd floor. The peak heating load at design winter condition is 18 W/m² (2.9 kW), which is covered by the 250 Watt floor heating in the entrance, and the radiators in 1st (1 200 Watt) and 2nd floor (1 450 Watt). The installed capacity in the bathrooms is conservatively not taken into account, because a significant part of that heat is going directly to the extract from the bathroom.

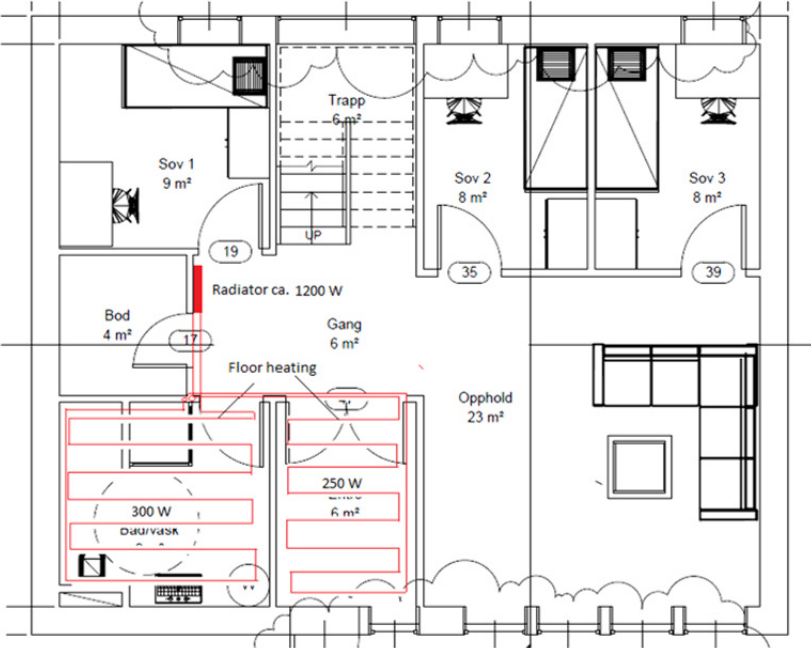

Figure 4.3 Hydronic heating system for 1st floor.

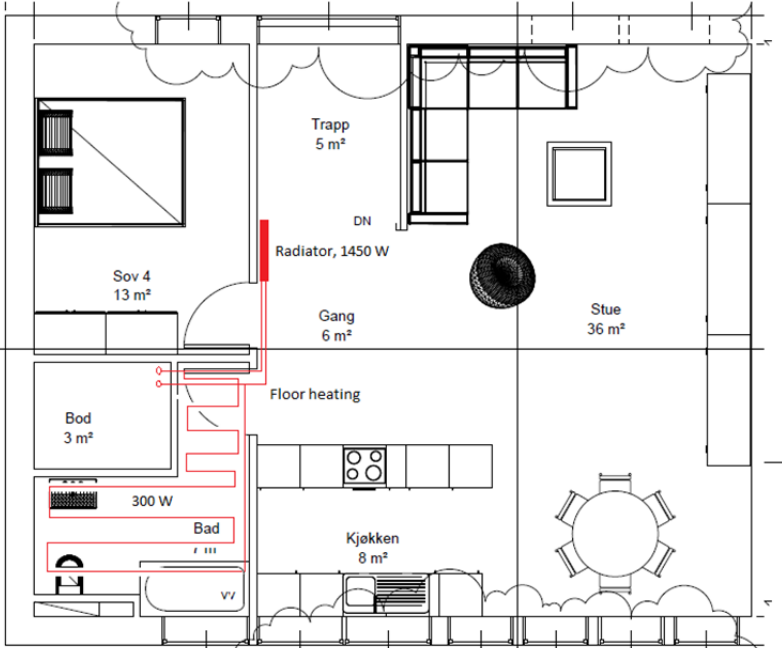

Figure 4.4 Hydronic heating system for 2nd floor.

4.2.1 Pumps

A variable flow control system for the heating system is assumed and the flow in the hydronic system is adjusted according to the heat demand. The maximum flow in the system is calculated as follows;

$$M = 1\,000 * Q / (\Delta T * C_p * \rho) = 1\,000 * 18 * 160 / (10 * 4\,180 * 988) = 0.07 \text{ l/s}$$

Q: Design heat load of 18 W/m² (2.9 kW)

ΔT : Temperature difference inlet and return in the hydronic system (45/35 °C inlet/return)

C : Heat capacity water, 4 180 J/kgK

ρ : Density water kg/m³, 988 kg/m³

According to NS3031 \10\, a default specific pump power factor for a constant volume system heating system is SPP = 0.5 kW/(l/s). With a good variable volume flow system, we have assumed a SPP value of 0.3 kW/(l/s). According to the SIMIEN simulation of the building, the operational hours of the heating system is close to 2 600 hours a normal year.

Calculating the pump energy conservatively as a constant volume system gives:

$$E = \text{SPP} * M * 2\,600 = 54 \text{ kWh/a} = 0.3 \text{ kWh/m}^2\text{a}.$$

In other words the energy used for pumps in the heating system is very small, even when conservative calculations are applied.

4.3 Lighting and appliances

4.3.1 Lighting system

The lighting system is assumed to be a very energy efficient with a combination of LED spotlights and LED lighting fixtures. The lighting system is controlled by presence control in the storage rooms. In addition, the fixed lighting is controlled by a standby switched located in the entrance, and also by a "night switch" in the main bedroom (bedroom 4).

The power demand (installed Wattage), estimated hours of operation and type of lighting in the different rooms is given in Table 4.3. The average power demand and heat load⁵ from lighting in the normalized 16 hours of operation (NS3031) is: $E_{\text{light}} = 3296/16 = 206 \text{ W}$ or $E''_{\text{light}} = 206/160 = 1.3 \text{ W/m}^2$. This is 35 % below the standardized value in NS3031 (2 W/m²), and gives an annual energy demand for lighting of 7.6 kWh/m².

⁵ It is assumed that all energy used for lighting goes over to heat in the building.

Table 4.3 Installed lighting level (Watt) and estimated hours of operation for different rooms in the SFH.

| Room | Installed Wattage | Estimated operation | Watt hours per day | Comments |
|-----------------------------------|-------------------|---------------------|--------------------|----------------------------|
| Bedroom 1 | 20 W | 10 h/day | 200 Wh | LED lighting fixtures |
| Bedroom 2 | 20 W | 10 h/day | 200 Wh | LED lighting fixtures |
| Bedroom 3 | 20 W | 10 h/day | 200 Wh | LED lighting fixtures |
| Bedroom 4 | 20 W | 10 h/day | 200 Wh | LED lighting fixtures |
| Storage, 1 st floor | 12 W | 10 h/day | 24 Wh | LED lighting fixtures |
| Storage, 2 nd floor | 12 W | 2 h/day | 24 Wh | LED lighting fixtures |
| Living room 1 st floor | 36 W | 2 h/day | 432 Wh | LED spotlight, 12 x 3 Watt |
| Bathroom 1 st floor | 18 W | 24 h/day | 432 Wh | LED spotlight, 6 x 3 Watt |
| Bathroom 2 nd floor | 18 W | 24 h/day | 432 Wh | LED spotlight, 6 x 3 Watt |
| Living room 2 nd floor | 36 W | 12 h/day | 432 Wh | LED spotlight, 12 x 3 Watt |
| Kitchen | 36 W | 12 h/day | 432 Wh | LED spotlight, 12 x 3 Watt |
| Staircase | 12 W | 24 h/day | 288 Wh | LED spotlight, 4 x 3 Watt |
| SUM | 260 W | | 3296 Wh | |

4.3.2 Appliances

Typical energy use for different energy efficient white goods and other appliances is shown in Table 4.4. The specific energy use for appliances become: $2\ 388/160 = 14.9$ kWh/m²a. This is 14 % lower than the standard value used in NS3031 \10\.

Table 4.4 Typical energy use for different energy efficient appliances.

| Appliances | Annual energy use | Comment |
|--------------------------|-------------------|---|
| Dish washer | 234 kWh | Bosch dish washer, energy label A+++. |
| Drying tumbler | 320 kWh | Siemens drying tumbler, energy label A. |
| Washing machine | 189 kWh | Siemens washing machine, energy label A+++. |
| Refrigerator | 175 kWh | Electrolux refrigerator, energy label A. |
| Freezer | 234 kWh | Siemens freezer, energy label A++ |
| Oven | 160 kWh | Husqvarna, energy label A. |
| 46" LED - SMART TV | 76 kWh | Philips 46 " LED-TV, energy label A+. |
| Other electric equipment | 1000 kWh | Estimated energy use for computers, other household equipment, etc. |
| SUM | 2388 kWh | |

4.3.3 Domestic hot water (DHW)

The normalized energy demand for DHW is according to NS3031 30 kWh/m²a. A grey water heat exchanger, illustrated in Figure 4.5, is estimated to have an efficiency of approximately 40 %. If we estimate that grey water from the dishwasher, showers/bathtubs and washing machine constitute 75 % of hot grey water, we can estimate a nominal efficiency of 30 %. However, there are heat losses in the greywater pipes, the greywater tank and a mismatch between the cold-water intake and supply of warm

grey water to and from the tank. This is assumed to reduce the effective efficiency to approximately 20 % and the DHW demand from 30 to 24 kWh/m² per year.

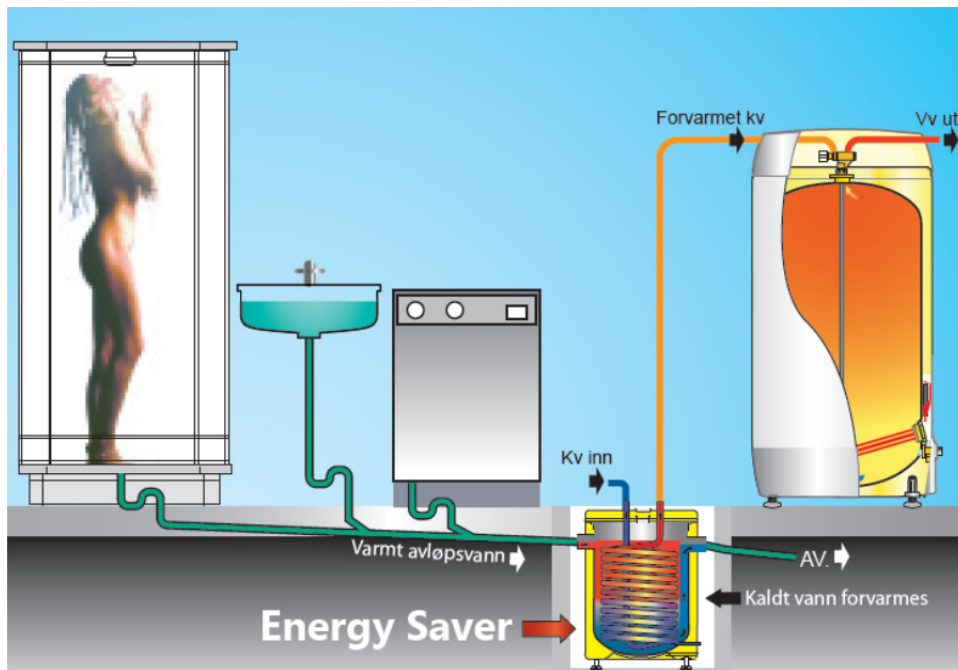

Figure 4.5 Grey water heat exchanger from OSO⁶.

⁶ <http://www.osohotwater.no/boligprodukter/energy-saver.html>

5. Energy Supply System

The energy supply solution for heating, cooling and electricity is an "all electric" solution based on:

- A combined system of an air to air heat pump and solar collectors covering the total heat demand, giving a high system COP⁷
- The electricity demand is covered by high efficiency PV on the roof

This solution is chosen due to its relatively mature technology, and it is a common solution on buildings with high energy ambitions (nearly zero, zero or plus energy houses).

5.1 Solar collector system

Vacuum tube solar collectors placed on the vertical south façade are designed to cover most of the heat demand (DHW and space heating)⁸ in the summer. Test data for vacuum collectors from APRICUS is used, with an optical efficiency of 69 % and first order U-value of 1.51 W/m²K. Other solar producers can deliver collectors with similar performance. The storage capacity is set to 600 litres. Calculation of solar production has been simulated with Polysun \5\). With 8.3 m² collector area (gross area) it covers 41 % of the total heat demand (DHW and space heating). The total solar thermal production of the system is calculated to be 3 374 kWh per year. Figure 5.1 shows how the solar collector and heat pump system cover the heat demand month-by-month. Due to its vertical position, the contribution from the solar collectors is significant also in the winter months, but also lower in the summer compared to roof mounted solar collectors.

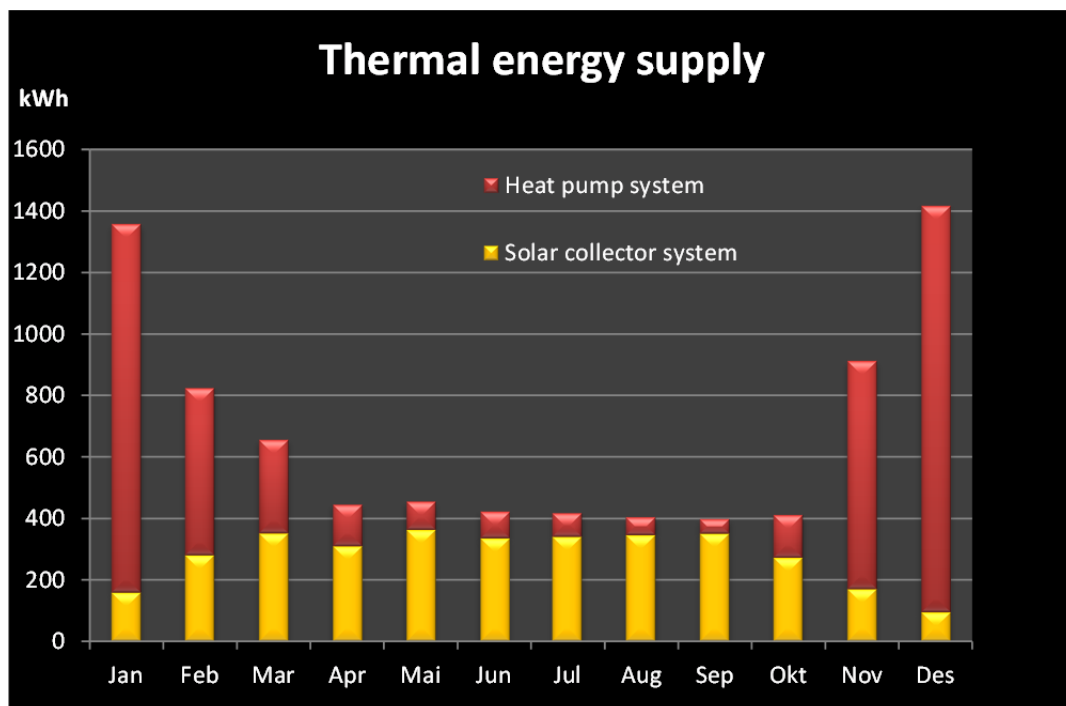

Figure 5.1 The monthly coverage of the heat demand by the solar collectors and the heat pump.

⁷ COP: Coefficient of Performance.

⁸ However, in these months there is little space heating demand, primarily DHW demand.

5.2 Heat pump system

The heat pump system is an air-to-water heat pump, using the outdoor air as a heat source. This is a varying heat source throughout the year, resulting in an annually varying COP. The data used in the simulation is AEOROTOP T07 from the Swiss manufacturer Elco. Assuming a delivered temperature from the heat pump of 45 °C, the monthly mean COP is given in Table 5.1. Based on annual delivered heat from the heat pump to the system, and its annual electricity need, the seasonal performance factor is 2.25.

Table 5.1 Monthly mean COP of the heat pump.

| Month (external temperature) | COP |
|------------------------------|-----|
| January (-3,7 °C) | 2.1 |
| February (-4,8 °C) | 2.1 |
| March (-0,5 °C) | 2.2 |
| April (4,8 °C) | 2.6 |
| May (11,7 °C) | 2.5 |
| June (16,5 °C) | 2.7 |
| July (17,5 °C) | 2.9 |
| August (16,9 °C) | 3.1 |
| September (11,5 °C) | 2.8 |
| October (6,4 °C) | 2.5 |
| November (0,5 °C) | 2.4 |
| December (-2,5 °C) | 2.2 |

Looking at both the solar thermal and heat pump as a total thermal system, an annual system COP (also called the Seasonal Performance Factor, SFP) becomes 3.8. More detailed simulation results from Polysun for the solar- and heat pump system is given in appendix B and D.

As seen in Figure 5.1 the heat pump system is the dominating heat supply the 4 coldest months, but the solar collectors is the dominant heat supply from April to October.

5.3 PV-system

A typical way to organize PV-panels on a flat roof is to have arrays of south facing panels with optimal tilt (around 30-45 degrees for Nordic conditions). However, with the low solar height in Norway, either you have to have large space between arrays or you get significant self-shading. An alternative way to solve this is to have panels with a low tilt (10-15 degrees) alternating facing south and north. To analyze this we have chosen a module from the manufacturer SunPower (SPR-333NE-WHT-D). This is a monocrystalline cell type with a very high nominal efficiency (20.3 %). The module is 1.56 m high and 1.05 wide. To maximize the solar output of the roof, the south facing PV has standing modules with a tilt of 10 degrees, and the north facing has laying modules with a tilt of 15 degrees. This gives a possibility of 3 south facing arrays of 10 modules in each array (10.5 meter long), and 2 north facing arrays of 6 modules in each array (9.4 meter long). A total of 49 m² south facing PV and 20 m² north facing PV are achieved with this arrangement.

A 10 degree south facing panel gives an annual flux⁹ of 1 023 kWh/m²a, while the 15 degrees north facing gets 777 kWh/m²a. In the coldest months, snow could cover the PV-panels, resulting in reduced

⁹ The optimal solar flux for Oslo climate is 1 081 kWh/m²a, for a south facing surface with a 39 degree tilt. Data from Meteonorm (www.meteonorm.com)

or eliminated solar electricity production. To get rid of the snow in the wintertime, a 68 cm gap between each array is made, which also makes it possible to go between the arrays for maintenance etc., see Figure 5.2.

The performance of the PV-system has been simulated with the tool PV-syst \6\). The south facing modules produce 8 730 kWh on an annual basis, while the two arrays towards the north produces 2608 kWh, giving a total of 11 338 kWh/a. This is equivalent to 71 kWh per square metre floor area per year. A more detailed simulation result from PV-syst is shown in Appendix C.

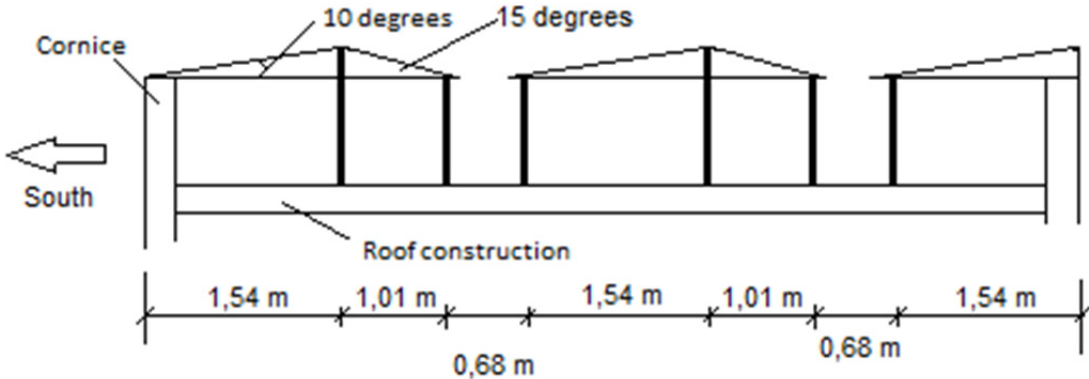

Figure 5.2 Arrangement of PV on the flat roof.

6. Embodied energy and green house gas emissions

6.1 Method

This chapter describes the calculations of the embodied emissions of the materials used in the residential concept model presented in this report. The analysis has not considered minimising the embodied emissions, only the documentation of the embodied carbon dioxide emissions using traditional materials in the envelope, ventilation & heating systems, as well as those associated with the renewable energy system, such as the photovoltaic panels and solar thermal units.

The 3D architectural drawings and 3D BIM modeling have been done in Revit version 2012. Embodied emission calculations have been done in MS Excel using data extracted from the LCA database Ecolnvent version 2.2 \3\). The results for these emissions calculations are presented using the IPCC Global warming potential 2007, 100 years scenario for CO₂ emissions. Material inventories have been imported from the Revit BIM model, via MS Excel. The material inputs are structured according to the Norwegian table of building elements, NS 3451-2009 \12\).

6.1.1. Goal and scope

The goal of these calculations is to estimate, and thus provide an overview of the materials and components in the ZEB residential concept model, which contribute the most to the embodied carbon dioxide emissions. The calculations are based on the principals of environmental assessment through life cycle analysis. It should be noted that in this first round of calculations, not all life cycle phases are included.

In the next stage of the calculations, the model will be optimised and the impact on emissions recalculated accordingly. In parallel to this optimisation work, the current model will be simplified to conform to current TEK 10 building standard components and the corresponding emissions will be calculated. This TEK 10 model can be used as a reference case. The current ZEB model can be used as a base case against which, further steps to optimise the design and corresponding impact on emissions can be compared.

6.1.1.1 Functional unit

The functional unit is 1 m² of heated floor area (BRA) in the residential building over an estimated life time for the building of 60 years. The heated floor area is 160 m². The results are mainly presented for emissions on an annual basis, where the functional unit of 1 m² is divided by 60 years.

6.1.1.2 Boundaries

The boundaries for the analysis are limited to the extraction of raw materials and the manufacturing of the main products and materials needed. Replacement of new materials over the lifetime has also been included. The expected service lifetime used for the different materials and components is listed in the inventory table attached in the appendix named Material Inventory for LCA. The estimated service lifetime of the different inputs is mainly based on product category rules for different materials and components.

Most of the materials and components used are analysed with respect to the environmental load of the production to gate. Technical installations have been included based on estimations as described in section 6.3.1. Chemicals such as glue –paint and primers are not included in the analysis.

The analysis focuses on module A1-A3 from the standard EN15978 \13\ that is material inputs to gate. The use phase B4, replacements, is also included. The different life cycle stages for a building according to EN15978 are shown in Figure 6.1.

| A1-3 PRODUCT STAGE | | | A4-5 CONSTRUCTION | | B1-7 USE STAGE | | | | | C1-4 END OF LIFE | | | |
|-----------------------|-----------|---------------|----------------------|-----------------------------------|-------------------|-------------|--------|-------------|---------------|-----------------------------|-----------|------------------|----------|
| A1 | A2 | A3 | A4 | A5 | B1 | B2 | B3 | B4 | B5 | C1 | C2 | C3 | C4 |
| Raw material supply | Transport | Manufacturing | Transport | Construction installation process | Use | Maintenance | Repair | Replacement | Refurbishment | De -construction demolition | Transport | Waste processing | Disposal |

Figure 6.1 Stages A1-3 and stage B4, according to EN15978, have been included in this analysis

6.1.1.3 Electricity mix

The choice of different electricity mixes used in the production of the materials used in the ZEB concept model can have a decisive influence on the results. The calculations presented here are not based on any single emission factor for electricity but instead are based on the Ecolnvent database, where the electricity mix used in the different processes is unchanged. For example, the concrete used in the analysis is based on a concrete process from Switzerland with the Switzerland electricity mix as an input. The solar cells production is based on the UCTE¹⁰ electricity mix, average European mix. Further work on the ZEB-residential concept model will include different scenarios for the electricity mix and applying the ZEB emissions factor where suitable. The impact on emissions will thus be assessed.

6.2 Life cycle inventory - Using BIM

The embodied calculations are based on the material inputs quantities provided from the building information module REVIT/BIM (Architecture) made for the ZEB residential model presented in this report. Length-area and volume of different materials and components have been exported from the REVIT/BIM (Architecture) model to excel and then the quantities have been used in the calculations to calculate the embodied emissions. The detailed dimensions of the material inputs has simplified the life cycle inventory phase and improved the level of detail of the material inputs.

The excel lists from the BIM can include a large amount of additional information for each specific material input. Processing the lists and interpreting the BIM volumes, as a basis for the quantities for each material to be used in the analysis, has been a large learning curve. Table 6.1 shows the BIM output is for different material components.

When working with BIM it is easy to visualize the material inputs which assists with the understanding of the inputs needed, quantities and to identify possible mistakes between BIM and the drawings. The level of details in the model, reflect the levels of details you get out regarding the material inputs. This information requires some interpretation and cross checking with the specification drawings.

¹⁰ The Union for the Co-ordination of Transmission of Electricity coordinates the operation and development of the electricity transmission grid for the Continental European synchronously operated transmission grid. <https://www.entsoe.eu/the-association/history/ucte/>

Table 6.1 Excel list showing BIM output for materials volumes for the groundwork & foundation, roof and structural decks
 (Note: text in red indicates additional modification required to accurately interpret the BIM quantities)

| Floor Material Takeoff (BIM) | | | | | | Further Data Modification | |
|---|---|---|----------------------------------|---------------------------|-----------------------------|--|---------------------------|
| Type Mark | Description | Material: Name | Material: Area (m ²) | Material: Description | Material: BIM Volume | Material Actual Volume (m ³) | Notes |
| Concrete floor | Concrete floor with Glava foundation system 520 TG 2602 | Concrete - Cast In Situ | 84 m ² | | 4.212 m ³ | 8.4 | <i>BIM VOL X 2</i> |
| <i>Roof load bearing system and interior cladding</i> | <i>Roof load bearing system and interior cladding</i> | <i>Misc. Air Layers - Air Space</i> | 82 m ² | <i>Air gap</i> | 1.891 m ³ | 0 | |
| Roof load bearing system and interior cladding | Roof load bearing system and interior cladding | Plasterboard | 82 m ² | Gypsum board | 1.069 m ³ | 1.069 | |
| Roof load bearing system and interior cladding | Roof load bearing system and interior cladding | Wood - Timber | 82 m ² | | 32.884 m³ | 5.36 (massive) | <i>Weight ratio (2,3)</i> |
| Wooden trusses | Wooden trusses | Wood - Timber(floor truss beam) | 75 m ² | | 22.384 m ³ | 3.656 (massive) | <i>Weight ratio (2)</i> |
| Floor separations | Floor between 1 st and 2 nd floor | Air Barrier - Air Infiltration Barrier (insulation) | 75 m ² | | 22.384 m ³ | 18.74 | |
| Floor separations | Floor between 1 st and 2 nd floor | Plasterboard | 75 m ² | Gypsum board | 0.970 m ³ | | |
| Floor separations | Floor between 1 st and 2 nd floor | Wood - Flooring | 75 m ² | | 1.045 m ³ | | |
| Floor separations | Floor between 1 st and 2 nd floor | Wood - MDF, Medium Density Fibreboard | 75 m ² | | 1.641 m ³ | | |
| Floor separations | Floor between 1 st and 2 nd floor | Plastic | 75 m ² | | 0.119 m ³ | | |
| Floor separations | Floor between 1 st and 2 nd floor | Wood - Pine | 75 m ² | Facade material | 1.716 m ³ | 0.137 | |
| Concrete and insulation | Glava foundation system 520mm TG 2602 | Concrete - Cast In Situ | 20 m ² | | 4.929 m ³ | 21 | |
| Concrete and insulation | Glava foundation system 520mm TG 2602 | Concrete - Cast In Situ | 9 m ² | | 4.870 m ³ | 2.46 | |
| Insulation | Insulation and vapour barriers TG 2602 | Insulation / Thermal Barriers - Rigid insulation | 168 m ² | | 16.843 m ³ | 42.1 | |
| Insulation | Insulation and vapour barriers TG 2602 | Vapour / Moisture Barriers - Damp-proofing | 84 m ² | Tyvek or similar | 0.168 m ³ | | |
| Roof insulation | Roof insulation | Insulation / Thermal Barriers - Rigid insulation | 169 m ² | | 35.133 m ³ | 35,133 | |
| Roof insulation | Roof insulation | Vapour / Moisture Barriers - Damp-proofing | 85 m ² | Tyvek or similar | 0.169 m ³ | 0,69 | |
| Roof insulation | Roof insulation | Roofing - Asphalt | 85 m ² | Exterior roofing | 0.330 m ³ | 0,33 | |
| | | <i>Missing from BIM - add mdf board roof (22mm)</i> | 82 m ² | <i>mdf particle board</i> | 1,8 m ³ | 1,8 m ³ | |

When working with BIM it is easy to visualize the material inputs which assists with the understanding of the inputs needed, quantities and to identify possible mistakes between BIM and the drawings. The level of details in the model, reflect the levels of details you get out regarding the material inputs. This information requires some interpretation and cross checking with the specification drawings.

For example, it can be seen in Table 6.1 that the *BIM* volume for wood truss beam in the roof was 32.8 m³ whereas it was found that the *actual* volume of wood was 5.36 m³. In the example given, the BIM volume for the structural wood trusses in the structural decks and outer roof are based on a solid mass of wood, but in reality this mass comprises of a series of wooden beams. The quantity of wood has to be calculated by applying an estimated weight ratio of 2, 3 to estimate the actual weight of wood in each wooden truss. Without these further steps and interpretation of the quantities, there would be a six fold over-estimation of emissions for the structural wood.

In addition, due to a limitation of the BIM architecture (rather than BIM structural) programme, the structural wood (k-stud) quantities in the outer and inner walls are not included in the BIM output. Therefore, the quantity of structural wood in these building components has to be estimated. In this case the estimation is based on an estimate of 12% of the insulation volume.

Another aspect of the learning curve in transforming the BIM volumes for use in LCA analysis, has been to organise the material names contained in the BIM output to the corresponding category in the Norwegian standard NS 3451 \12\ - Table of building elements in order to facilitate compatibility with BIM/REVIT.

This organisation of the modified BIM data is shown overleaf in Table 6.2.

Table 6.2 Excel list showing the calculated emissions for the different building components contained in the Table of Building Elements NS 3451:2009.

| Scope | | | | | |
|--|--|--|---|---|--|
| Systemboundary | Cradle to gate | | | | |
| Lifetime of construction | 60 | years | | | |
| BRA | 160 | m ² | | | |
| Functional unit (FU) | 1 m ² BRA over the lifetime of 60 years | | | | |
| Building element | | [kgCO _{2eq}] <i>Lifetime 60 years</i> | [kgCO _{2eq}] <i>per year</i> | [kgCO _{2eq} /m ² BRA] <i>Lifetime 60 years</i> | [kgCO _{2eq} /m ² BRA] <i>per year</i> |
| 2 Building | | | | | |
| | 21 Groundwork and foundations | 14067,19 | 234,45 | 87,92 | 1,47 |
| | 22 Superstructure | 1376,00 | 22,93 | 8,60 | 0,14 |
| | 23 Outer walls | 12686,88 | 211,45 | 79,29 | 1,32 |
| | 24 Inner walls | 3550,84 | 59,18 | 22,19 | 0,37 |
| | 25 Structural deck | 3685,02 | 61,42 | 23,03 | 0,38 |
| | 26 Outer roof | 4174,10 | 69,57 | 26,09 | 0,43 |
| | 28 Stairs, balconies etc. | 0,00 | 0,00 | 0,00 | 0,00 |
| | 29 Other | 6229,59 | 103,83 | 38,93 | 0,65 |
| 3 Heating, ventilation and sanitation | | | | | |
| | 36 Ventilation and airconditioning | 492,41 | 8,21 | 3,08 | 0,05 |
| 4 Electric power | 49 Other electric power installations | | | | |
| | <i>Photovoltaic panel, single Si, at plant/RER</i> | 20625,48 | 343,76 | 128,91 | 2,15 |
| | <i>Evacuated tube collector, at plant /GB</i> | 2252,21 | 37,54 | 14,08 | 0,23 |
| 5 Telecommunication and automatisation | | 0 | 0,00 | 0,00 | 0,00 |
| 6 Other installations | | 0 | 0,00 | 0,00 | 0,00 |
| 7 Outdoor | | 0 | 0,00 | 0,00 | 0,00 |
| | TOTAL | 69139,71 | 1152,33 | 432,12 | 7,20 |
| | Initial material use (<i>no replacement</i>) | 50422,00 | 840,37 | 315,14 | 5,25 |
| | Use phase replacements | 18717,71 | 311,96 | 116,99 | 1,95 |

Table 6.3 Excel list showing the calculated emissions for the different building materials.

| Materials | Lifetime | Density (kg/m ³) | Emissions (kg CO _{2eq}) 60 year lifetime | Emissions (kg CO _{2eq}) per m ² 60 year lifetime | Emissions (kg CO _{2eq}) per m ² per year |
|---|----------|------------------------------|--|---|---|
| Concrete | 60 | 2380 | 8333,56 | 52,08 | 0,87 |
| Rigid Insulation (EPS) | 60 | 30 | 7979,61 | 49,87 | 0,83 |
| Damp proof membrane (LDPE) | 60 | 940 | 1367,98 | 8,55 | 0,14 |
| Parkett Wood flooring (Missing BIM input) | 15 | 715 | 204,32 | 1,28 | 0,02 |
| Radonmembrane ISOLA (Missing BIM input) | | | 0,00 | 0,00 | 0,00 |
| Insulation TG2387 (Missing BIM input) | | | 0,00 | 0,00 | 0,00 |
| Load bearing Steel Beam | 60 | 7850 | 1376,00 | 8,60 | 0,14 |
| Timber (Structural) | 60 | 765 | 853,34 | 5,33 | 0,09 |
| Insulation (Glass wool) | 60 | 40 | 5328,42 | 33,30 | 0,56 |
| Gypsum Plasterboard | 60 | 900 | 2771,06 | 17,32 | 0,29 |
| Wind barrier (kraftpapier) | 60 | 650 | 391,07 | 2,44 | 0,04 |
| Door + Window Frame (Wood) | 30 | 495 | 127,03 | 0,79 | 0,01 |
| Window (Flat Glass) | 30 | 2500 | 1727,65 | 10,80 | 0,18 |
| Parapet (Cembrit) | 30 | 1800 | 588,60 | 3,68 | 0,06 |
| Parapet (MDF) | 30 | 780 | 1456,17 | 9,10 | 0,15 |
| Cladding (wood) | 30 | 500 | 171,45 | 1,07 | 0,02 |
| Ceramic Tiles | 60 | 1900 | 1810,36 | 11,31 | 0,19 |
| Roof membrane (asphalt) | 30 | 2100 | 62,37 | 0,39 | 0,01 |
| OSB plate | 60 | 594 | 566,68 | 3,54 | 0,06 |
| Ventilation Ducts (steel) | 60 | | 492,41 | 3,08 | 0,05 |
| Solar Thermal | 20 | | 2252,21 | 14,08 | 0,23 |
| Pv panel | 30 | | 20625,48 | 128,91 | 2,15 |
| Hot water tank (OSO EP2 400) | 30 | | 1301,06 | 8,13 | 0,14 |
| Heat Pump (Boch EHP 7 LW/M) | 20 | | 4578,00 | 28,61 | 0,48 |
| Heat Pump Refrigerator fluid (R-407) | 60 | | 139,05 | 0,87 | 0,01 |
| (Heating System) PEX - High density polyethylene (HDPE) | 60 | | 42,92 | 0,27 | 0,00 |
| (Heating System)Steel | 60 | | 168,56 | 1,05 | 0,02 |

An example of the detail of information contained in each component is shown below for section 26 Outer Roof. This cross references to the BIM volume file for quality assurance and is not shown in this extract from the file.

Table 6.4 Excel list showing the level of detail for Section 26 Outer Roof contained in the table of building element.

| Building elements | | Input data | | | | | | | | | | Embodied CO ₂ (Lifetime 60 years) | | |
|---------------------|--------------------------|------------|--------------------------------------|---|---|------------------------------|--------|----------------|----------------|--------------|------------------|---|---------------------|---------|
| | | Nr. | Material input | Process used | Lifetime | Density [kg/m ³] | Amount | Unit | Mass [kg] | Weight Ratio | Actual Mass [kg] | kgCO _{2eq} /kg | kgCO _{2eq} | |
| 26 Outer roof | 261 Primary construction | 2611 | Wood Roof Truss Beam (Gitterbjelker) | Massivholz Fichte / Tanne / Lärche, Skandinavien, sägerau, entrindet (EMPA - row 297) | 60 | 715 | 5,36 | m ³ | 3832,4 | 2,3 | 1666 | 0,09 | 149,96 | |
| | 262 Roof Covering | 2621 | Membrane | Asfalt (ATB) (Asphaltdeckschicht - EMPA row 438) | 30 | 2100 | 0,33 | m ³ | | | 693 | 0,09 | 124,74 | |
| | | | 2623 | Plywood | OSB/ 3 plate (15mm) (EMPA row 299) | 60 | 594 | 1,8 | m ³ | | | 1069,2 | 0,53 | 566,68 |
| | | | 2622 | Insulation | EPS 400mm (0,036 W/Mk) (EMPA row 336) | 60 | 18 | 35,133 | m ³ | | | 632 | 4,21 | 2662,38 |
| | | | 2624 | Vapour Barrier | PE Foil (0,2mm) Tyvek el. tilsvarende | 60 | 940 | 0,169 | m ³ | | | 158,86 | 2,1 | 333,61 |
| | | | 2625 | Gypsum | Gypsum plaster board (13mm), at plant/CH | 60 | 900 | 1,069 | m ³ | | | 962,1 | 0,35 | 336,74 |
| | | | | MDF (missing from drawing & BIM) | Medium density fibreboard, at plant/m3/RER (EMPA) | 60 | 780 | | m ³ | | | 0 | 0 | 0,00 |

In several cases, the material in question, for example, structural wood is used in several building components such as in the structural decks and the roof, which is divided into different construction parts. There is an additional step required to manually take the quantities of materials from BIM excel sheet and input it into the correct category in the table of building elements NS 3451 \12\). Such a table makes it much easier to organize the data. Also, the level of detail allows for detailed modeling in Excel, and simplifies the manual work, when changes are made. The architect has specified the name, description and type of the material input in the list. This is helpful when trying to identify suitable material processes from Ecoinvent.

The amount of load bearing steel beam is not included in the model, therefore the amount of 800 kg is based on estimates done by SINTEF. The density and emission factor are taken from Ecoinvent database.

The level of detail in the model does not include the quantities for electrical cables, nails nor any steel studs and are therefore not accounted for at this stage.

6.3 Life cycle inventory – environmental data, technical installations and simplifications

The material inputs are mainly based on environmental data from the Ecoinvent database version 2.2. All material inputs and information on Ecoinvent processes used are listed in Appendix D.

6.3.1 Technical installations

Technical installations at this stage of the calculations include ventilation, heating system and the solar PV system and thermal collectors. In this analysis the following estimates for the masses in the material inventory for the technical installations are included:

- **Ventilation** – quantities and materials used in the ducts (125 mm, 160 mm, and 200 mm), the air handling unit, kitchen fan unit and combined intake/exhaust based on published literature and input from other authors in this report.
- **Heating** - hot water tank (OSO EP2 400) and heat pump (Boch EHP 7 LW/M) and Refrigerator fluid (R-407).
- **Solar thermal panels** (APRICUS AP30) – 8.3 m² vacuum collectors , process from Ecoinvent, 20 year lifetime, with an estimate of 20 % for support structures
- **Solar PV panels** (SUNPOWER PV - SPR-333NE-WHT-D) mono crystalline solar cells¹¹ 30 years lifetime. Since an emission factor is unavailable in Ecoinvent, data has been extracted from the database for photovoltaic panel, Single Si, at plant/RER/I U. Total area of solar cells is based on 49 m² south facing PV + 20m² north facing PV = Total 69 m² of PV panels.

¹¹ Solar PV panel based on: *Solarpaneel, single-Si, ab Werk*

Unit process raw data for 1 m² of PV panel. Investigated for the production of solar panels and laminates with 60 solar cells a 156*156cm² with a capacity of 224 Wp. Cell size and amount and capacity might differ between different producers.; Geography: Production plants in Western Europe. UCTE electricity mix.

- An assumption is made that the solar cells produced in 2042 will be produced in a 50 % more material/energy efficient way.¹² Accordingly, the emissions for the PV panels will be: 20 625 kgCO_{2eq} instead of 27 500 kgCO_{2eq}.

[Note: This assumption is in line with that made in the ZEB Office concept model and is based on literature on the development of solar cell production and prognosis for the price development for PV panels etc. This may be an optimistic assumption, but at this preliminary stage of the calculations, we do not believe it is more correct to use the production data for PV panels in 2007 for panels that will be installed in 2042. This is issue needs to be addressed in the next stage of the research.]

6.3.2 Simplifications and uncertainty

The estimated service lifetime for the solar PV panels is 30 years and is based on guidelines from the IEA¹³ for the LCA of solar PV panels. The service lifetime for solar PV panels is uncertain and is dependent on the quality of the actual solar PV panels used.

The service life time of the different materials and components used, is also a very large uncertainty factor and needs further discussion. In this analysis the following inputs are not included:

- Material losses of building materials at site
- Estimates for electrical cables, steel studs and quantities of nails.

In addition, since the BIM output for solar collectors only included quantities for the aluminium component only, it was decided to take the area (m²) of both the PV panels (69 m², 30 year lifetime) and solar thermal collectors (8,3m², 20 year lifetime) and to source the respective emissions factors from the Ecoinvent database.

The hot water boiler (OSO EP2 400) has a capacity of 600L. Data was available in the Ecoinvent database for Hot Water Tank 600l, at plant, CH. The emissions are 650.53 kg CO_{2eq} per unit.

There was no data available in Ecoinvent database for the heat pump (Bosch EHP 7 LW/M). However, the product specification brochure was available which included a reference to GWP100= 1526. Direct contact was made with Bosch to ascertain the exact meaning of this reference although this did not provide much clarity. Rather than omit the emissions for the heat pump altogether at this stage of the calculations, it was assumed to mean that kg CO_{2eq} = 1 526 and the lifetime of the heat pump is assumed to be 20 years. Therefore, the total emissions for the 60 year lifetime of the calculations would result in (1 526 kg CO_{2eq} x 3 = 4 578 kg CO_{2eq} 60 year lifetime).

The refrigerator fluid (R-407) was specified for the heat pump. Emissions were sourced from Ecoinvent database for the nearest fluid which was refrigerator fluid (R134a) which had an emission factor of 103 kg CO_{2eq} /kg.

The mass inventory for heating included quantities for PEX piping (17 x 2mm) and the radiators located one on each floor. Emission factors were extracted from the Ecoinvent database for high density polyethylene (HDPE) for the PEX piping (2.33 kg CO_{2eq} / kg) and steel for the radiator (1.72 kg CO_{2eq} /kg).

¹² http://www.sense-eu.net/fileadmin/user_upload/intern/documents/Results_and_Downloads/SenseWorkshopLCAinGeneral.pdf

¹³Methodology Guidelines on Life Cycle Assessment of Photovoltaic Electricity http://www.iea-pvps.org/fileadmin/dam/public/report/technical/rep12_11.pdf

The material inventory provided the kg/m and weight (kg) for the steel used in the ventilation ducts (125 mm, 160 mm, and 200 mm), air-handling unit, kitchen fan unit and combination intake/exhaust. The Ecoinvent database provides an emission factor of 6.34 kg CO_{2eq} (Ventilation duct, steel, and 100x50 mm, at plant/RER U). The weight of the 100x 50 mm ventilation duct is 1.5 kg/m, so the emissions for the different specified steel ventilation components can then be scaled up according to weight as follows:

Table 6.5 Carbon dioxide emissions from material use for the ZEB-residential concept

| Material | | kg/m | kgCO_{2eq} |
|--|---|-------------|---------------------------|
| Ventilation duct, steel, 100x50 mm, at plant/RER U | 100mm x 50mm ducts (cross referenced from ZEB office concept) | 1,5 | 6,34 |
| | 200 mm DUCTS | 2,3 | 9,72 |
| | 160 mm DUCTS | 1,8 | 7,61 |
| | 125 mm DUCTS | 1,4 | 5,92 |
| | Air handling unit | 67 | 283,19 |
| | Kitchen fan unit | 40 | 169,07 |
| | Combi intake/exhaust | 4 | 16,91 |

6.4 Results

6.4.1 Carbon dioxide emissions

This section presents the results from the current inventory for the ZEB residential concept model. The total carbon dioxide emissions for the functional unit (m²) and per year are presented in Table 6.6 below. The carbon dioxide emissions are calculated to be 432 CO_{2eq} /m² over a lifetime of 60 years and approximately 7.2 kg CO_{2eq} / m² per year.

Table 6.6 Carbon dioxide (eq) emissions from material use for the ZEB-residential concept

| Phase | KgCO_{2eq} /m² | KgCO_{2eq}/m² per year |
|----------------------|--|--|
| Initial material use | 315 | 5.25 |
| Replacements | 117 | 1.95 |
| Total | 432 | 7.20 |

The results below show the total emissions per m² per year, the emissions associated with the initial material use and those associated with replacements over the estimated lifetime of 60 years.

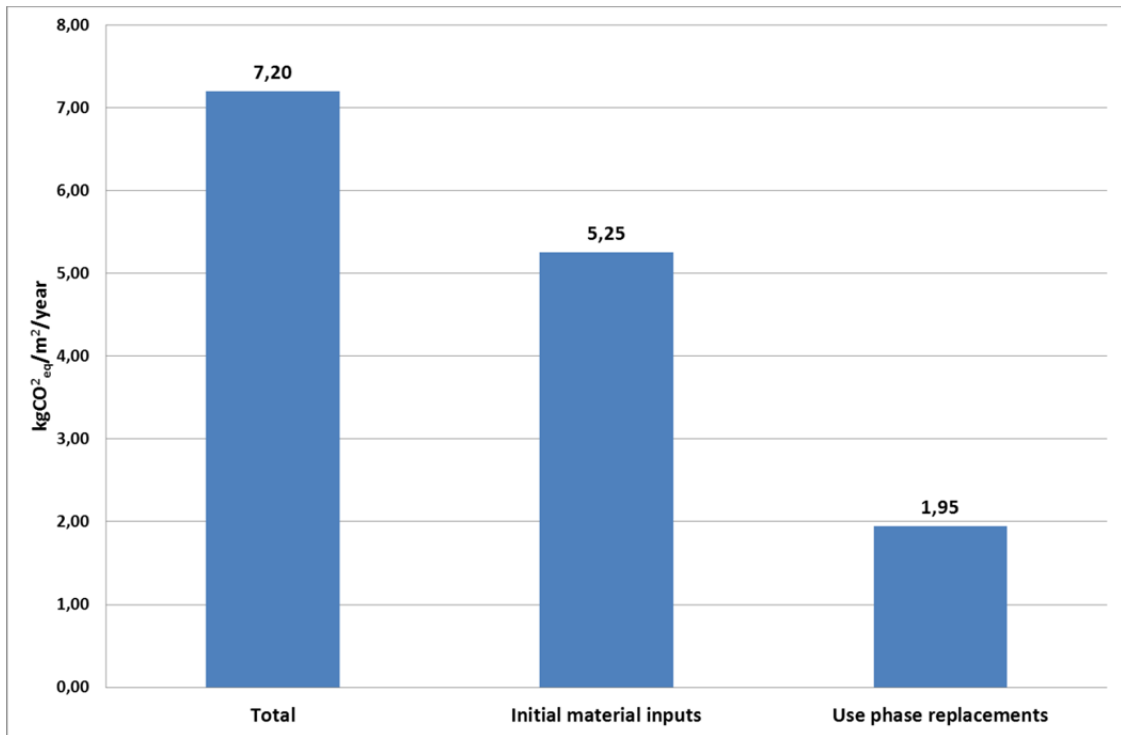

Figure 6.7 Total carbon dioxide emissions (kg CO_{2eq} per m² per year) and emissions associated with the pre-use phase (initial material input) and use phase replacement

From figure 6.8, it is clear that the photovoltaic panels, the groundwork + foundations and the outer walls are the largest contributors to the emissions.

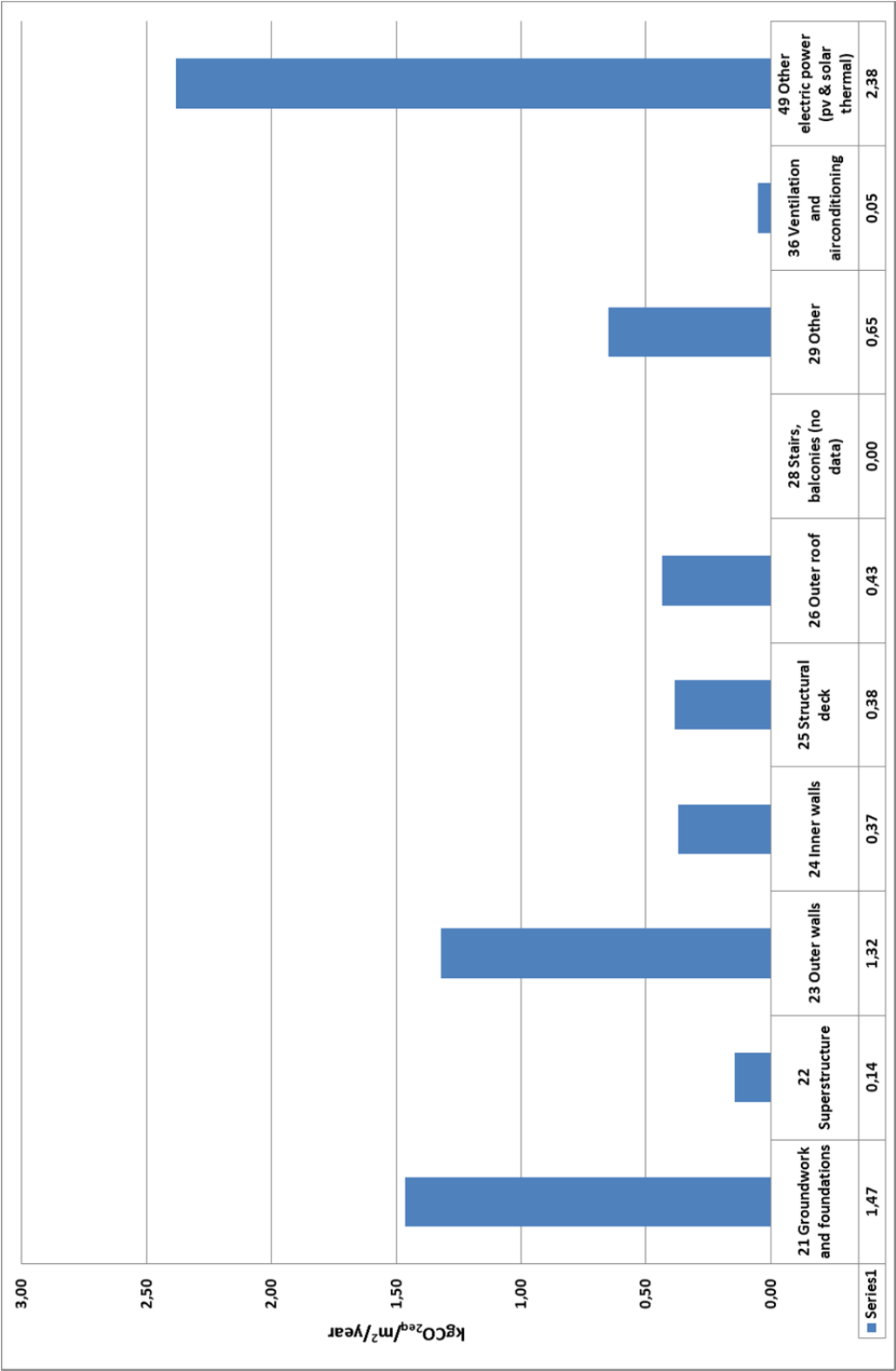

Figure 6.8 Carbon dioxide emissions (kgCO_{2eq}/m² per year) corresponding to each building component in the table of building elements.

[Note: Emissions are not included for section 28 Stairs. Section 36 Ventilation & Air-conditioning include emissions for steel ducts only.]

In Figure 6.9, the emissions from the main material inputs and technical installations are shown. It is clear that the photovoltaic panels, the concrete and the insulation are the largest contributors to the carbon dioxide emissions. The concrete exists in the section foundation and ground works and explains the large emissions from this section. Insulation is the other large contributor to emissions and this is caused by the use of EPS insulation in the ground floor slab and the roof. In addition, glass wool insulation is also used in the outer walls as well as insulation in the inner walls.

If the solar cells are not estimated to be produced in a 50 % more efficient way in 30 years, and the same EcoInvent process is used unchanged for the use phase the total emissions will be total 7.6 kg/m² per year or 0.7 kg higher. This indicates that the PV panels alone count for between 2.1-2.9 kg/m² per year or approximately 30-38 % of the current total emissions dependent on the replacement scenario.

It should be noted that the contribution from the concrete emissions are 261 kg CO_{2eq} /m³ ¹⁴ per year and are not based on low carbon concrete, therefore by replacing the normal concrete with low carbon concrete the emissions from concrete could be reduced significantly.

6.5 Summary

The main output of this research has been the demonstration and learning curve associated with the development and inter-operability of architectural programmes such as Revit/BIM with the Swiss LCI database Ecoinvent. This inter-operability of the tools is part of the development of a robust, flexible and transparent emissions calculation method for use as decision support at early design stage. Such application of the method to the shoebox model has demonstrated it can be used to assess the impact on emissions of different material choices and energy systems, as well as testing and ensuring consistency in environmental input data from both the shoebox design, BIM and Ecoinvent.

The main findings have shown that the emissions from PV panels account for 30-38% of the total emissions depending on the predicted production efficiency chosen. In the next stage of this research, the impact on total emissions of different lifetime and durability assumptions should be investigated in more detail. In addition, a series of scenario tests should be conducted to analyse the impact on emissions of the following;

- 1) Using Hybrid PV/T modules instead of separate PV panels and solar thermal collectors.
- 2) Comparing the emissions between the monocrystalline, single crystalline, silicon PV panel (199 kg CO_{2eq} /m²)¹⁵ used in this first round of calculations with less efficient thin film PV panels such as a-Si (73.8 kg CO_{2eq} /m²)¹⁶ and CIS (123 kg CO_{2eq} /m²)¹⁷ which are less energy intensive to produce and are less sensitive to over-heating.
- 3) Replacing normal concrete with green concrete.
- 4) Replacing glass wool insulation with emerging materials such as VIP, PCM, aerogel. The corresponding structural implications would also need to be considered.
- 5) For those materials known to be produced in Norway, such as concrete (Norcem, Unicon etc), aluminium etc, then the generic data from Ecoinvent should be replaced with specific data from Norwegian manufacturers. Attention should be taken in the extraction of the data from the EPD for example, boundary condition, year of the data, place of production of the material. Where

¹⁴ Concrete, normal, at plant/CH U

¹⁵ Photovoltaic panel, single-Si, at plant/RER/I U

¹⁶ Photovoltaic panel, a-Si, at plant/US/I U

¹⁷ Photovoltaic panel, CIS, at plant/DE/I U

possible, it is best to calculate the emission factor by use the kWh for production and multiplying it by the ZEB emission factor (132g CO₂/kWh) \14\ which takes into account the exchanges of electricity to and from Norway and future changes in the electricity grid.

Despite the fact that this first round of calculations has presented many challenges and a large learning curve and interpretation of data involved, it is expected that future optimization of the design will be much less challenging.

7. Energy and CO₂ Calculations

The analysis in this chapter follows the following structure:

1. First calculation of the net energy budget (net demand).
2. Splitting of the demand into electric, thermal heating and thermal cooling demand
3. Calculation how the energy supply meets the thermal demand (heating and cooling)
4. Calculation of the gross delivered energy, and the related CO₂-emissions for operation
5. Calculation of the CO₂ from both operation and embodied emission.
6. Design of the on-site electricity production, and calculation of the total CO₂ balance

Point 6 gives the answer if the PV-production meets the (different) ZEB-definition levels given in paragraph 1.5.

7.1 Net energy budget

The total net annual energy demand, as defined in NS3031 \10\, is 70 kWh/m²a (11 338 kWh/a). This is a very low number for a residential building, but is based on state-of-the-art technology as described in the foregoing chapters. Figure 7.1 gives the annual demand for different energy items (purposes), with domestic hot water (DHW), space heating and appliances as the largest energy users.

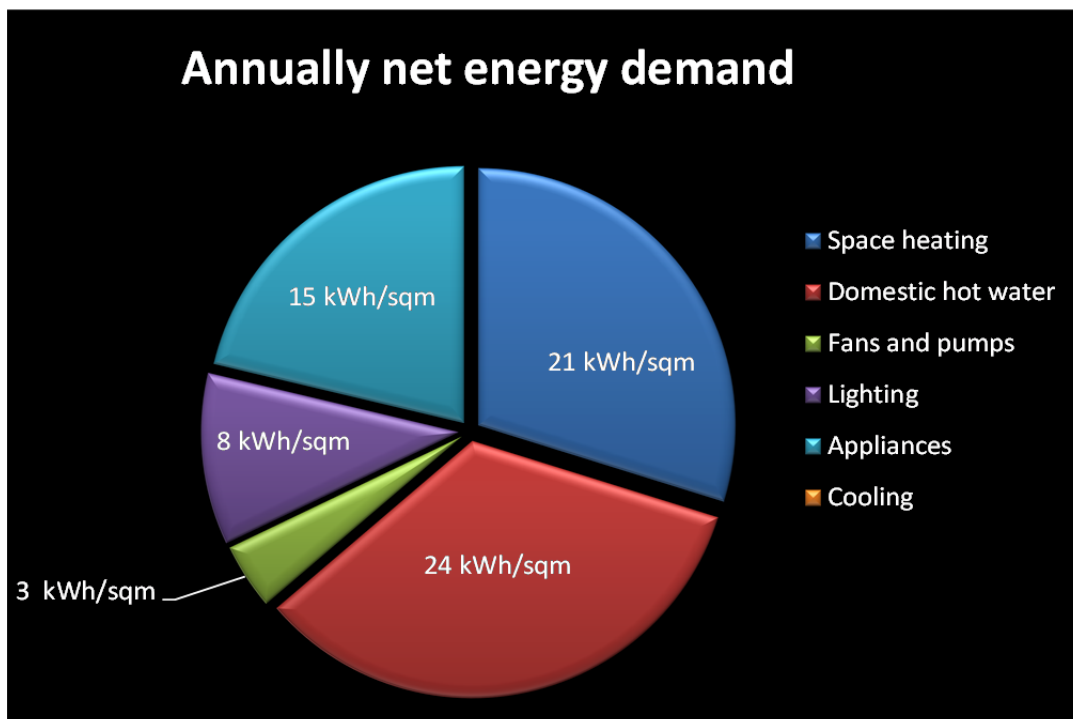

Figure 7.1 Annual net energy demand (budget) according to NS3031 \10\.

7.2 El-specific and thermal demand

As seen by Figure 7.2 the largest demand is the thermal demand with 64 %.

The DHW and space heating demand is nearly equal on an annual basis, but is of course varying differently as shown in Figure 7.3. As expected the el-specific demand is quite constant over the year¹⁸, as shown in Figure 7.4.

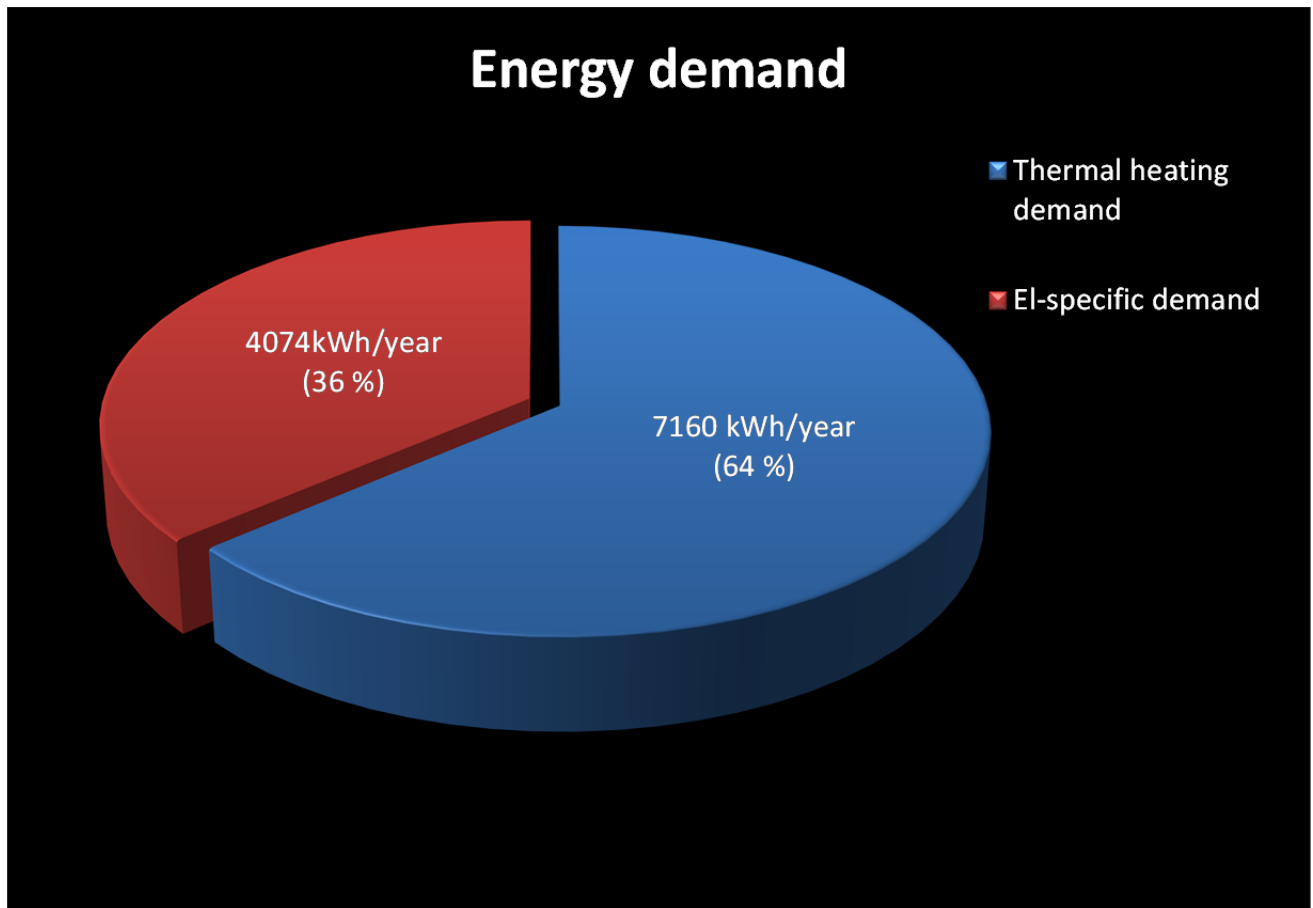

Figure 7.2 The annual demand split into thermal (heating and cooling) and el-specific demand.

¹⁸ According to NS3031 a year round operation of residential building is assumed, and the load from lighting and appliances is also assumed constant over the year. It can be discussed how realistic this is, and will be further elaborated in a future concept work in ZEB.

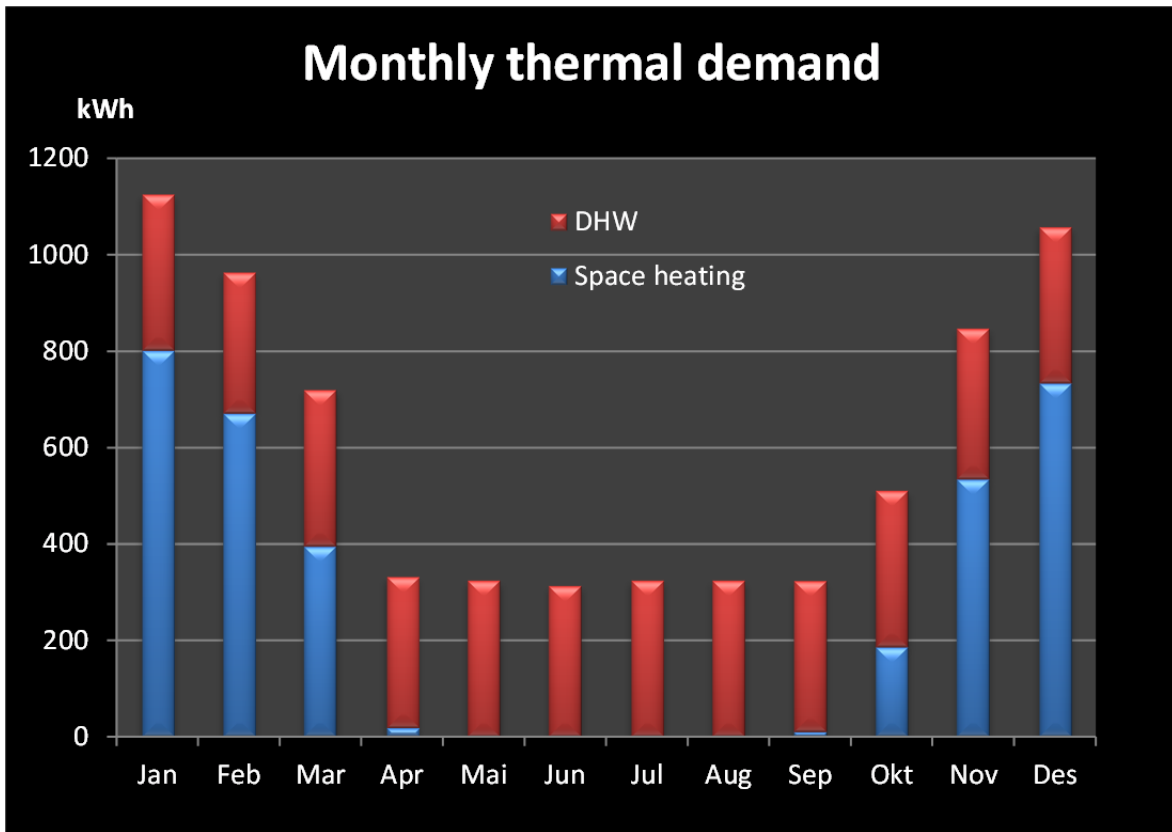

Figure 7.3 The annual variation in thermal heat demand (DHW and space heating).

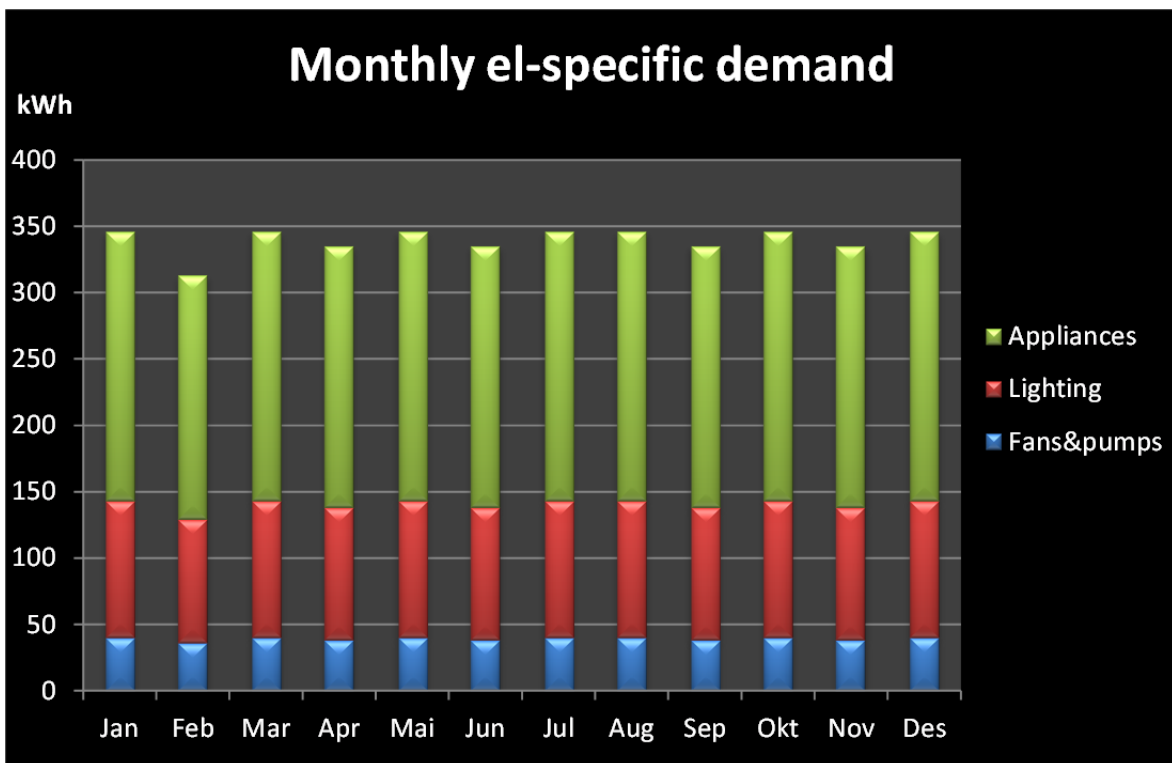

Figure 7.4 The annual variation in the el-specific demand.

7.3 Thermal energy supply system

As described in chapter five the thermal heating demand is covered by a combined solar collector and aero thermal heat pump system. The solar collector system covers mainly the domestic hot water (DHW) demand in the summer months (roughly April-October), while the heat pump system cover mainly the space heating demand and the DHW demand in winter.

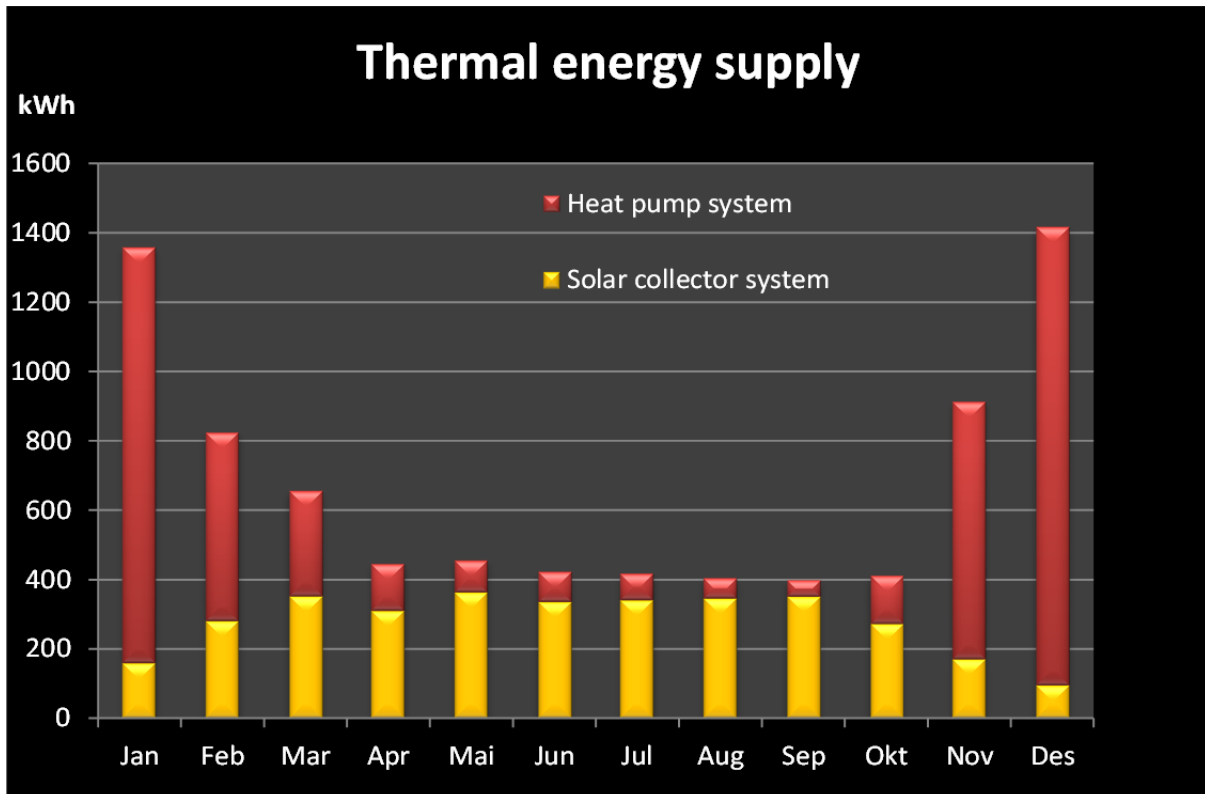

Figure 7.5 The annual variation in heat energy supply from the solar collectors and the heat pump system.

Due to a very small energy demand for pumps in the solar system, the electricity need for the thermal supply system is totally dominated by the heat pump system, with an annual need of 2 107 kWhel. The solar system only needs 30 kWhel on an annual basis

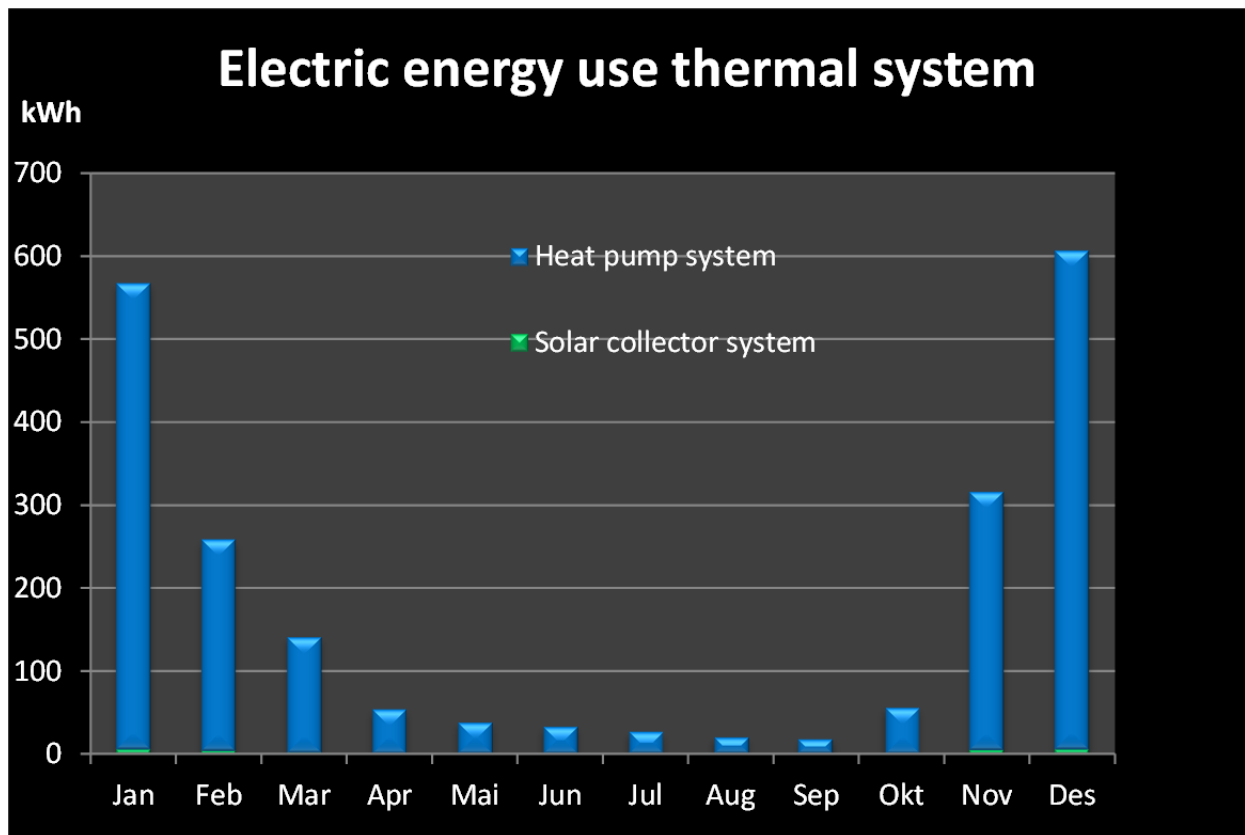

Figure 7.6 The annual variation in electricity needed for the thermal energy supply system.

7.4 Gross delivered energy and related CO₂ emissions

Summation of the el-specific energy demands in paragraph 7.2 and the electric needs for the thermal system in paragraph 7.3, gives the total delivered electricity for the building, as shown in Figure 7.7. However, this does not take into account the PV electricity production, and is therefore referred to as gross delivered electricity. The main drivers for delivered electricity are appliances (39 %), the heat pump system (34 %) and lighting (20 %). The total annual delivered electricity is 39 kWh/m² (6 211 kWh per year).

Since all (gross) delivered energy is electricity the CO₂ emissions from operation is proportional to the delivered energy, as shown in Figure 7.8. The total annual CO₂ emission for (gross) operational energy is 5.0 kg/m² (807 kg per year).

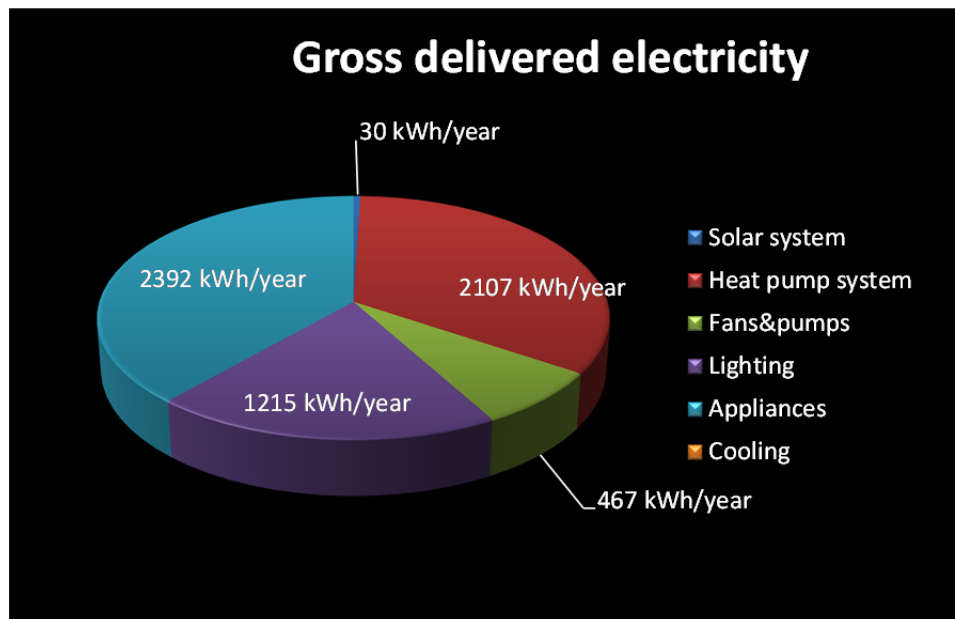

Figure 7.7 Annual gross delivered electricity for the building.

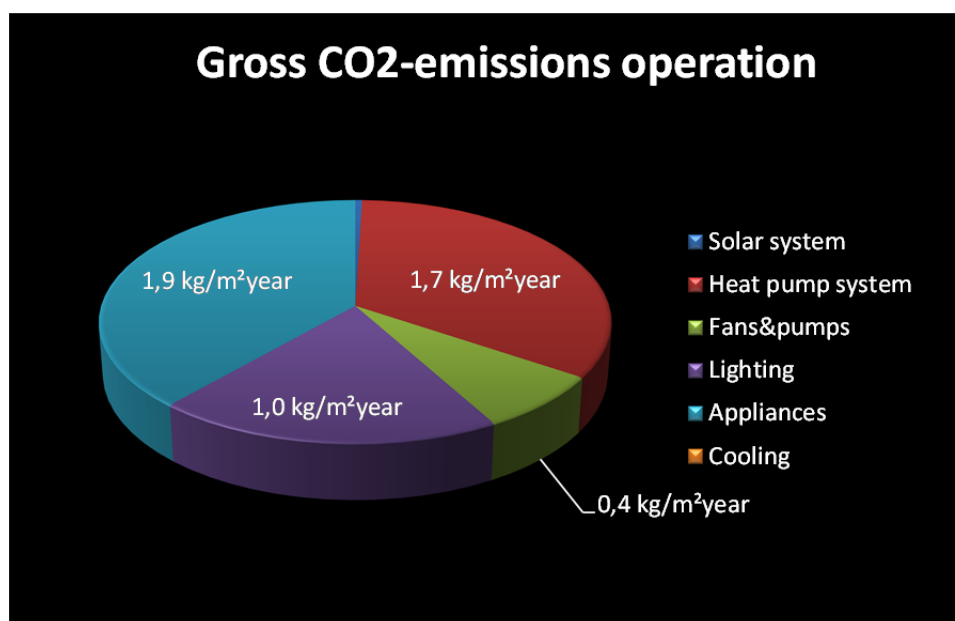

Figure 7.8 Annual gross CO₂ emissions due to operational energy use.

7.5 Embodied and total CO₂ emissions

Embodied CO₂ emissions for the building, as calculated in chapter 6, is shown in Figure 7.9. The total emission amounts to 7.2 kg/m²a. PV-modules, external walls and foundation are the largest contributors to the emission.

According to the preliminary estimate, embodied emissions constitute 59 % of the total emissions, as shown in Figure 7.10. The total CO₂ emissions that has to be balanced by PV-production is 12.3 kg/m²a, to reach the ZEB-OM level (see section 1.5).

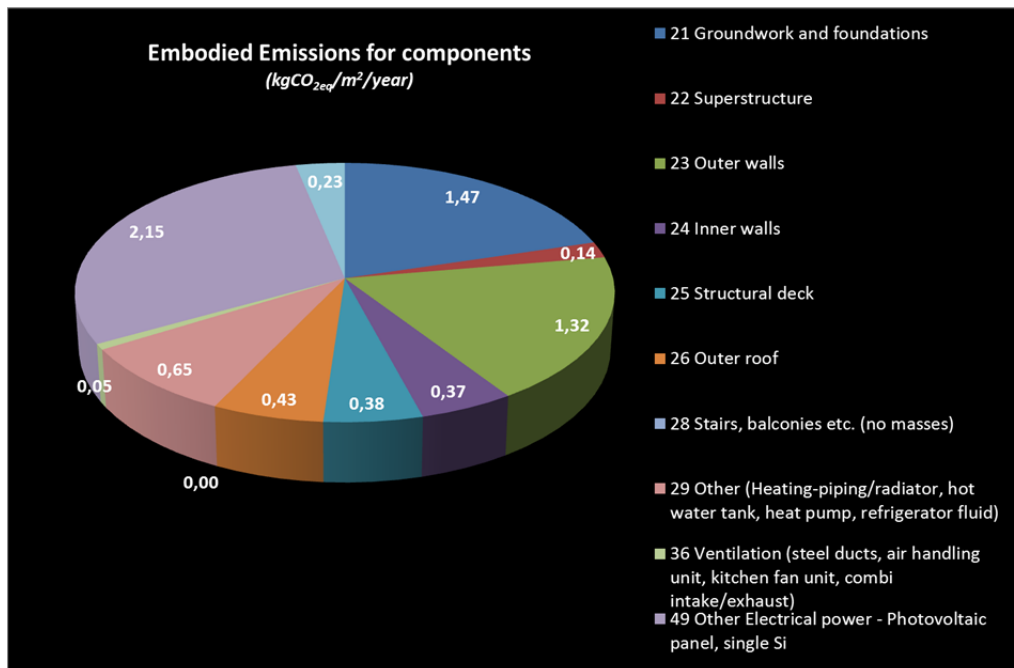

Figure 7.9 Embodied CO₂ emissions corresponding to different buildings elements (according to NS 3451)

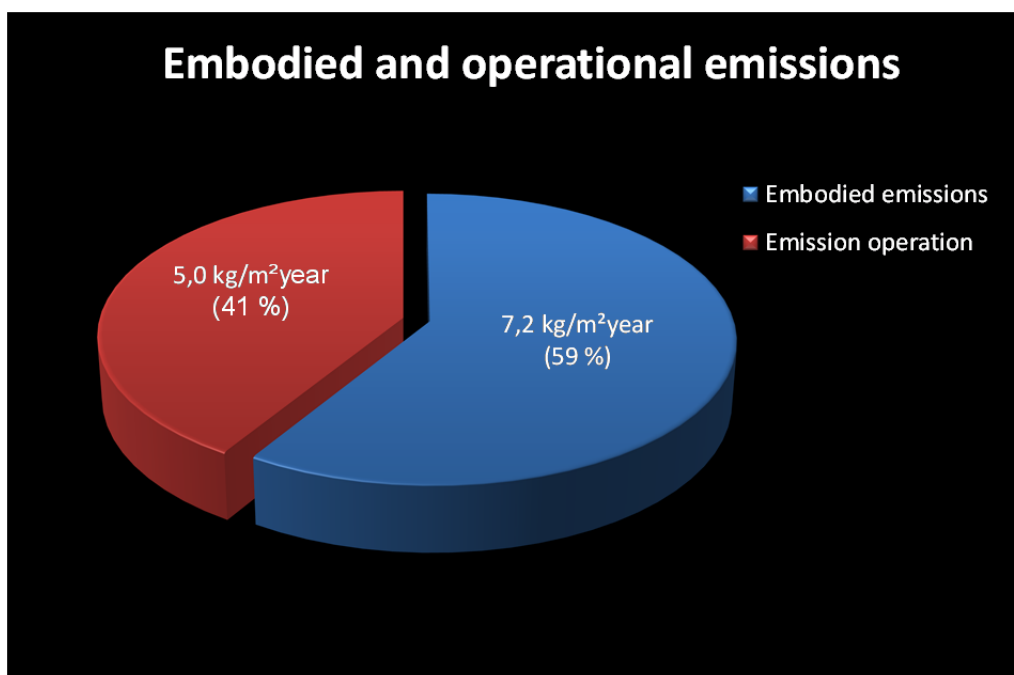

Figure 7.10 The magnitude of embodied and operational emissions for the building.

7.6 Design of on-site electricity production and total CO₂ balance

As calculated in paragraph 7.5 the total CO₂ emission amounts to 1.3 kg CO_{2eq}/m² per year, or 1 964 kg CO_{2eq} per year. With a CO₂ factor of 0.13 kg CO_{2eq}/kWh the necessary PV-production¹⁹ has to be 1 964/0.13 = 15 109 kWh per year. That amounts to 94 kWh per square metre heated floor area per year, which is a very high number to achieve under Norwegian climate conditions.

As calculated in paragraph 5.4 the flat roof mounted PV will have a yearly production of 11 344 kWh. This is equal to 71 kWh per square metre heated floor area per year, which is well above the yearly operational energy (delivered electricity, 39 kWh/m² per year). Thus, this alternative can be called a plus energy house i.e. it produces more energy than it consumes. The PV-production is covering 75 % of the total CO₂ emission, as illustrated in Figure 7.11, and therefore fails to achieve the ZEB-OM target. But it satisfies the ZEB-O level by far, as defined in paragraph 1.5.

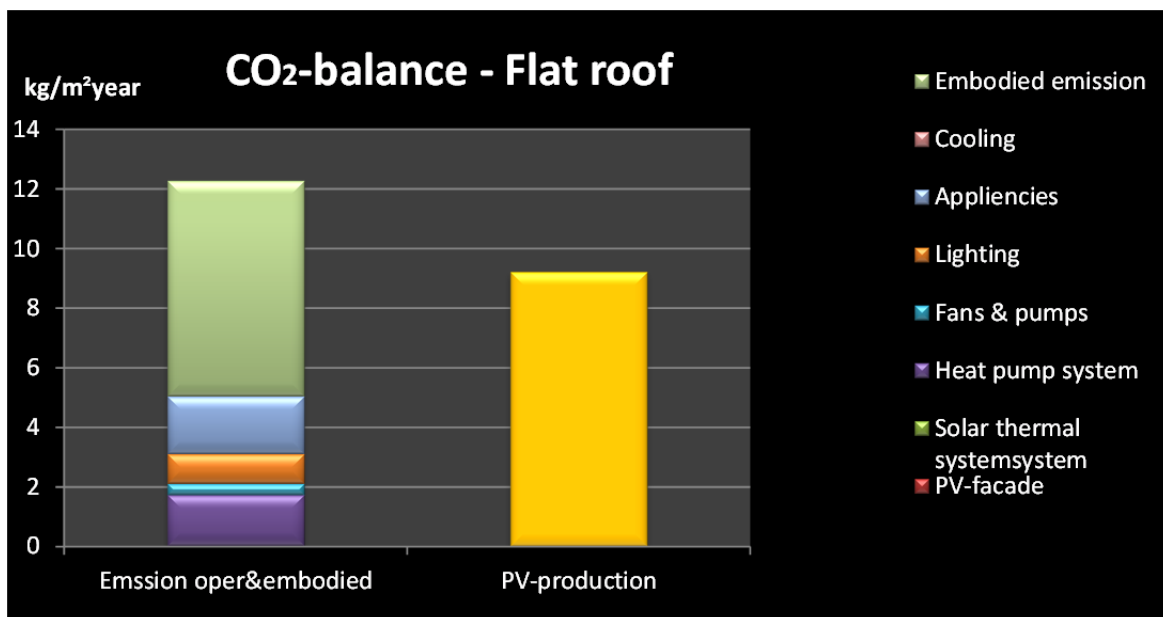

Figure 7.11 CO₂ balance between embodied- and operational emission, and PV-production. With roof mounted PV.

7.7 Mismatch in demand and production

As described in 7.6 the PV production is higher than the energy demand (delivered electricity). Hence, a proportion of the solar electricity produced has to be exported to the grid. In addition, the solar production will be very much larger in summer than winter, contrary to the electricity demand which is larger in winter due to the space heating demand. This adds to the challenge of the mismatch between energy production (PV) and the electricity demand. The mismatch between production and demand is "measured" by two factors:

1. The monthly load mismatch factor (f_{load}), which is a generalisation of the solar fraction calculated for solar thermal systems. It tells how much of the monthly (electric) demand that is covered by the production (PV).

¹⁹ This is based on the assumptions that exported electricity to the grid will offset equivalent amount of electricity in the central el-grid system, produced with the same mean CO₂-emissions as the imported (bought) electricity. I.e. the same CO₂ factor is used for both exported and imported electricity (symmetric CO₂-factor).

2. The monthly exported fraction (X) of the produced energy (PV), which tells how much of the production that has to be exported to the grid.

The production and demand is calculated only with a monthly time resolution, and will therefore not be a realistic measure of the real exported energy and mismatch for such a building. To get a more realistic measure of mismatch, one has to simulate on an hourly basis, but this is beyond the scope of this introductory study. However, the monthly resolution still gives a clear indication of the mismatch between production and demand.

Figure 7.12 shows the mismatch between PV-production and electricity demand. During the eight months period between March to October, the PV-production covers the demand, but rest of the year there needs to be a net import of electricity from the grid. The annual mismatch load factor is $f_{load} = 0.62$, meaning that 62 % of the electric demand is met by PV-production, and 38 % has to be imported from the grid. The export fraction is $X = 0.66$, meaning that 66 % of the PV-production has to be exported to the grid, while 34 % of the production goes to self-consumption.

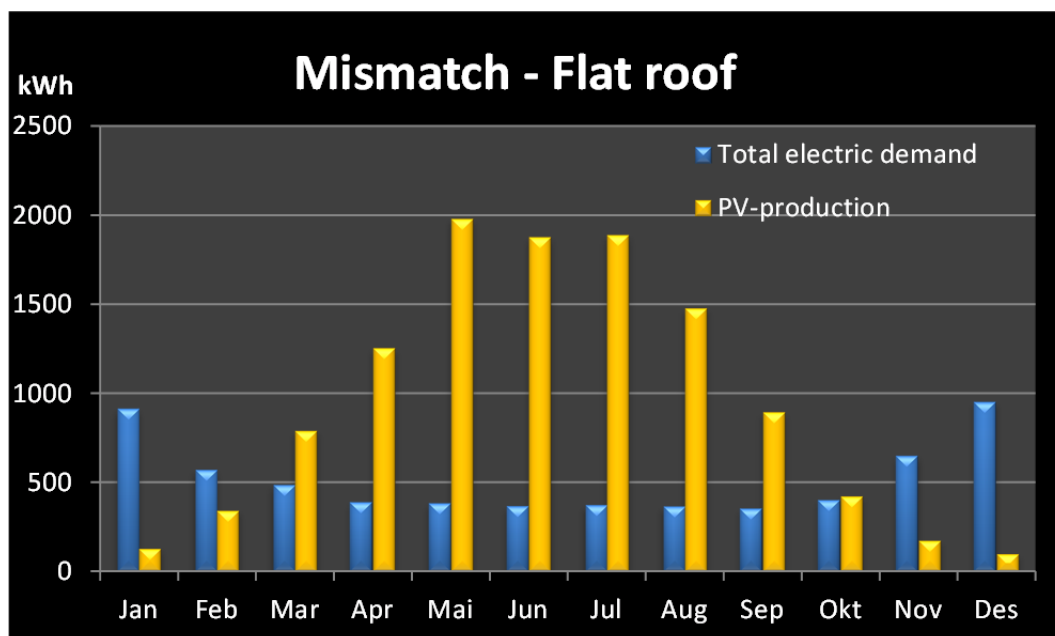

Figure 7.12 Monthly mismatches between PV-production and electric demand. Alternative with PV mounted on a flat roof.

8. Indoor Climate Simulations

The large bedroom on the 2nd floor together with the entire 1st and 2nd floor is selected for simulation of thermal comfort and indoor air quality. Table 8.1 give internal loads and air flow rates used in the simulation of thermal comfort (summer) and indoor air quality (CO₂).

Table 8.1 Internal loads and air flow rates used at design condition for indoor climate simulations.

| Internal load and air flow rate | 1 st floor | 2 nd floor | Large bedroom |
|---|---|--|---|
| Person load | 1.5 W/m ² , continuous occupation | 1.5 W/m ² , continuous occupation | 2 persons ¹ night 8 hours (23-07), 1 person 7 hours (16-23). |
| Lighting load | 1.3 W/m ² , 16 hours of operation | 1.3 W/m ² , 16 hours of operation | 1.3 W/m ² , 16 hours of operation |
| Appliances load | 2.56 W/m ² , 16 hours of operation | 2.56 W/m ² , 16 hours of operation | 2.56 W/m ² , 16 hours of operation |
| Air flow rate at design summer conditions | 1.2 m ³ /hm ² mech.ventilation + 13 m ³ /hm ² (5 ach) natural ventilation | 1.2 m ³ /hm ² mech.ventilation + | 4 m ³ /hm ² , diurnal operation + 6.7 m ³ /hm ² (3 ach) natural ventilation |
| Air flow rate at design winter conditions | 1.2 m ³ /hm ² | 1.2 m ³ /hm ² | 4 m ³ /hm ² , diurnal operation |
| Artificial shading | External blinds against south. | No art.shading. | No art.shading. |
| Natural shading | 9 degree horizon shading and window 100 mm into wall. | 9 degree horizon shading, and window 100 mm into wall. | 9 degree horizon shading, and window 100 mm into wall. |
| Thermal mass | 52 Wh/m ² K | 20 Wh/m ² K | 21 Wh/m ² K |

¹ Assuming 80 W/person, gives 12.3 W/m² during the night, and 2.7 W/m² during the day (07-23).

8.1 Thermal comfort summer

It is assumed that there is a negligible temperature difference between different rooms on each floor. This is a reasonable approximation when cross flow ventilation is applied during a heat wave. However, each floor (1st and 2nd) is assumed to be adiabatically separated, which is a conservative approximation (leading to highest max temperature).

8.1.1 First floor

With a constant diurnal cross flow ventilation of five ach ($13 \text{ m}^3/\text{hm}^2$), adding some night cooling effect, and satisfactory temperature is achieved on the first floor under design summer condition²⁰. Maximum operative temperature is simulated to 24.6 °C.

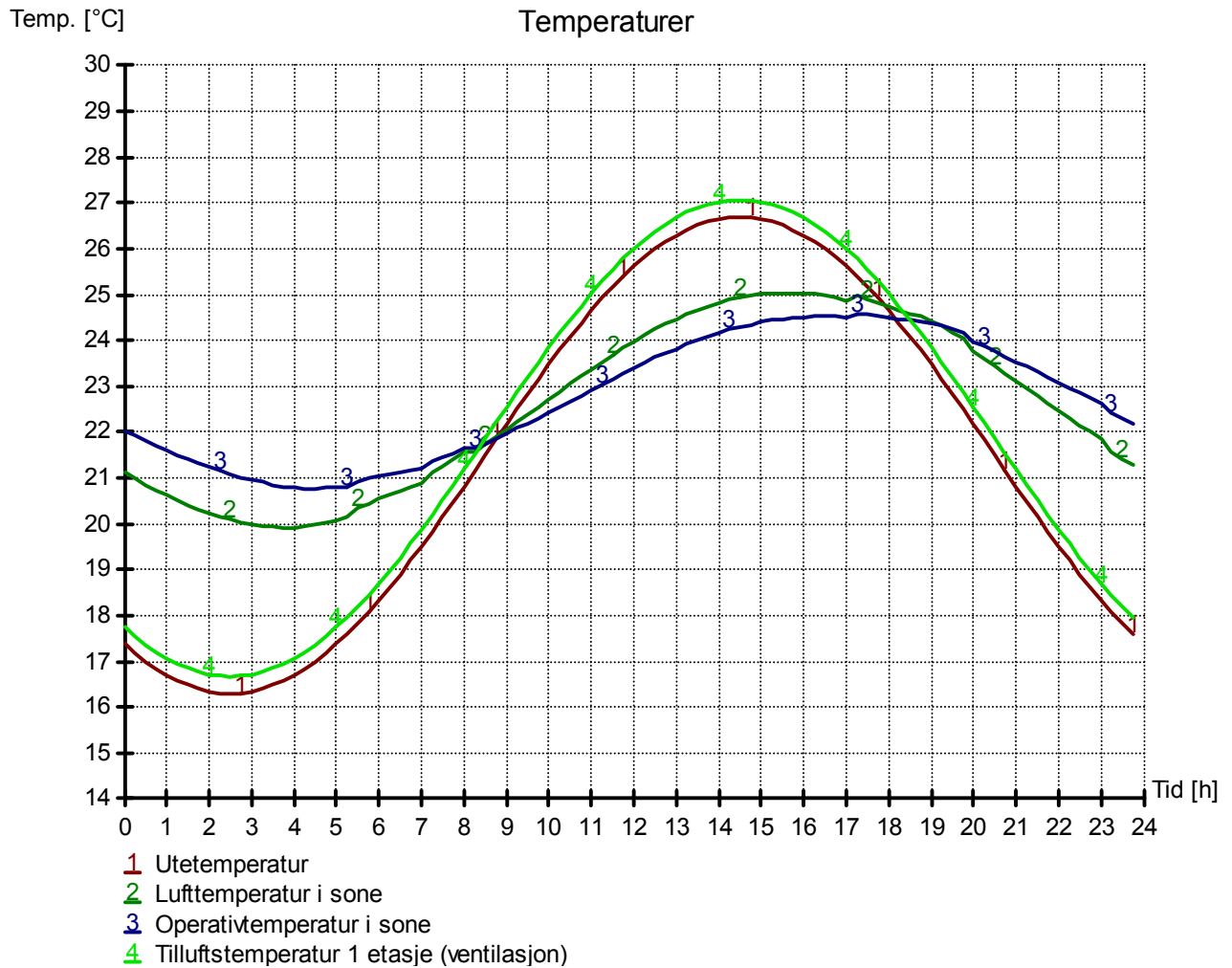

Figure 8.1 Simulated temperatures on the first floor during design summer condition.

²⁰ There exist no Norwegian standard for how thermal summer comfort shall be calculated. Here we have used the external temperature that is exceeded 50 hours in a normal year (26.7 °C for Oslo), and added a typical daily temperature amplitude. This condition is simulated as a heat wave of five days in a row, with clear sky radiation.

8.1.2 Second floor

With a constant diurnal cross flow ventilation of five ach ($13 \text{ m}^3/\text{hm}^2$) the maximum operative temperature in the 2nd floor is simulated to $26.0 \text{ }^\circ\text{C}$, which is regarded as the maximum allowed temperature. Since the thermal mass is small in the 2nd floor has ($20 \text{ Wh}/\text{m}^2\text{K}$), adding some thermal mass would probably improve the thermal comfort. If we add a concrete wall 4 meter long, 2.5 meter high and exposed on both sides, this will increase the thermal mass to $35 \text{ Wh}/\text{m}^2\text{K}$. This increased mass will lower the operative temperature to $25.1 \text{ }^\circ\text{C}$, which can be regarded as a comfortable temperature in summer.

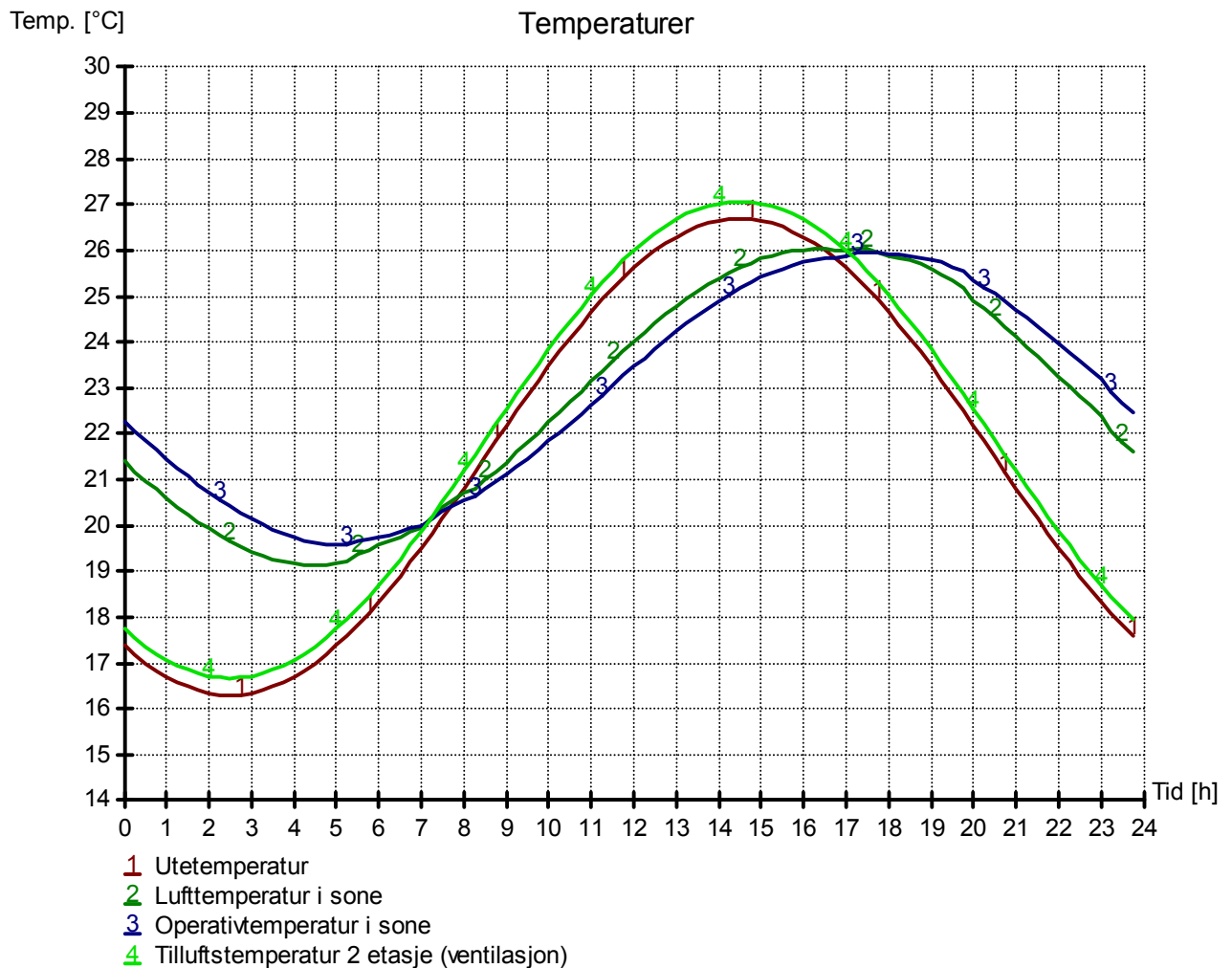

Figure 8.2 Simulated temperatures on the 2nd floor during design summer condition (with "low" thermal mass: $20 \text{ Wh}/\text{m}^2\text{K}$).

8.2 Air quality

8.2.1 First and second floor

During summer when air flow rates are high (assisted by natural ventilation) to achieve good thermal comfort, air quality is generally good with CO₂ levels in the range 450 – 700 PPM. However, the wintertime is more critical when the balanced ventilation is only 1.2 m³/hm². Figure 8.3 shows the CO₂ levels during a day with normal person density of 1.5 W/m² which equals to three people in the house using/demonstrating a normal activity level. The maximum CO₂ level is 630 PPM, which is well below the normal requirement of 1 000 ppm. The level is the same on both floors of the house. This is not surprising, since the average CO₂ level for the whole house is seldom a problem.

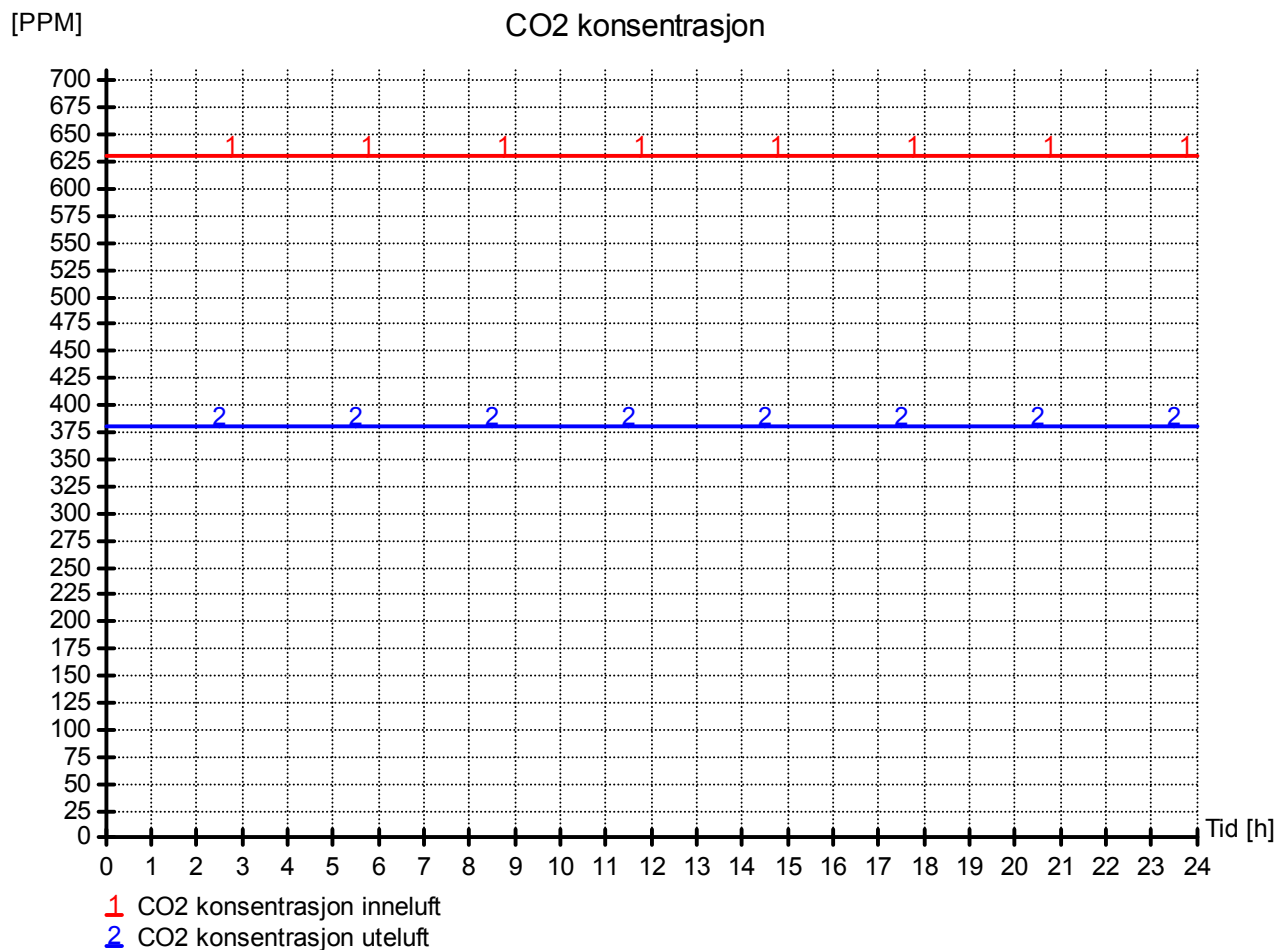

Figure 8.3 Simulated CO₂ level for the first floor during winter condition, with "low" airflow rate (1.2 m³/hm²).

8.2.2 Large bedroom

The requirement for ventilation in bedrooms in the Norwegian building code is 26 m³/h. The airflow rate for the large bedroom is therefore set to 52 m³/h (2 persons, 4 m³/hm²). Figure 8.4 shows the CO₂ levels during design winter conditions (no airing with windows). The maximum CO₂ level is 1010 PPM. This is a satisfactory level when the temperature is close to 20-21 °C.

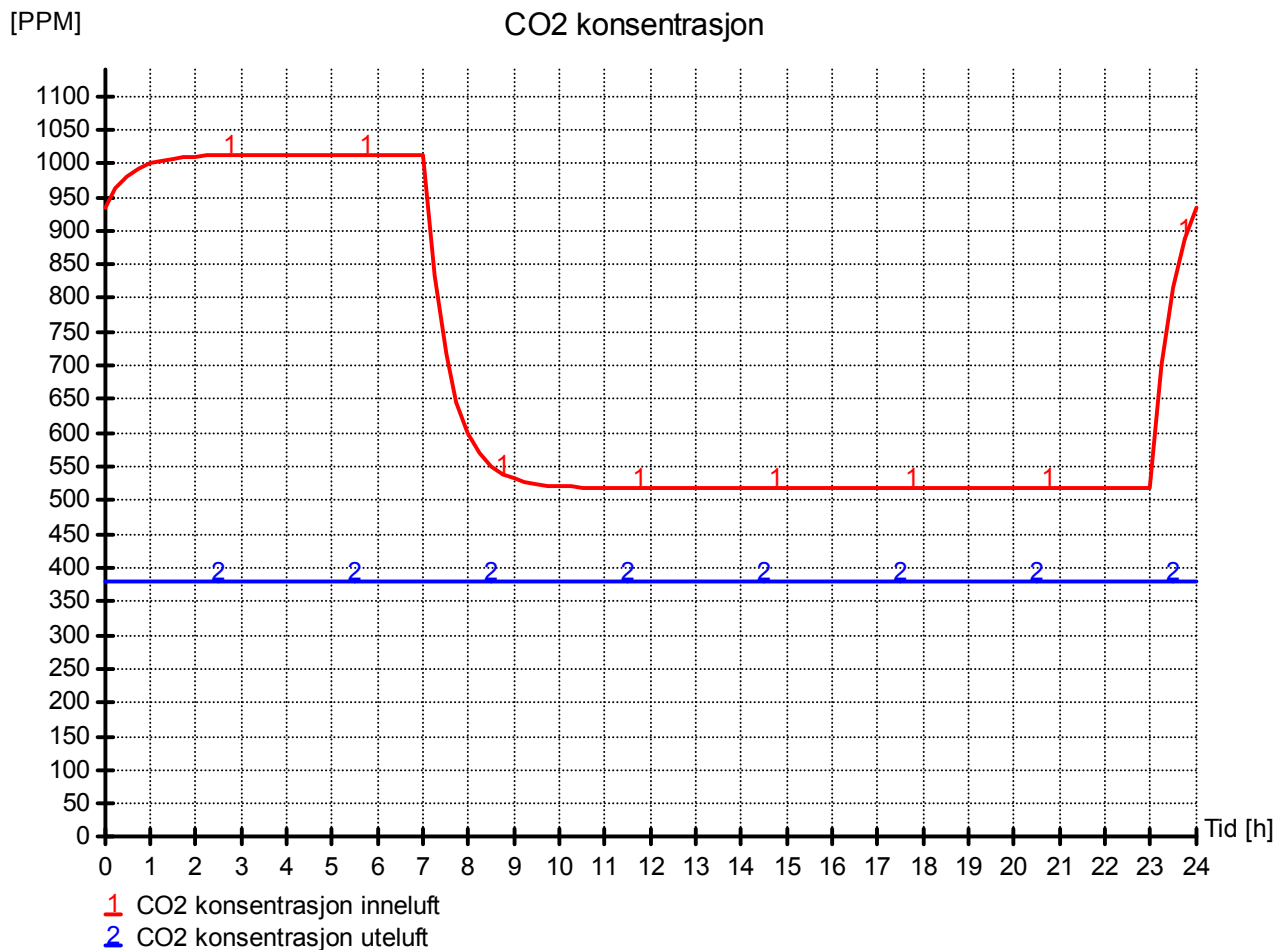

Figure 8.4 Simulated CO₂ level in large bedroom for two persons, during winter condition with "low" airflow rate (4 m³/hm²).

9. Discussion, Preliminary Conclusions and Further Work

9.1 Discussion

The aim of this study was to see if it was possible to achieve an "all-electric" ZEB residential building by balancing operational- and embodied emissions by PV-production on the building. The conventional and obvious way is to use the roof for PV-panels. As calculated in paragraph 7.6 the ZEB-O criteria is easily met, but the PV-productions covers only 77 % of the emissions from operation and materials (ZEB-OM). In addition the single family house (SFH) becomes a "massive" plus energy building with net export to the electric grid 8 months a year, with need of net import only the four winter months (November-February).

To achieve the full ZEB-OM criteria, there are different ways to reach that:

1. Further reducing the (net) energy demand.
2. Using hot fill machines for washing machines, dish washers and dry tumblers, and thereby reducing the electricity demand.
3. Increase the efficiency of the thermal system, by increasing the COP of heat supply system²¹.
4. Reducing the embodied emission.
5. Increase the PV-production.
6. Exploit other on-site electricity producing solutions, like "building integrated" wind generators.

Even if the net energy demand is rather very low, both heating and el-specific energy demand can be reduced further. Super insulated windows with extremely low U-value, very high heat recovery exchangers, ventilation system with extremely low fan power (SFP), and very energy efficient lighting can be measures to reduce the demand further.

By using hot fill machines, the electricity demand is reduced, and the increased thermal demand can be met by high efficiency thermal system (solar, HP), leading to lower delivered electricity need.

Combined and optimized solar, heat pumps (often using the ground as source) with very high annual COP (SPF²²) could reduce the delivered electricity to the thermal system. There are probably a large potential to raise the COP/SPF considerably compared to the values used in this study.

There is probably a large potential to reduce the embodied emission for building materials and installations. No effort has been made to optimize the material used in the building, only conventional materials and solutions have been used. On the other side; more accurate methods, data for materials and material inventories could also lead to raised CO₂ emissions.

There are several ways to increase the solar electricity production from PV-panels. For example optimizing the roof form and orientation so large areas with optimum orientation can be used for PV-panels, or also using part of the south facing facades for PV-production. PV-panels with higher annual efficiency will of course also increase the production.

Other on-site electricity production, like building integrated wind generators can be an interesting solution to increase the total production. But problems like local turbulence, "wind shadows", noise and

²¹ Could also take into account the cooling system, but in this case it has already a high COP for the cooling. An even higher COP will only have a marginal effect on delivered electricity.

²² SFP: Seasonal Performance Factor, can either be calculated/simulated and/or measured.

vibrations have to be solved in a convincing way before building integrated wind can be a real alternative or supplement to PV.

9.2 Preliminary conclusion

The preliminary conclusions from this study are:

1. For a typical single family home (2 storeys) it is rather easy to achieve a ZEB-O²³ level, which in this case²⁴ can be labeled a zero energy building (energy produced on-site with PV equals total electricity demand).
2. Taking into account also the embodied emissions from materials and installations it is difficult to achieve the ZEB-OM (operation and material, see section 1.5) level by using only the flat roof for PV-production.
3. Even if the calculation of embodied emission (EE) has considerable uncertainties, preliminary results indicate that EE is significantly higher than the emission related to operational energy use. However, in current calculation no effort has been made to reduce EE, in contrast to operational energy use where high performance solutions have been used.
4. To achieve a ZEB-OM level a combination of further reduced energy demand, high COP/SPF thermal systems, reduced embodied emissions and increased PV-production seems to be the solution.

This study does not consider other on-site electricity production alternatives like bio-CHP²⁵, or building integrated wind generators. This study is also restricted to analysing operational- and embodied emission, not taking into account emissions related to the construction and demolition phase (see ZEB-COM level, paragraph 1.5)..

9.3 Further work

Based on the analysis in this report, some of the issues that need work that is more detailed are listed below. In some cases, explicit goals for system or component performance are proposed.

- The heating system should be analysed in more detail in order to know how it can be simplified whilst at the same time achieving good comfort in all rooms.
- To analyse what is an optimal level of thermal mass in such a high performance building, taking into account the acoustic environment.
- To analyse how low the energy demand for lighting can be reduced without sacrificing good indoor climate (including lighting conditions) and functionality.
- To analyse how a ventilation system with very low fan power (SFP) and very high heat recovery rate can be designed. **Goal: SFP < 0.5 kW/(m³/s) and $\eta \geq 90$ %.**

²³ Zero Emission Building in operation, see paragraph 1.5 for details.

²⁴ The analyses in this report are restricted to "all electric" buildings, meaning that heating and cooling is provided by heat pump/cooling machines and/or solar system, which "transforms" the thermal demand into (a lower) electric demand. And this electric demand is met by on-site renewables as PV and/or wind generators.

²⁵ Bio-CHP: Combined heat and power units producing both heat and electricity, using some kind of bio-fuel (solid, fluid or gas).

- To analyse how high performance windows with very low U-value, high g-value and high light transmittance can be designed and achieved. **Goal: $U \leq 0.55 \text{ W/m}^2\text{K}$, $g \geq 0.45$, $LT \geq 65 \%$.**
- To analyse how an optimal i.e. combined, solar thermal and geothermal heat pump system should be designed. **Goal: Annual system COP for thermal heat system: $\text{COP}_h > 5.0$**
- Continued work to improve data, methods and material inventories for more accurate embodied emission calculations. Making it possible to make reliable tools which can be used for the optimisation of material use in order to minimise embodied emission. **Goal: Embodied emission $< 5,0 \text{ kg/m}^2\text{a}$.**
- To analyse other solutions for on-site electricity production, like bio-CHP solutions, low-carbon solutions or building integrated or on-site wind generators.
- To analyse and develop methods and tools for taking into account emissions due to the construction and demolition process.

10. References

- \1\ Revit Architecture Suite version 2011.
(<http://www.autodesk.no/adsk/servlet/pc/index?siteID=446819&id=14609041>)
- \2\ SimaPro version 7.3. (http://www.misa.no/software/simapro_lca_verktoey/)
- \3\ EcolInvent version 2.2. (<http://www.ecoinvent.ch/>)
- \4\ SIMIEN 5.11, SIMulation of Indoor climate and ENergy use. www.programbyggerne.no\2\
Revit fra Autodesk: <http://www.autodesk.no/adsk/servlet/pc/index?siteID=446819&id=14609041>
- \5\ Polysun 5.1 Simulation Software. Velasolaris AG. www.velasolaris.com
- \6\ PV-syst 5.62 Photovoltaic System Software. <http://www.pvsyst.com/en/>
- \7\ Uvsløkk, Time, Jelle, "Emerging envelope solutions suitable for ZEBs – optimization of envelopes", Lecture notes for PhD course in ZEB at NTNU, Trondheim October 2012.
- \8\ Byggforskserien 523.701 Innsetting av vindu i vegger av bindingsverk 2012.
- \9\ NS3700:2010 Criteria for passive houses and low energy buildings – Residential buildings. Standard Norway 2010.
- \10\ NS3031:2007 Calculation of energy performance of buildings Method and data.
- \11\ Gustavsen A., Thue J.V., Blom P., Dalehaug A., Aurlen T., Grynning S., Uvsløkk S., "Kuldebroer – Beregning, kuldebroverdier og innvirkning på energibruk" SINTEF Byggforsk Prosjektrapport 25, 2008.
- \12\ NS3451:2009 Bygningsdelstabellen. (Table of building elements).
- \13\ EN15978: Sustainability of construction works. Assessment of environmental performance of buildings. Calculation method.
- \14\ Dokka, TH, 2011. Proposal for CO₂-factor for electricity and outline of a full ZEB-definition, Internal ZEB report
- \15\ Dokka, TH; Sartori, I; Thyolt, M, Lien K; Lindberg KB, 2013. A Norwegian Zero Emission Building Definition. Proceedings from the Passivhus Norden 2013, 15-18 October 2013, Göteborg, Sweden.

APPENDICES

A. Input values energy simulations

Table A.1. Summary of input data for the SIMIEN simulation.

| Description | Value |
|--|-------|
| Area external wall [m ²]: | 140 |
| Area roof [m ²]: | 80 |
| Area floor [m ²]: | 80 |
| Area windows and doors m ² : | 36 |
| Heated floor area (BRA) [m ²]: | 160 |
| Heated air volume [m ³]: | 420 |
| U-value external wall [W/m ² K] | 0,12 |
| U-value roof [W/m ² K] | 0,10 |
| U-value floor [W/m ² K] | 0,06 |
| U-value windows and doors [W/m ² K] | 0,65 |
| Area windows and doors divided by heated floor area [%] | 22,5 |
| Normalized thermal bridge value [W/m ² K]: | 0,03 |
| Normalized heat capacity [Wh/m ² K] | 38 |
| Air leakage (n50) [1/h]: | 0,30 |
| Temperature efficiency heat exchanger [%]: | 88 |
| Estimated efficiency exchanger adjusted for frost prevention [%]: | 88.0 |
| Specific fan power (SFP) [kW/m ³ /s]: | 1.00 |
| Air flow rate in operating hours [m ³ /hm ²], heating season | 1.2 |
| Air flow rate outside operating hours [m ³ /hm ²], heating season | 1.2 |
| Air flow rate in operating hours [m ³ /hm ²], cooling season | 1.2 |
| Air flow rate outside operating hours [m ³ /hm ²], cooling season | 1.2 |
| System efficiency heating system: | 3.8 |
| Installed power capacity room heating and heating coil. [W/m ²]: | 18 |
| Set point temperature heating, operating hours [°C] | 21.0 |
| Set point temperature heating, outside operating hours [°C] | 19.0 |
| Specific pump power heating [kW/(l/s)]: | 0.30 |
| Operating hours ventilation (hours) | 24 |
| Operating hours lighting (hours) | 16 |
| Operating hours equipment (hours) | 16 |
| Occupation hours persons ((hours) | 24 |
| Power demand and heat load lighting in operating hours [W/m ²] | 1.3 |
| Power demand and heat load equipment in operating hours [W/m ²] | 2.56 |
| Average power demand DHW on operating days [W/m ²] | 2.72 |
| Heat load persons in operating hours [W/m ²] | 1.5 |
| Total solar shading factor window and artificial shading: | 0.40 |
| Average frame factor windows: | 0.20 |
| Shading factor horizon and building extensions: | 0.73 |

B. Details from Polysun simulations

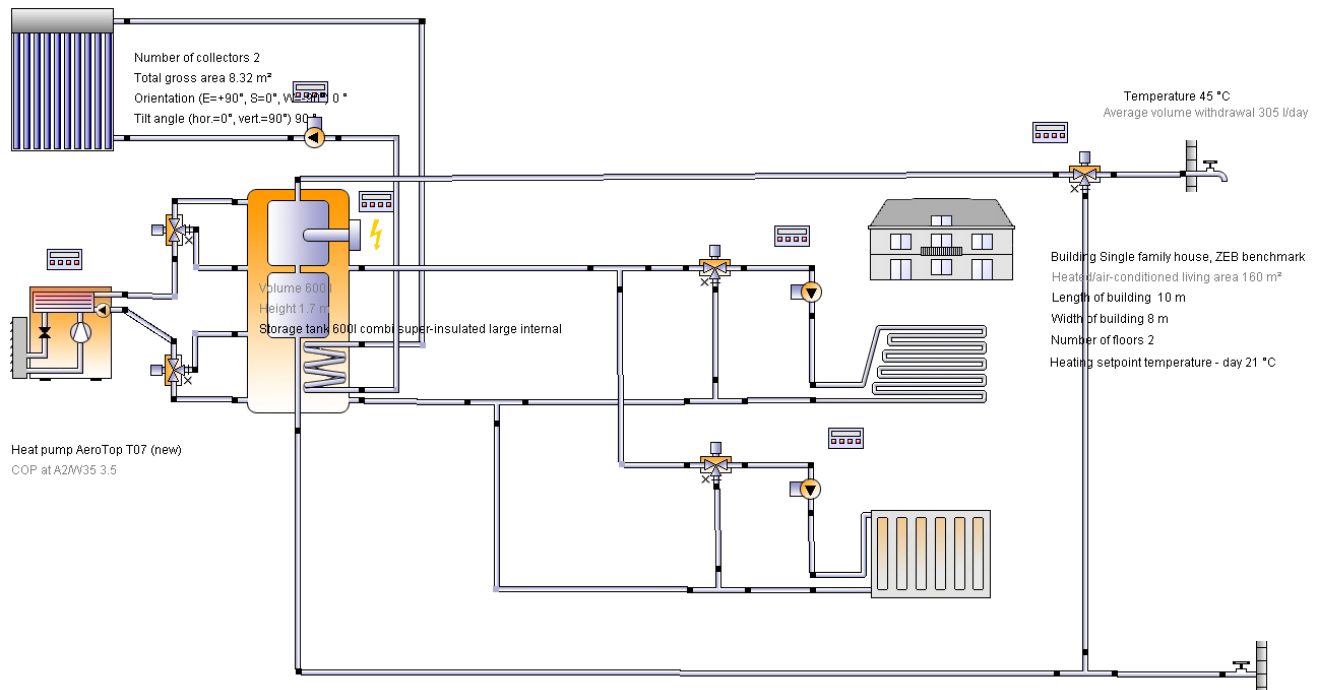

Figure B.1 System schematic of the simulation model in Polysun.

Overview solar thermal energy (annual values)

| | |
|---|--------------------------------|
| Collector area | 8.3 m ² |
| Solar fraction total | 41.6% |
| Solar fraction hot water [SFnHw] | 57.9 % |
| Solar fraction building [SFnBd] | 13.7 % |
| Total annual field yield | 3,373.6 kWh |
| Collector field yield relating to gross area | 405.7 kWh/m ² /Year |
| Collector field yield relating to aperture area | 564.1 kWh/m ² /Year |
| Max. energy savings | 3,382.1 kWh |
| Max. reduction in CO ₂ emissions | 1,814.2 kg |

Overview heat pump (annual values)

| | |
|---|-------------|
| Seasonal performance factor for air-to-water heat pump | 2.3 |
| Total electrical energy consumption when heating [Eaux] | 2,019.4 kWh |
| Total energy savings | 2,642.9 kWh |
| Total reduction in CO ₂ emissions | 1,417.6 kg |

Figure B.2 Excerpt from the results from the Polysun simulation.

| | Year | Jan | Feb | Mar | Apr | May | Jun | Jul | Aug | Sep | Oct | Nov | Dec |
|---|------|------|-----|------|------|------|------|------|------|------|------|------|------|
| Solar thermal energy to the system [Qsol] | | | | | | | | | | | | | |
| kWh | 3374 | 159 | 280 | 352 | 310 | 363 | 336 | 341 | 346 | 351 | 272 | 170 | 95 |
| Heat generator energy to the system (solar thermal energy not included) [Qaux] | | | | | | | | | | | | | |
| kWh | 4745 | 1199 | 544 | 304 | 135 | 92 | 86 | 76 | 58 | 47 | 139 | 743 | 1322 |
| Heat generator fuel and electrical energy consumption [Eaux] | | | | | | | | | | | | | |
| kWh | 2107 | 562 | 255 | 139 | 53 | 37 | 32 | 26 | 19 | 17 | 55 | 311 | 601 |
| Solar fraction: fraction of solar energy to system [SFn] | | | | | | | | | | | | | |
| % | 41.6 | 11.7 | 34 | 53.6 | 69.7 | 79.7 | 79.5 | 81.8 | 85.7 | 88.2 | 66.1 | 18.7 | 6.7 |
| Total fuel and/or electrical energy consumption of the system [Etot] | | | | | | | | | | | | | |
| kWh | 2138 | 568 | 259 | 141 | 54 | 38 | 33 | 27 | 20 | 18 | 56 | 316 | 607 |
| Irradiation onto collector area [Esol] | | | | | | | | | | | | | |
| kWh | 7975 | 350 | 603 | 859 | 765 | 870 | 816 | 825 | 859 | 810 | 625 | 366 | 227 |
| Electrical energy consumption of pumps [Epar] | | | | | | | | | | | | | |
| kWh | 31 | 6 | 4 | 2 | 1 | 1 | 1 | 1 | 1 | 1 | 1 | 5 | 6 |
| Heat loss to indoor room (including heat generator losses) [Qint] | | | | | | | | | | | | | |
| kWh | 1059 | 67 | 68 | 94 | 94 | 101 | 100 | 103 | 109 | 102 | 92 | 65 | 64 |
| Heat loss to surroundings (without collector losses) [Qext] | | | | | | | | | | | | | |
| kWh | 43 | 2 | 3 | 4 | 4 | 5 | 4 | 4 | 4 | 4 | 4 | 2 | 1 |
| Total energy consumption [Quse] | | | | | | | | | | | | | |
| kWh | 7056 | 1292 | 760 | 555 | 347 | 346 | 317 | 310 | 297 | 284 | 335 | 855 | 1359 |

Figure B.3 Excerpt from the results from the Polysun simulation.

C Results PV-syst simulation

South facing PV

| | | | | |
|--|---------------------------------------|---------------------------|--------------------------------|------------------------------|
| PVSYST V5.56 | Sintef Building and Infrastructure | | 20/11/12 | Page 1/4 |
| ZEB WP5 concept - single family house | | | | |
| Grid-Connected System: Simulation parameters | | | | |
| Project : | Grid-Connected Project at Oslo | | | |
| Geographical Site | Oslo | Country | Norway | |
| Situation | Latitude | 59.5°N | Longitude | 10.4°E |
| Time defined as | Legal Time | Time zone UT+1 | Altitude | 5 m |
| | Albedo | 0.20 | | |
| Meteo data : | Oslo, Synthetic Hourly data | | | |
| Simulation variant : | 3 rows - south | | | |
| | Simulation date | 20/11/12 11h55 | | |
| Simulation parameters | | | | |
| Collector Plane Orientation | Tilt | 10° | Azimuth | 0° |
| Horizon | Free Horizon | | | |
| Near Shadings | Linear shadings | | | |
| PV Array Characteristics | | | | |
| PV module | Si-mono | Model | SPR-333NE-WHT-D | |
| | | Manufacturer | SunPower | |
| Number of PV modules | In series | 5 modules | In parallel | 6 strings |
| Total number of PV modules | Nb. modules | 30 | Unit Nom. Power | 333 Wp |
| Array global power | Nominal (STC) | 9.99 kWp | At operating cond. | 9.02 kWp (50°C) |
| Array operating characteristics (50°C) | U mpp | 244 V | I mpp | 37 A |
| Total area | Module area | 48.9 m² | Cell area | 44.2 m ² |
| Inverter | | | | |
| | | Model | Sunny Boy SB 3800 U-208 | |
| | | Manufacturer | SMA | |
| Characteristics | Operating Voltage | 218-480 V | Unit Nom. Power | 3.30 kW AC |
| Inverter pack | Number of Inverter | 3 units | Total Power | 9.90 kW AC |
| PV Array loss factors | | | | |
| Thermal Loss factor | Uc (const) | 20.0 W/m ² K | Uv (wind) | 0.0 W/m ² K / m/s |
| => Nominal Oper. Coll. Temp. (G=800 W/m ² , Tamb=20°C, Wind=1 m/s.) | | | NOCT | 56 °C |
| Wiring Ohmic Loss | Global array res. | 111 mOhm | Loss Fraction | 1.5 % at STC |
| Module Quality Loss | | | Loss Fraction | 2.5 % |
| Module Mismatch Losses | | | Loss Fraction | 2.0 % at MPP |
| Incidence effect, ASHRAE parametrization | IAM = | 1 - bo (1/cos i - 1) | bo Parameter | 0.05 |
| User's needs : | Unlimited load (grid) | | | |

ZEB WP5 concept - single family house

Grid-Connected System: Near shading definition

Project : Grid-Connected Project at Oslo

Simulation variant : 3 rows - south

| | | | | |
|-------------------------------|-----------------------|------------------------------|------------|-------------------|
| Main system parameters | System type | Grid-Connected | | |
| Near Shadings | Linear shadings | | | |
| PV Field Orientation | tilt | 10° | azimuth | 0° |
| PV modules | Model | SPR-333NE-WHT-D | Pnom | 333 Wp |
| PV Array | Nb. of modules | 30 | Pnom total | 9.99 kWp |
| Inverter | Model | Sunny Boy SB 3800 U-208 Pnom | | 3300 W ac |
| Inverter pack | Nb. of units | 3.0 | Pnom total | 9.90 kW ac |
| User's needs | Unlimited load (grid) | | | |

Perspective of the PV-field and surrounding shading scene

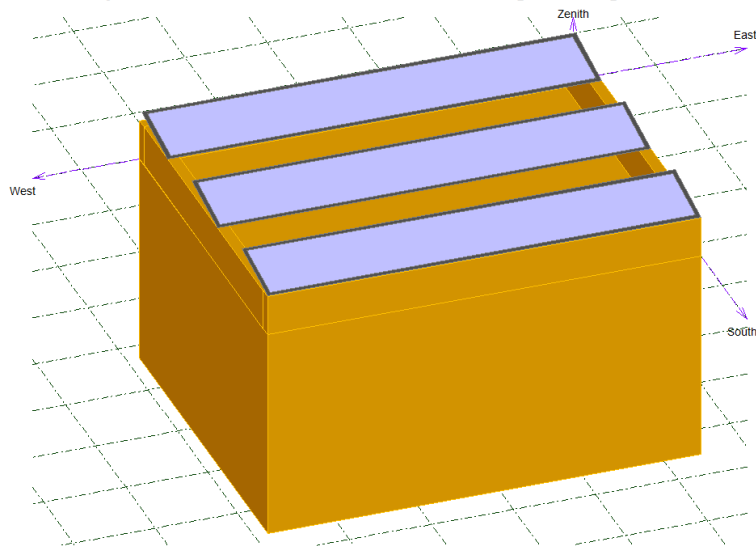

Iso-shadings diagram

Grid-Connected Project at Oslo: Option1 - 10deg 3 rows

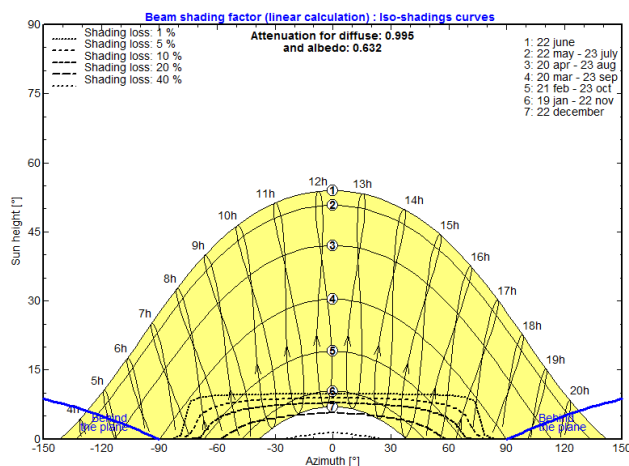

ZEB WP5 concept - single family house

Grid-Connected System: Main results

Project : Grid-Connected Project at Oslo
Simulation variant : 3 rows - south

| | | |
|-------------------------------|------------------------------------|------------------------------|
| Main system parameters | System type Grid-Connected | |
| Near Shadings | Linear shadings | |
| PV Field Orientation | tilt 10° | azimuth 0° |
| PV modules | Model SPR-333NE-WHT-D | Pnom 333 Wp |
| PV Array | Nb. of modules 30 | Pnom total 9.99 kWp |
| Inverter | Model Sunny Boy SB 3800 U-208 Pnom | 3300 W ac |
| Inverter pack | Nb. of units 3.0 | Pnom total 9.90 kW ac |
| User's needs | Unlimited load (grid) | |

Main simulation results
 System Production **Produced Energy 8730 kWh/year** Specific prod. 874 kWh/kWp/year
 Performance Ratio PR **81.3 %**

Normalized productions (per installed kWp): Nominal power 9.99 kWp

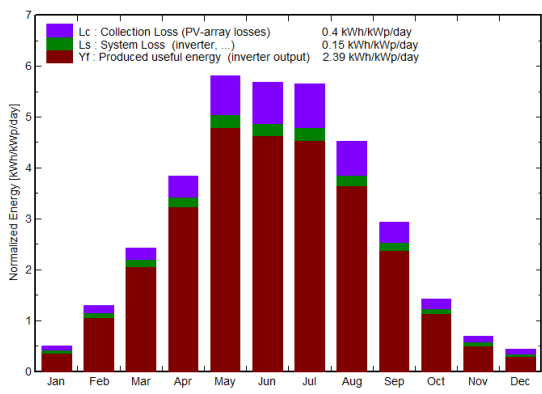

Performance Ratio PR

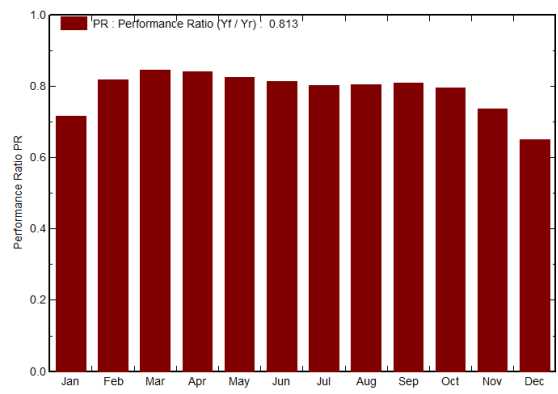

3 rows - south
Balances and main results

| | GlobHor kWh/m ² | T Amb °C | GlobInc kWh/m ² | GlobEff kWh/m ² | EArray kWh | E_Grid kWh | EffArrR % | EffSysR % |
|------------------|-------------------------------|-------------|-------------------------------|-------------------------------|---------------|---------------|--------------|--------------|
| January | 11.0 | -1.70 | 15.4 | 13.7 | 130 | 111 | 17.27 | 14.66 |
| February | 28.0 | -2.40 | 36.1 | 33.4 | 323 | 295 | 18.31 | 16.71 |
| March | 66.0 | 0.30 | 75.4 | 71.3 | 681 | 637 | 18.45 | 17.28 |
| April | 106.0 | 4.70 | 115.3 | 110.0 | 1026 | 970 | 18.19 | 17.19 |
| May | 172.0 | 10.10 | 180.0 | 172.7 | 1561 | 1486 | 17.73 | 16.87 |
| June | 166.0 | 13.90 | 170.6 | 163.8 | 1462 | 1388 | 17.51 | 16.63 |
| July | 169.0 | 17.00 | 175.4 | 168.5 | 1483 | 1408 | 17.28 | 16.41 |
| August | 131.0 | 16.20 | 140.3 | 134.3 | 1193 | 1130 | 17.37 | 16.45 |
| September | 78.0 | 13.20 | 88.2 | 83.8 | 761 | 714 | 17.63 | 16.55 |
| October | 37.0 | 8.70 | 44.0 | 41.3 | 384 | 350 | 17.83 | 16.25 |
| November | 15.0 | 3.70 | 20.6 | 18.6 | 174 | 152 | 17.25 | 15.03 |
| December | 8.0 | 0.80 | 13.8 | 11.3 | 106 | 90 | 15.71 | 13.29 |
| Year | 987.0 | 7.10 | 1075.3 | 1022.7 | 9285 | 8730 | 17.65 | 16.59 |

Legends: GlobHor Horizontal global irradiation EArray Effective energy at the output of the array
 T Amb Ambient Temperature E_Grid Energy injected into grid
 GlobInc Global incident in coll. plane EffArrR Effic. Eout array / rough area
 GlobEff Effective Global, corr. for IAM and shadings EffSysR Effic. Eout system / rough area

ZEB WP5 concept - single family house

Grid-Connected System: Loss diagram

Project : Grid-Connected Project at Oslo
Simulation variant : 3 rows - south

| | | | | |
|-------------------------------|-----------------------|-------------------------|------------|-------------------|
| Main system parameters | System type | Grid-Connected | | |
| Near Shadings | Linear shadings | | | |
| PV Field Orientation | tilt | 10° | azimuth | 0° |
| PV modules | Model | SPR-333NE-WHT-D | Pnom | 333 Wp |
| PV Array | Nb. of modules | 30 | Pnom total | 9.99 kWp |
| Inverter | Model | Sunny Boy SB 3800 U-208 | Pnom | 3300 W ac |
| Inverter pack | Nb. of units | 3.0 | Pnom total | 9.90 kW ac |
| User's needs | Unlimited load (grid) | | | |

Loss diagram over the whole year

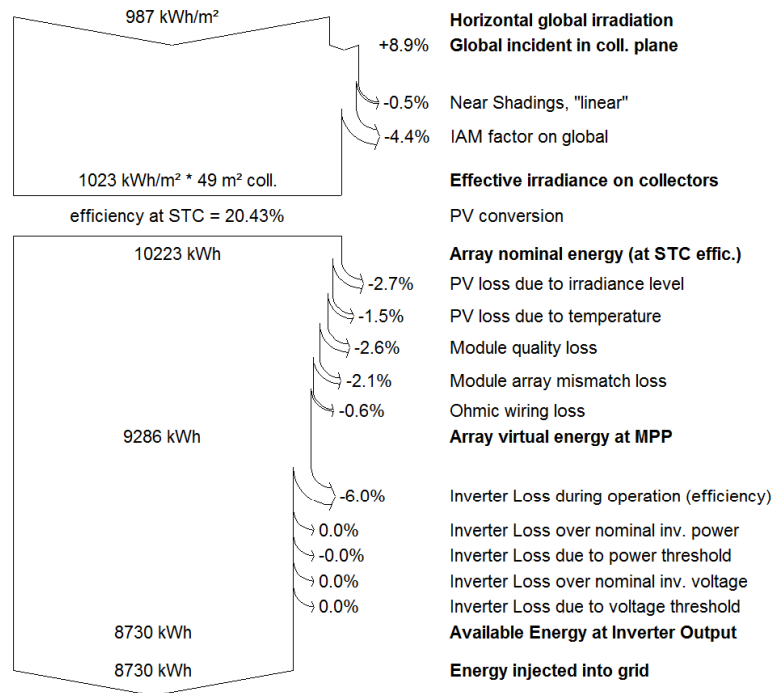

North facing rows

| | | | | |
|---|---------------------------------------|----------------------|----------------------------|-----------------|
| PVSYST V5.56 | Sintef Building and Infrastructure | | 20/11/12 | Page 1/4 |
| ZEB WP5 concept - single family house | | | | |
| Grid-Connected System: Simulation parameters | | | | |
| Project : | Grid-Connected Project at Oslo | | | |
| Geographical Site | Oslo | Country | Norway | |
| Situation | Latitude | 59.5°N | Longitude | 10.4°E |
| Time defined as | Legal Time | Time zone UT+1 | Altitude | 5 m |
| | Albedo | 0.20 | | |
| Meteo data : | Oslo, Synthetic Hourly data | | | |
| Simulation variant : | 2 rows - north | | | |
| | Simulation date | 20/11/12 12h10 | | |
| Simulation parameters | | | | |
| Collector Plane Orientation | Tilt | 15° | Azimuth | 180° |
| Horizon | Free Horizon | | | |
| Near Shadings | Linear shadings | | | |
| PV Array Characteristics | | | | |
| PV module | Si-mono | Model | SPR-333NE-WHT-D | |
| | | Manufacturer | SunPower | |
| Number of PV modules | | In series | In parallel | 2 strings |
| Total number of PV modules | | Nb. modules | Unit Nom. Power | 333 Wp |
| Array global power | | Nominal (STC) | At operating cond. | 3607 Wp (50°C) |
| Array operating characteristics (50°C) | | U mpp | I mpp | 12 A |
| Total area | | Module area | Cell area | 17.7 m² |
| | | 19.6 m² | | |
| Inverter | | | | |
| | | Model | Sunny Boy SWR 2100U | |
| | | Manufacturer | SMA | |
| Characteristics | | Operating Voltage | Unit Nom. Power | 1.90 kW AC |
| Inverter pack | | Number of Inverter | Total Power | 3.80 kW AC |
| | | 2 units | | |
| PV Array loss factors | | | | |
| Thermal Loss factor | Uc (const) | 20.0 W/m²K | Uv (wind) | 0.0 W/m²K / m/s |
| => Nominal Oper. Coll. Temp. (G=800 W/m², Tamb=20°C, Wind=1 m/s.) | | | NOCT | 56 °C |
| Wiring Ohmic Loss | Global array res. | 399 mOhm | Loss Fraction | 1.5 % at STC |
| Module Quality Loss | | | Loss Fraction | 2.5 % |
| Module Mismatch Losses | | | Loss Fraction | 2.0 % at MPP |
| Incidence effect, ASHRAE parametrization | IAM = | 1 - bo (1/cos i - 1) | bo Parameter | 0.05 |
| User's needs : | Unlimited load (grid) | | | |

ZEB WP5 concept - single family house

Grid-Connected System: Near shading definition

Project : Grid-Connected Project at Oslo

Simulation variant : 2 rows - north

| | | | | |
|-------------------------------|-----------------------|-----------------------|------------|------------------|
| Main system parameters | System type | Grid-Connected | | |
| Near Shadings | Linear shadings | | | |
| PV Field Orientation | tilt | 15° | azimuth | 180° |
| PV modules | Model | SPR-333NE-WHT-D | Pnom | 333 Wp |
| PV Array | Nb. of modules | 12 | Pnom total | 3996 Wp |
| Inverter | Model | Sunny Boy SWR 2100U | Pnom | 1900 W ac |
| Inverter pack | Nb. of units | 2.0 | Pnom total | 3800 W ac |
| User's needs | Unlimited load (grid) | | | |

Perspective of the PV-field and surrounding shading scene

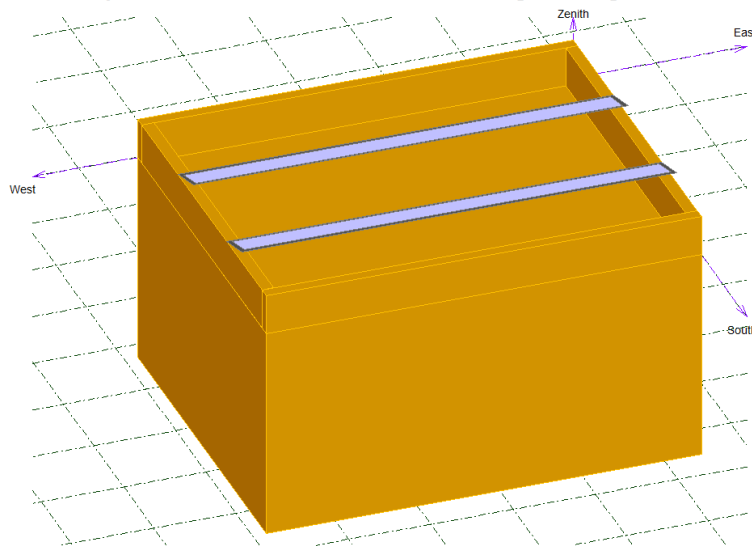

Iso-shadings diagram

Grid-Connected Project at Oslo: Option1 - 15deg 2 rows

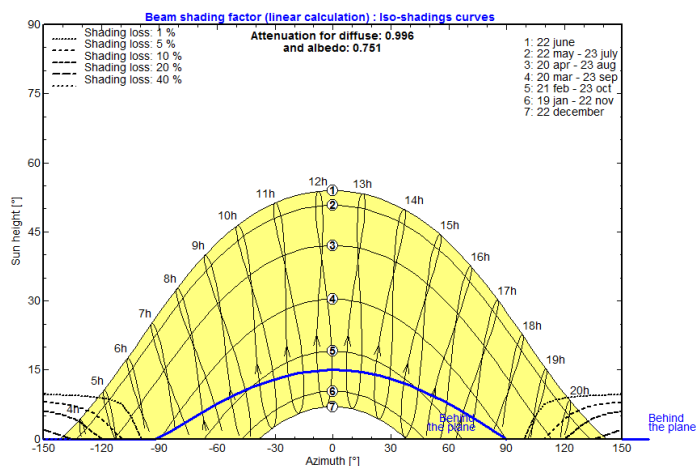

ZEB WP5 concept - single family house

Grid-Connected System: Main results

Project : Grid-Connected Project at Oslo
Simulation variant : 2 rows - north

| | | | | |
|-------------------------------|-----------------------|-----------------------|------------|------------------|
| Main system parameters | System type | Grid-Connected | | |
| Near Shadings | Linear shadings | | | |
| PV Field Orientation | tilt | 15° | azimuth | 180° |
| PV modules | Model | SPR-333NE-WHT-D | Pnom | 333 Wp |
| PV Array | Nb. of modules | 12 | Pnom total | 3996 Wp |
| Inverter | Model | Sunny Boy SWR 2100U | Pnom | 1900 W ac |
| Inverter pack | Nb. of units | 2.0 | Pnom total | 3800 W ac |
| User's needs | Unlimited load (grid) | | | |

Main simulation results
System Production **Produced Energy 2608 kWh/year** Specific prod. 653 kWh/kWp/year
Performance Ratio PR **78.6 %**

Normalized productions (per installed kWp): Nominal power 3996 Wp

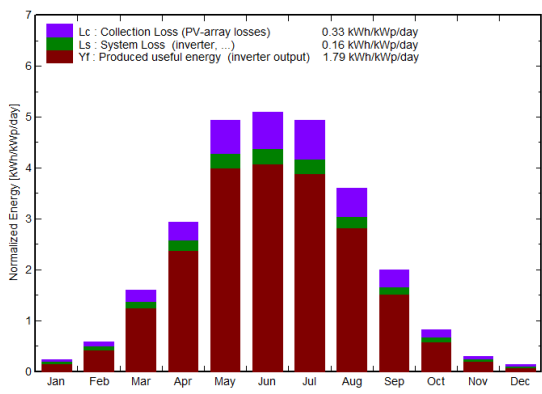

Performance Ratio PR

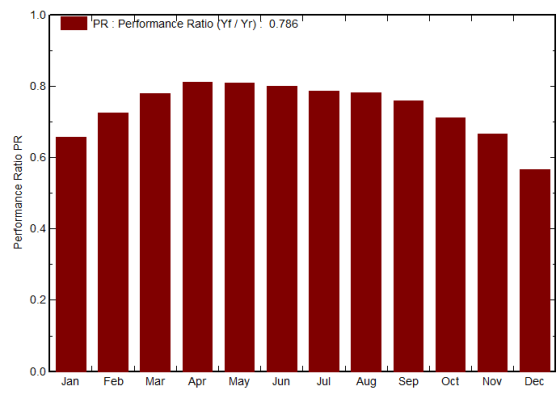

2 rows - north
Balances and main results

| | GlobHor kWh/m² | T Amb °C | GlobInc kWh/m² | GlobEff kWh/m² | EArray kWh | E_Grid kWh | EffArrR % | EffSysR % |
|------------------|-------------------|-------------|-------------------|-------------------|---------------|---------------|--------------|--------------|
| January | 11.0 | -1.70 | 7.1 | 6.8 | 24.5 | 18.7 | 17.55 | 13.42 |
| February | 28.0 | -2.40 | 16.4 | 14.8 | 56.3 | 47.6 | 17.54 | 14.82 |
| March | 66.0 | 0.30 | 49.5 | 44.7 | 170.8 | 154.7 | 16.62 | 15.95 |
| April | 106.0 | 4.70 | 88.0 | 81.9 | 309.4 | 285.4 | 17.96 | 16.57 |
| May | 172.0 | 10.10 | 153.2 | 144.5 | 531.6 | 495.1 | 17.73 | 16.51 |
| June | 166.0 | 13.90 | 152.8 | 145.1 | 525.3 | 488.5 | 17.56 | 16.33 |
| July | 169.0 | 17.00 | 152.9 | 144.9 | 517.6 | 481.3 | 17.31 | 16.09 |
| August | 131.0 | 16.20 | 111.9 | 104.8 | 377.7 | 349.4 | 17.25 | 15.96 |
| September | 78.0 | 13.20 | 59.9 | 54.7 | 199.7 | 181.7 | 17.05 | 15.51 |
| October | 37.0 | 8.70 | 25.6 | 22.9 | 83.9 | 72.7 | 16.76 | 14.52 |
| November | 15.0 | 3.70 | 8.8 | 8.3 | 29.8 | 23.3 | 17.35 | 13.60 |
| December | 8.0 | 0.80 | 4.3 | 4.1 | 13.9 | 9.7 | 16.62 | 11.57 |
| Year | 987.0 | 7.10 | 830.4 | 777.4 | 2840.3 | 2608.1 | 17.48 | 16.05 |

Legends: GlobHor Horizontal global irradiation EArray Effective energy at the output of the array
 T Amb Ambient Temperature E_Grid Energy injected into grid
 GlobInc Global incident in coll. plane EffArrR Effic. Eout array / rough area
 GlobEff Effective Global, corr. for IAM and shadings EffSysR Effic. Eout system / rough area

ZEB WP5 concept - single family house

Grid-Connected System: Loss diagram

Project : Grid-Connected Project at Oslo
Simulation variant : 2 rows - north

| | | | | |
|-------------------------------|-----------------------|-----------------------|------------|------------------|
| Main system parameters | System type | Grid-Connected | | |
| Near Shadings | Linear shadings | | | |
| PV Field Orientation | tilt | 15° | azimuth | 180° |
| PV modules | Model | SPR-333NE-WHT-D | Pnom | 333 Wp |
| PV Array | Nb. of modules | 12 | Pnom total | 3996 Wp |
| Inverter | Model | Sunny Boy SWR 2100U | Pnom | 1900 W ac |
| Inverter pack | Nb. of units | 2.0 | Pnom total | 3800 W ac |
| User's needs | Unlimited load (grid) | | | |

Loss diagram over the whole year

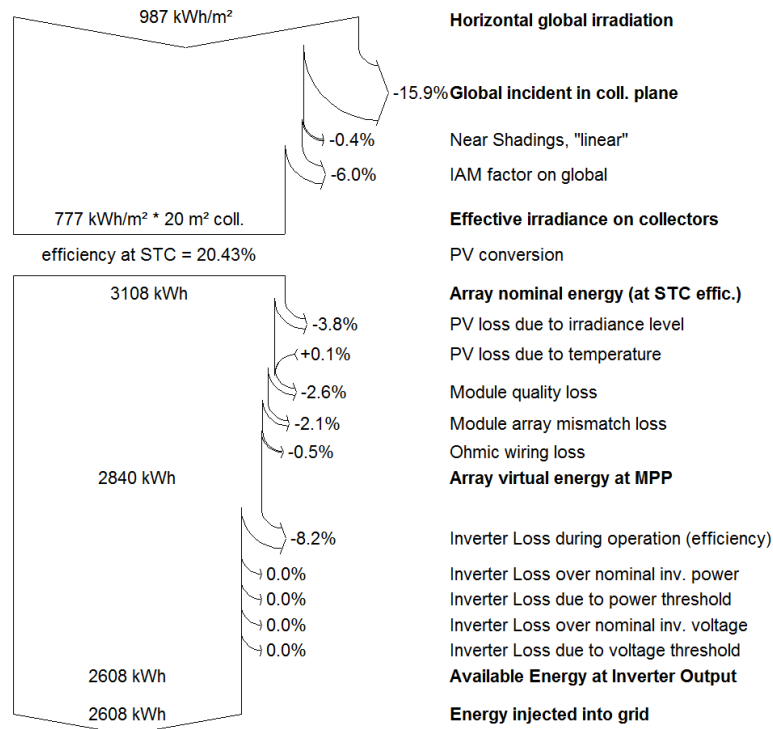

APPENDIX D: DETAILED HEATING SYSTEM ANALYZIS

The heating system analysed is an air-to-water heat pump coupled to solar thermal panels. The space-heating is delivered to the building using two types of heat emitters. First, a floor heating of 750W is applied in the house entrance, the laundry as well as the bathroom. Second, two low temperature radiators with a total of 2 650 W heat the first and second floor, respectively. The layout of the space-heating distribution and emission sub-systems can be found in Figure 1.1. Furthermore, the impact of a grey-water heat recovery system is also investigated. In practice, the building and heating system simulations are performed using the software Polysun 5.10.9. Given the imposed modeling assumption of Polysun, it is assumed that the heat generation systems are located outside the protected volume of the building (see next explanations).

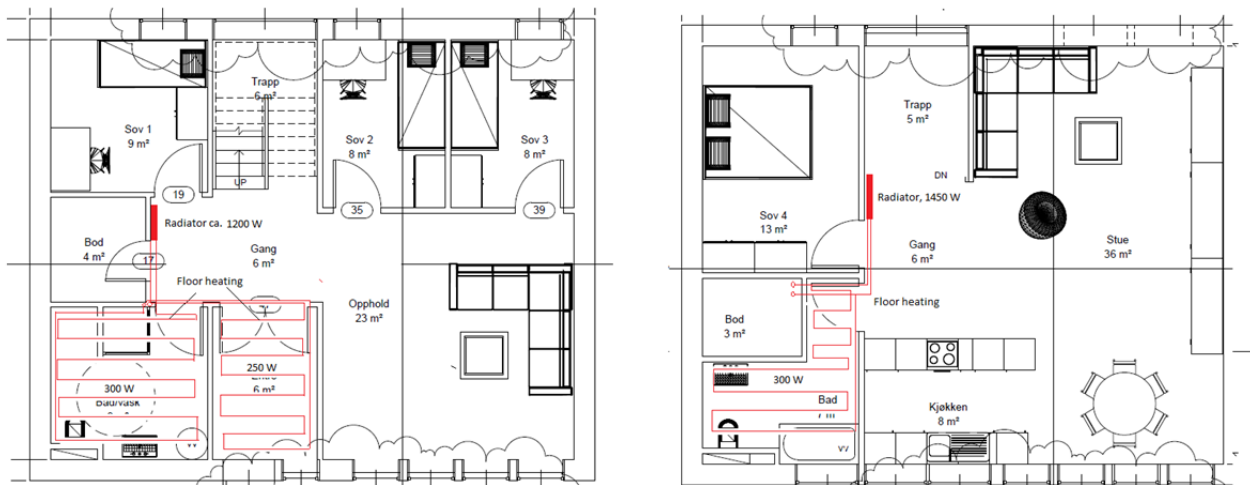

Figure D.1 Layout of the space-heating emission/distribution sub-system for the first (*left figure*) and second floor (*right figure*).

D.1 Simulation layout

The simulation diagram is shown in Figure 1.2. Polysun applies a holistic approach. The heating system typology is based on the template 19f of the Polysun database (heat pump + solar thermal):

- The space-heating (SH) needs are computed by Polysun given the main building properties as an input. The building model parameters were adapted in order to comply with the Norwegian passive house standard for residential buildings (i.e. following NS 3700:2010). A domestic hot water (DHW) tap profile should also be set as input. It has been selected in order to have an average value comparable to the passive house standard.
- The heat production is performed using an air-to-water heat pump coupled to solar thermal panels. Both contribute for the SH and DHW production. These two heating systems are coupled using a so-called combi-tank. The solar panels heat the lowest part of the tank through a heat exchanger. The stratified tank is in itself divided into two temperature zones. The upper part of the tank is devoted to DHW with a set-point temperature of 50-55°C and the lower part of the tank has a temperature adapted for the space-heating. In fact, the set-point temperature of the SH distribution loop is adapted as a function of the external temperature (i.e. a climatic regulation) so that the set-point temperature for the lower part of the tank is changed accordingly. Temperature sensors are placed in the upper part and the lower part of the tank. If a lack of temperature is detected in one part of the tank, the air-to-water heat pump starts and reloads the selected tank zone. This selection of zone to be reloaded is done by way of 2 three-way valves mounted between the heat pump and

the tank. For example, if the upper part is too cold then the valves open/close in a way that only the upper part of the tank is reloaded.

- As already introduced, two heat emitter types are applied to the building. For both emitters, the departure temperature of the SH distribution loops is adapted as a function of the outside temperature using a three-way valve. A same process is done to adapt the DHW tap temperature to 45°C, as the temperature of the upper part of the storage tank is higher. This rather low temperature level for the DHW draw-off gives a better COP for the heat pump and reduces the heat losses (compared to regimes of 50°C or 60°C).

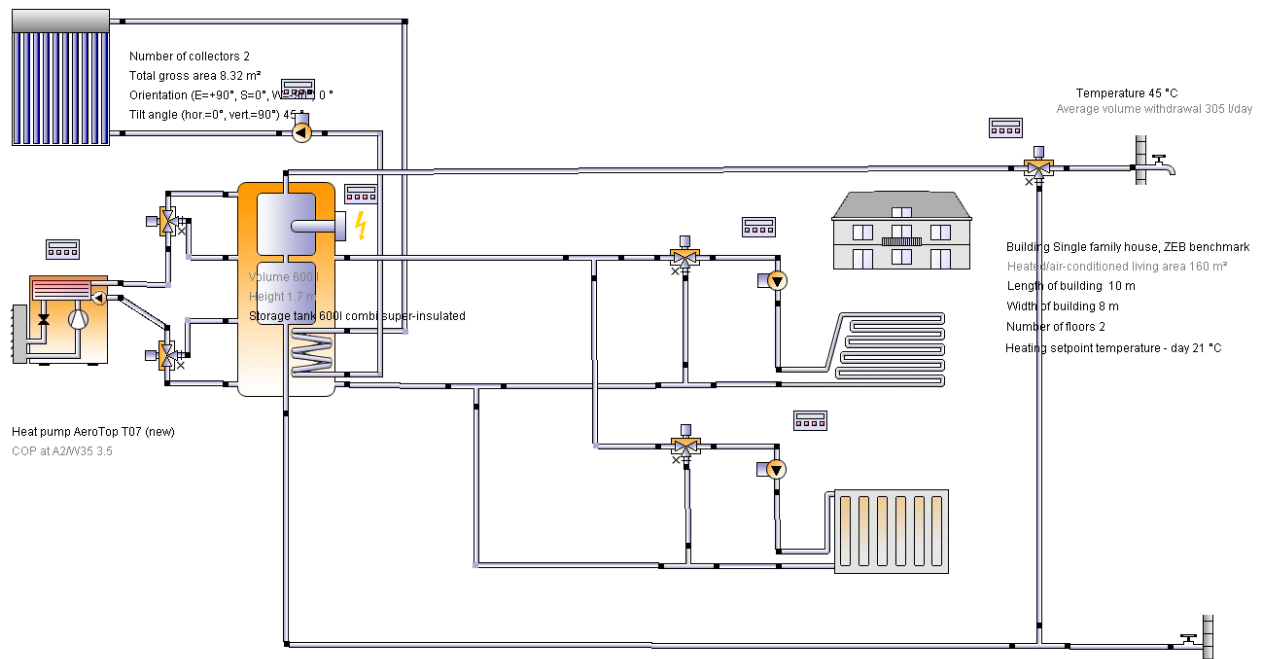

Figure D.2 Layout of the heating system applied to the benchmark ZEB detached house.

D.2 Parameters of the system and Polysun modeling assumptions

- Polysun models the thermal systems dynamically. The available results for the users are the model degrees of freedom (dof) averaged on a 1-h basis (e.g. temperatures, flow rates ...): the internal time-stepping of Polysun is indeed smaller than 1 h.
- The detached passive house has a reference heated surface of 160 m². The protected volume has 420 m³. In Polysun, the building is modeled using one thermal zone (i.e. mono-zone). The model is dynamic but has only one thermal capacitance for the whole building (i.e. irrespective if it is an internal or an external wall). The thermal mass is assumed high with a value set to 500 kJ/Km². Following the user manual and the number of parameters that can be introduced in the model, we assume that all external surfaces (opaque or window) are modeled by Polysun using a single thermal resistance. The usual parameters should be set to the building model: glazing area, g-factor of the glazing, the hygienic ventilation rate, the internal gains as well as the infiltration rate. All the parameters have been adapted to comply with the Norwegian passive house standard and to an existing SIMIEN file of the benchmark ZEB detached house. Nevertheless, given the large difference in modeling approaches, the SH needs computed by SIMIEN and Polysun are a bit different: 18.5 and 20 kWh/m².year, respectively. No attempt has

been made to tune the building parameters in Polysun to fit the SIMIEN results exactly. Global building parameters (e.g. global U-value) are taken equivalent.

- The major limitation of Polysun is that the building and energy systems are decoupled: the building needs are first evaluated by the Polysun building model and are then put as a requirement for the energy systems; on the contrary, the energy systems cannot influence the building model and, subsequently, the SH needs. The main consequence is that the thermal losses of the heating system (e.g. distribution pipes and the storage tank) are NOT introduced in the building model as internal gains. In fact, it is assumed that the heating system is placed in a technical room with constant temperature set by the software user. Heat losses are thus computed, but in an isothermal storage room located outside the building protected volume. The heating system is thus assumed to be located outside the protected volume, in a so-called storage room. Given the level of thermal insulation of the envelope and its specific space-heating needs (i.e. kWh/m².year), this assumption is very limiting: the utilization factor of internal gains is known to be high in passive envelopes. Contacts with the Polysun support showed that the improvement of their building model (to include the heat losses) is under development.
- As the building model is mono-zone, the simulation “cannot know” how to split the heating load between the floor heating and the radiators. In practice, it should at least require a multi-zone simulation. To circumvent this limitation, the following assumption is usually done in Polysun. The floor heating is supposed to be the base-load emitter while the radiators are only applied as a peak load when the floor heating is not able to cover the demand alone: the radiators are active if the temperature in the building is lower than the set-point temperature minus 0.5°C (i.e. 20.5°C in daytime) while the floor heating is immediately active at the set-point temperature (i.e. 21°C in daytime). Let us also mention that the user is not able to define the way the departure temperature of the hot water to the SH emitters is adapted as a function of the outdoor temperature (i.e. the so-called heating curve). The design temperatures of the floor heating is 35°C/25°C while it is set to 40°C/30°C for the radiators. Let us also mention that the way the circulation pumps in the SH distribution loops are controlled is not explicit in Polysun: the flow rate is well adapted as a function of the building needs but the pressure drop should depend on the pump regulation (e.g. constant or variable speed with constant or linearly-decreased set-point pressure).
- Given these approximations, it is pointless to try to model the losses inside the protected volume. The heat pump and the combi-tank are thus assumed to be located inside a storage room at 18°C. The three-way valves are also in this room. All the losses and pipes simulated in Polysun are assumed to be the part of the technical installation located in the storage room. In the model layout, only the heat emitters are inside the building. As in reality, there are technical equipments inside the protected volume (i.e. part of the SH and DHW distribution loops), it is assumed that the temperature drop inside the building envelope is negligible (quite acceptable), as well as the heat losses of these elements (large approximation). The pipes used are made in copper with an external diameter of 12 mm and an external thermal insulation of 20 mm of loose glass fiber and mineral wool ($\lambda = 0.045$ W/m.K). For the pipes of the solar panels loop located outside (not in the storage room), an extra-thickness of 20 mm has been applied (i.e. total of 40 mm).
- The DHW profile should also be commented. After defining the daily DHW needs (here 305 l/j at 45°C), the user has to specify how the needs are distributed within the day. The daily profile is defined on a hourly-basis. If the DHW needs are different than zero at a given hour, it is implicitly assumed in Polysun that the tap is only open one time during this hour. This is also a limiting modeling approach as the number of tap openings is a major parameter to define the losses of a

DHW distribution loop (i.e. the amount of spoiled hot water that is buffered in the pipes and that cools down in the building).

- The influence of a grey-water heat recovery system is also investigated. For example, the Norwegian manufacturer OSO proposes a model called *Energy Saver*, see Figure 1.3. The manufacturer communicates an energy recovery higher than 40% (the definition of this efficiency is not given). In practice, the physics of a grey-water heat recovery is difficult to model. For instance, the typical amount of cold water mixed to the DHW hot water should be known for each draw-off points in the buildings (i.e. each sink, showers or bath). In practice, the cold water can be directly mixed in order to adapt the instantaneous hot-water temperature to the user needs, or a sink can sometimes be used to draw-off only cold water. In any case, the extracted cold water is finally mixed to the hot water in the grey-water heat recovery. Finally, part of the grey water energy can be lost in the grey-water draining system between the draw-off points and the heat recovery system. On the contrary, a draw-off of cold water can be heated by the building ambient temperature. Altogether, this makes the modeling very complex. Although simple, the grey-water heat recovery is modeled in the following way. Without heat recovery, the cold water from the utility network is assumed to have an average temperature of 8°C and to follow a yearly sinusoidal evolution with an amplitude of 4°C (the maximum is located at the beginning of September), see Figure 1.4. The heat recovery is assumed to be a pre-heating of this network cold water by the 45°C draw-off DHW water. A thermal efficiency is assumed for this heat exchange: 20% and 40% are here analyzed. In other words, the grey-water heat recovery is considered as a reduction of the DHW needs by a pre-heating of the network cold water. Yearly temperature profiles of the pre-heated cold water temperature are shown in Figure 1.4.

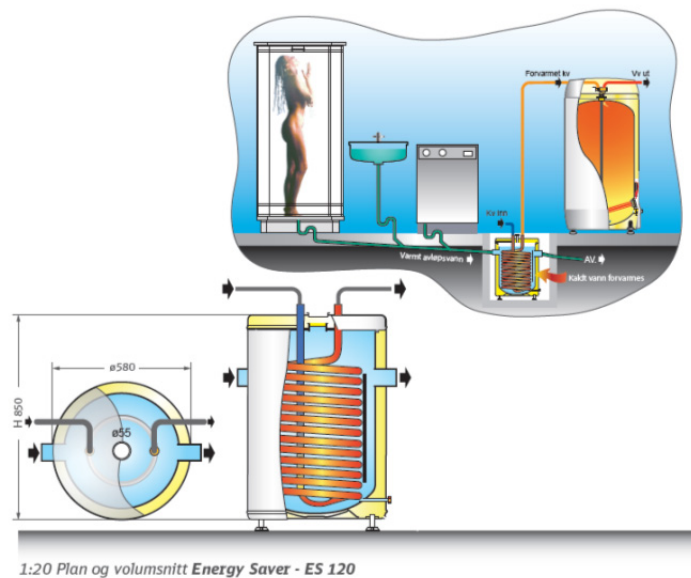

Figure D.3 Sketch of the grey-water heat exchanger of OSO
<http://www.osohotwater.no/boligprodukter/energy-saver.html>

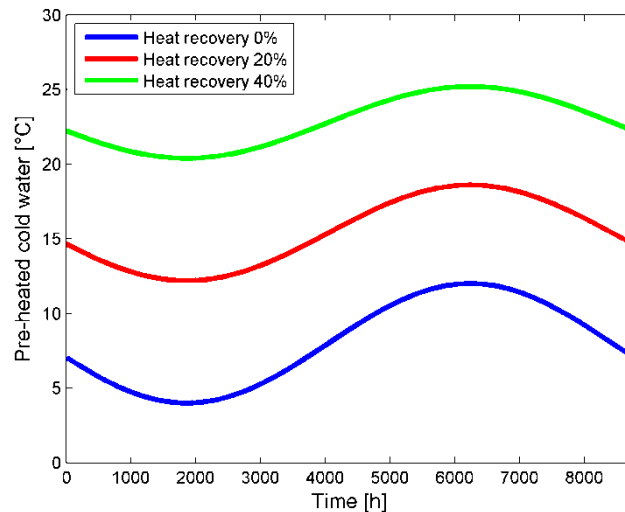

Figure D.4 Yearly temperature evolution of the pre-heated cold water; the profiles depends on the grey-water heat recovery efficiency (here assumed as a direct heat exchanger with the 45°C draw-off temperature).

- The solar thermal collectors are the vacuum-tube collectors **AP-30** from the manufacturer Apricus. This model was already implemented in the Polysun product database but the performance curve was nevertheless adapted to newer values communicated in the manufacturer's documentation (cfr. AP-30 documentation of the 19th August 2011): $\eta_0 = 0.687$, $a_1 = 1.505 \text{ W/m}^2\cdot\text{K}$ and $a_2 = 0.0111 \text{ W/m}^2\cdot\text{K}$. The circulation pump of the collector circuit is activated if the difference of temperature between the lower part of the combi-tank and the outlet temperature of the panels is higher than 6°C and stops if the temperature drops down 2°C. For the climate of Oslo, the optimal tilt angle of the panels is approximately 40°. In the present study, two tilt angles are considered: 45° which is representative of the optimal angle, vertically integrated in the façade in order to leave the roof available for photovoltaic panels (PV). Finally, the panels are oriented towards the South.
- A few words should be said about the storage tank:
 - The height of the tank is 1.7 m. A baseline volume of 600 liters is considered but 400 liters was also considered as a comparative test case.
 - The thermal insulation is rigid PU foam with a width of 15 cm. The yearly heat losses are approximately ~300 kWh/year. Nevertheless, as the results will show, the connection losses are even more important. These losses are not often taken into account and mimic the connection to the storage tank (here 8 connections). These connections can be seen as thermal bridges through the buffer tank thermal insulation. When defining the connection characteristics, the best equipment has been selected with the lowest connection losses (expressed in W/K). Even considering the best connections, the connection heat losses of the tank are ~350 kWh/year, which is considerable. Adding the transmission losses of the tank (i.e. ~350 kWh/year), one ends up with ~650 kWh/year of thermal losses for the tank. Compared to the 3200 kWh/year of space-heating needs, the tank losses are far to be negligible. This proves that one should use a fully-coupled approach when investigating the heat losses of energy systems in a passive envelope (in place of a decoupled approach).
 - Finally, the heat pump always produces a temperature between 50° and 55°C in the DHW tank. This range of temperature may be enough high to prevent to proliferation of legionella. Nevertheless, the impact of an anti-legionella disinfection strategy is also considered. This is done using the backup electric resistance installed in the tank in order to heat up the stored water to temperatures higher than 55°C (as the air-to-water heat pump is not able to reach

this range of temperatures). A first anti-legionella strategy considers a daily heat up of the DHW to 60° during 1h in the morning. A second anti-legionella strategy only considers a weekly heat up of the DHW to 70°C during 1h on Sunday's morning.

- The heat pump modeling and characteristics should also be commented:
 - The air-to-water heat pump AEROTOP of the manufacturer Elco has been selected. First, the COP presents values comparable to other high-performance products (e.g. the Ecodan of Mistubishi, Vitocal 300A of Viessman). Second, the technical documentation is available online (cfr www.elco.ch), in particular the COP values at the different test points (here following EN255), see Table 1.2 and Figure 1.5. This information is mandatory for the air-to-water heat pump model of Polysun. For example, considering the 7kW **AEROTOP T07**, the COP is 4.1 for A7/W35, 3.5 for A2/W35 and 2.6 for A-7/W35. The minimal operating outdoor temperature is -15°C but this parameter is not set into the Polysun model. During simulations, the minimal external air temperature is -15°C so that it is thus acceptable.
 - The Polysun model only mimics an *on/off control* of the heat pump: the heat pump works at full load or not. It is not really a problem here as the heat pump performs a so-called *staged-loading* of the tank: the tank temperature is loaded progressively with the temperature of the condenser increasing progressively. In this way, the COP is different for the production of SH and DHW. The problem with on/off control would have been problematic if the heat pump had been connected directly to the SH distribution sub-system (i.e. with a set-point temperature to be respected by the outlet water temperature from the heat pump). Then, the on-off control would increase the number of start-stop phases compared to a modulating heat pump (e.g. equipped with an inverter technology). Furthermore, we are in presence of a quite large oversizing of the heating system which tends to reduce the cycle duration: the baseline heat pump has a nominal power of 7 kW while the building SH power need is about 3 kW. Fortunately, in the present study, a storage tank is placed between the conversion and the distribution sub-systems.
 - The heat pump is here operated in **monovalent** mode. In the present case, the heat pump loads approximately one third of the tank (i.e. 200 liters) with a temperature differential of 5°C. At full load, it leads to a minimal cycle length of 10 min. From a wearing point of view, it seems acceptable. Simulations confirm that, using a typical meteorological year file (extracted from Meteoronorm), the 7 kW heat pump can cover all the user needs. A 10 kW version has also been tested as a point of comparison, even though it may lead in practice to more frequent on-off cycles.
 - The modeling procedure of Polysun is quite straightforward. For a given operating condition, it interpolates the performance of the heat pump between the test points of EN255 or EN14511. In fact, the external outdoor temperature (T_{ext}) and the water outlet temperature (from the condenser) (T_{out}) is first estimated by Polysun. From these conditions, the power delivered to the water (P_{th}) and to the compressor (P_e) is interpolated between the test points. The fact is that Polysun does not introduce any limitation for the minimal external temperature for a correct operation ($T_{ext,min}$), as already discussed (see Figure 1.6.). Furthermore, in Polysun, there is no consistent way to introduce a limitation of the maximal water temperature from the condenser ($T_{out,max}$). In practice, in cold conditions, this temperature is strongly dependant on the external temperature. For example, the AEROTOP maximal temperature $T_{out,max}$ is 55°C at $T_{ext} = -10^\circ\text{C}$ and 45°C at $T_{ext} = -15^\circ\text{C}$ (see graph above). In practice, Polysun allows to introduce one fixed limiting temperature at the condenser (independent of T_{ext}). As a consequence, the model is correct except for lowest outside temperatures. In many air-to-water heat pumps, the $T_{out,max}$ is limited to 50°C-55°C. In order to avoid the use of an electric resistance (i.e. bivalent mode), the DHW draw-off temperature has been here selected at 45°C, a value often encountered in the literature. In this way, the DHW water is stored in the tank between 50°C and 55°C. It is thus

manageable for air-to-water heat pumps with a $T_{out,max}$ of 55°C. There is the question of the behavior for the lowest temperature where not all air-to-water heat pumps can produce water at 55°C. This is not addressed in the present modeling approach but, in practice, it will require the backup electric resistance to be active during the coldest days.

- Finally, no heat losses to the surrounding environment are modeled by Polysun for the heat pump (while they are modeled for boilers). This is maybe a minor approximation given that it is assumed that the heat pump is located in the technical room. In the context of a heat pump located inside the protected volume, this approximation could be more problematic.

D.3 Results and discussion

The present section only aims at commenting and discussing the results, as well as their possible improvements. The default case is a **monovalent** 7kW air-to-water heat pump connected to a 600 litres combi-tank and two solar thermal panels (i.e. 8.32 m²). Unless stated otherwise, this case is considered. Results exported from Polysun are put in Annex.

The definition of the different performance indexes is first introduced:

- The **solar fraction** (SF) is the ratio of the energy delivered by the solar thermal panels to the tank to the total energy delivered to the storage tank (i.e. solar panel and heat generators). The SF to the space-heating (SH) and DHW are an approximation done by Polysun.
- The **overall efficiency** considering the grey-water heat exchanger is the ratio between the user demands to the total electricity consumption of the installation. This considers the performance of the installation with a system boundary that includes the heat recovery unit. This is the most important performance index. Although the SH and the DHW demand are not tuned exactly on the SIMIEN results, it is expected that this overall efficiency will not change much with these differences in energy needs. In practice, we recommend that the delivered energy to the house (here electricity) is rescaled using the overall efficiency and the needs defined in SIMIEN, instead of considering directly the output of Polysun as the reference/absolute delivered energy.

Then, results, reported on Table 1.1, lead to the following conclusions:

- Without grey-water heat recovery and using vertical solar collectors, the overall seasonal system performance is **3.37** without anti-legionella strategy. The daily heat up at 60°C reduces the overall efficiency to 3.12 while the weekly disinfection only degrades the efficiency to 3.28. As a conclusion, the anti-legionella strategy has a significant impact on the overall installation efficiency.
- The pre-heating performed by the grey-water heat recovery significantly improves the overall performance: from 3.37 without heat recovery to **4.55** for the 40% heat exchange (without anti-legionella strategy). From the author's point of view, such a large improvement was not expected. In fact, the heat exchanger is performing a pre-heating of the cold water; an operation that is otherwise done by the heat pump or the solar thermal collectors. At this range of temperature (below 25°C), the performance of both systems is quite good. Nevertheless, from simulations results, it seems like this pre-heating performs relatively well. Before proceeding any further, it is worth mentioning again that the modeling approach of the grey-water heat recovery was rather simple compared to the real physics.
- The increase of the nominal power of the heat pump from 7 to 10kW does not modify the results significantly. In practice, the correct dimensioning should be done in order to fulfill two conflicting design constraints. In the one hand, the nominal power should be large enough to enable the heat pump to work in monovalent mode, even in the coldest day of the year. Furthermore, the power should be in good accordance with the size of the DHW internal tank. In the other hand,

the nominal power should not be too large to prevent too frequent on-off cycling of the heat pump. It is indeed well-known that frequent cycling leads to a premature mechanical wear of the heat pump. We recommend selecting the highest nominal power possible without introducing too frequent on-off cycling. It should be established as a function of the manufacturer recommendations. 7 or 10kW lead to cycles of about 10min, which seems reasonable.

- It is important to recall the domain of application and the limitations. The model corresponds to a heating installation placed in a technical room. This limitation is imposed by Polysun. The selected storage room temperature is here fixed at 18°C. Furthermore, the maximal outlet temperature of the heat pumps, $T_{out,max}$, is considered constant (i.e. not dependant of the outdoor temperature). In practice, the contribution of the backup electric resistance will be higher than simulated in the present work: in the coldest days, this resistance will heat up the DHW to 55°C when the heat pump is not able to do it.
- The heat losses are large. In fact, they amount to 1017 kWh/year, here emitted to the storage room (outside the protected volume). The main contribution for these losses originates from the buffer tank. Using the 600 litres tank, it corresponds to 316 kWh/year of transmission losses and to 350 kWh/year of connection losses. These losses are also present out of the heating season. Nevertheless, compared the SH needs of the passive house (i.e. 3200 kWh/year), these losses are far to be negligible. In practice, if the storage is located inside the building envelope, a part of these thermal losses will be recovered for the space-heating of the building. This effect can only be accounted for in a fully-coupled approach (e.g. using TRNSYS). It is far to be obvious to trick the simulation modeling of Polysun to integrate the heat losses into the building model.

Table D.1 Summary of the computed efficiencies: scenario “A” is a DHW storage between 50°C/55°C without legionella strategy, scenario “B” is equivalent to “A” but including a daily heat-up at 60°C during 1h every morning, scenario “C” is equivalent to “A” but including a weekly heat-up at 70°C during 1h every Sunday. Baseline cases are shaded in orange.

| Case ID number | HP type [kW] | Buffer size [litre] | Grey-water heat exchanger efficiency [%] | Solar thermal panels area [m ²] | Solar thermal panels tilt angle | DHW temperature and legionella strategy | Overall solar fraction [%] | Estimated DHW solar fraction [%] | Estimated SH solar fraction [%] | Overall efficiency (including grey water heat recovery) | Heat pump SPF |
|----------------|--------------|---------------------|--|---|---------------------------------|---|----------------------------|----------------------------------|---------------------------------|---|---------------|
| 1 | 7kW | 600l | 0% | 8.32 | 45° | A | 45.8% | 62.3% | 12.7% | 3.65 | 2.28 |
| 2 | 7kW | 600l | 0% | 8.32 | 90° | A | 39.1% | 52.2% | 12.8% | 3.37 | 2.35 |
| 3 | 7kW | 600l | 0% | 8.32 | 90° | B | 39.2% | 52.4% | 12.8% | 3.12 | 2.34 |
| 4 | 7kW | 600l | 0% | 8.32 | 90° | C | 39.0% | 52.1% | 12.7% | 3.28 | 2.35 |
| 5 | 7kW | 600l | 20% | 8.32 | 45° | A | 46.7% | 66.1% | 13.6% | 4.08 | 2.26 |
| 6 | 7kW | 600l | 20% | 8.32 | 90° | A | 41.7% | 58.9% | 13.7% | 3.85 | 2.31 |
| 7 | 7kW | 600l | 20% | 8.32 | 90° | B | 41.8% | 58.9% | 13.7% | 3.54 | 2.30 |
| 8 | 7kW | 600l | 20% | 8.32 | 90° | C | 41.6% | 58.9% | 13.7% | 3.74 | 2.31 |
| 9 | 7kW | 600l | 40% | 8.32 | 45° | A | 46.7% | 69.3% | 14.8% | 4.55 | 2.24 |
| 10 | 7kW | 600l | 40% | 8.32 | 90° | A | 43.7% | 64.5% | 14.9% | 4.40 | 2.27 |
| 11 | 7kW | 600l | 40% | 8.32 | 90° | B | 43.6% | 64.5% | 14.9% | 4.07 | 2.26 |
| 12 | 7kW | 600l | 40% | 8.32 | 90° | C | 43.6% | 64.3% | 14.9% | 4.31 | 2.27 |
| | | | | | | | | | | | |
| 13 | 10kW | 600l | 0% | 0.00 | 90° | A | 0.0% | 0.0% | 0.0% | 2.32 | 2.54 |
| 14 | 10kW | 600l | 0% | 4.16 | 90° | A | 22.3% | 34.8% | 6.9% | 2.77 | 2.44 |
| 15 | 10kW | 600l | 0% | 8.32 | 90° | A | 39.0% | 52.1% | 12.7% | 3.36 | 2.38 |
| 16 | 10kW | 600l | 0% | 12.4 | 90° | A | 47.4% | 62.5% | 17.7% | 3.80 | 2.30 |

Table D.2 Performance of the Elco air-to-water heat pump (www.elco.ch).

AEROTOP T07 -T16 (selon données EN 255)

| Série | | AEROTOP T07 | | | AEROTOP T10 | | | AEROTOP T12 | | | AEROTOP T14 | | | AEROTOP T16 | | |
|----------------|----------------|-------------|-----|-----|-------------|-----|-----|-------------|-----|-----|-------------|-----|-----|-------------|-----|-----|
| T _K | T _L | Q | P | COP | Q | P | COP | Q | P | COP | Q | P | COP | Q | P | COP |
| °C | °C | kW | kW | - | kW | kW | - | kW | kW | - | kW | kW | - | kW | kW | - |
| 35 | 20 | 9,9 | 1,9 | 5,2 | 14,4 | 2,8 | 5,2 | 17,7 | 3,4 | 5,2 | 20,8 | 4,1 | 5,1 | 21,8 | 4,5 | 4,9 |
| | 15 | 9,7 | 1,9 | 5,1 | 14 | 2,8 | 5 | 17,3 | 3,4 | 5 | 19,7 | 4,1 | 4,8 | 21,1 | 4,4 | 4,8 |
| | 7 | 7,7 | 1,9 | 4,1 | 10,9 | 2,8 | 3,9 | 13,7 | 3,3 | 4,1 | 16,2 | 4 | 4,1 | 18,5 | 4,3 | 4,3 |
| | 4 | 7 | 1,9 | 3,8 | 10,2 | 2,8 | 3,7 | 12,5 | 3,3 | 3,8 | 14,7 | 3,9 | 3,7 | 16,4 | 4,2 | 3,9 |
| | 2 | 6,6 | 1,9 | 3,5 | 9,7 | 2,7 | 3,5 | 11,6 | 3,3 | 3,6 | 13,6 | 3,9 | 3,5 | 15,1 | 4,1 | 3,7 |
| | 0 | 6,2 | 1,9 | 3,3 | 9,2 | 2,8 | 3,3 | 11 | 3,3 | 3,4 | 13,3 | 3,9 | 3,4 | 14,6 | 4,1 | 3,6 |
| | -4 | 5,5 | 1,9 | 2,9 | 8,1 | 2,8 | 2,9 | 9,6 | 3,2 | 3 | 12,5 | 4,0 | 3,2 | 13,6 | 4,0 | 3,4 |
| | -7 | 4,9 | 1,9 | 2,6 | 7,3 | 2,8 | 2,6 | 8,5 | 3,2 | 2,6 | 12 | 4 | 3 | 13,0 | 3,9 | 3,3 |
| | -10 | 4,3 | 1,9 | 2,3 | 6,6 | 2,8 | 2,4 | 7,5 | 3,2 | 2,3 | 11,4 | 4,0 | 2,9 | 12,3 | 3,8 | 3,2 |
| | -15 | 3,4 | 1,9 | 1,8 | 5,2 | 2,8 | 1,9 | 5,8 | 3,2 | 1,8 | 10,5 | 4,0 | 2,6 | 11,1 | 3,6 | 3,1 |
| 40 | 20 | 9,8 | 2,1 | 4,7 | 14,2 | 3,1 | 4,7 | 17,5 | 3,8 | 4,7 | 20,5 | 4,6 | 4,6 | 21,6 | 4,9 | 4,5 |
| | 15 | 9,6 | 2,1 | 4,6 | 13,9 | 3,2 | 4,5 | 17,1 | 3,8 | 4,6 | 19,4 | 4,6 | 4,3 | 21,0 | 4,8 | 4,4 |
| | 7 | 7,5 | 2,1 | 3,7 | 10,8 | 3,1 | 3,6 | 13,3 | 3,7 | 3,7 | 15,7 | 4,4 | 3,6 | 18,4 | 4,7 | 4,0 |
| | 4 | 6,9 | 2,1 | 3,4 | 10,1 | 3,1 | 3,3 | 12,1 | 3,6 | 3,4 | 14,4 | 4,4 | 3,4 | 16,3 | 4,6 | 3,6 |
| | 2 | 6,5 | 2,1 | 3,2 | 9,6 | 3,1 | 3,2 | 11,3 | 3,6 | 3,2 | 13,5 | 4,4 | 3,2 | 14,9 | 4,5 | 3,3 |
| | 0 | 6,1 | 2,1 | 3,0 | 9,1 | 3,1 | 3,0 | 10,7 | 3,6 | 3,0 | 13,2 | 4,4 | 3,1 | 14,4 | 4,5 | 3,3 |
| | -4 | 5,4 | 2,1 | 2,6 | 8 | 3,1 | 2,7 | 9,4 | 3,6 | 2,7 | 12,5 | 4,4 | 2,9 | 13,5 | 4,3 | 3,2 |
| | -7 | 4,9 | 2,1 | 2,4 | 7,3 | 3,1 | 2,4 | 8,4 | 3,5 | 2,4 | 11,9 | 4,4 | 2,7 | 12,8 | 4,2 | 3,1 |
| | -10 | 4,3 | 2,1 | 2,1 | 6,5 | 3,1 | 2,1 | 7,4 | 3,5 | 2,1 | 11,4 | 4,5 | 2,6 | 12,1 | 4,1 | 3,0 |
| | -15 | 3,4 | 2,1 | 1,7 | 5,2 | 3,2 | 1,7 | 5,8 | 3,5 | 1,7 | 10,4 | 4,5 | 2,4 | 11,0 | 4,0 | 2,8 |
| 45 | 20 | 9,8 | 2,3 | 4,3 | 14,1 | 3,5 | 4,2 | 17,3 | 4,1 | 4,3 | 20,2 | 5,1 | 4,1 | 21,5 | 5,3 | 4,1 |
| | 15 | 9,5 | 2,3 | 4,1 | 13,7 | 3,5 | 4 | 16,9 | 4,1 | 4,2 | 19 | 5,1 | 3,8 | 21,0 | 5,2 | 4,1 |
| | 7 | 7,3 | 2,3 | 3,2 | 10,7 | 3,5 | 3,2 | 12,8 | 4 | 3,3 | 15,2 | 4,8 | 3,2 | 18,2 | 5,0 | 3,7 |
| | 4 | 6,7 | 2,3 | 3 | 9,9 | 3,4 | 3 | 11,7 | 3,9 | 3 | 14,1 | 4,8 | 3 | 16,1 | 4,9 | 3,3 |
| | 2 | 6,3 | 2,3 | 2,8 | 9,4 | 3,4 | 2,8 | 11 | 3,9 | 2,9 | 13,4 | 4,8 | 2,8 | 14,7 | 4,9 | 3,1 |
| | 0 | 6 | 2,3 | 2,7 | 9 | 3,4 | 2,7 | 10,4 | 3,9 | 2,7 | 13,1 | 4,8 | 2,8 | 14,3 | 4,8 | 3,0 |
| | -4 | 5,3 | 2,3 | 2,4 | 8 | 3,4 | 2,4 | 9,2 | 3,9 | 2,4 | 12,4 | 4,9 | 2,6 | 13,4 | 4,7 | 2,9 |
| | -7 | 4,8 | 2,3 | 2,1 | 7,2 | 3,5 | 2,1 | 8,2 | 3,8 | 2,2 | 11,8 | 4,9 | 2,5 | 12,7 | 4,6 | 2,8 |
| | -10 | 4,3 | 2,3 | 1,9 | 6,5 | 3,5 | 1,9 | 7,3 | 3,8 | 2 | 11,3 | 4,9 | 2,3 | 12,0 | 4,5 | 2,7 |
| | -15 | 3,5 | 2,3 | 1,5 | 5,2 | 3,5 | 1,5 | 5,8 | 3,8 | 1,6 | 10,4 | 5 | 2,1 | 10,9 | 4,3 | 2,6 |
| 50 | 20 | 9,7 | 2,6 | 3,8 | 13,9 | 3,8 | 3,6 | 17,1 | 4,5 | 3,8 | 20 | 5,6 | 3,6 | 21,3 | 5,7 | 3,8 |
| | 15 | 9,4 | 2,6 | 3,7 | 13,6 | 3,9 | 3,5 | 16,7 | 4,5 | 3,7 | 18,6 | 5,6 | 3,3 | 21,0 | 5,6 | 3,7 |
| | 7 | 7,1 | 2,5 | 2,8 | 10,6 | 3,8 | 2,8 | 12,3 | 4,3 | 2,8 | 14,7 | 5,3 | 2,8 | 18,1 | 5,4 | 3,3 |
| | 4 | 6,5 | 2,5 | 2,6 | 9,8 | 3,8 | 2,6 | 11,4 | 4,3 | 2,7 | 13,9 | 5,3 | 2,6 | 16,0 | 5,3 | 3,0 |
| | 2 | 6,2 | 2,5 | 2,5 | 9,3 | 3,8 | 2,5 | 10,7 | 4,2 | 2,5 | 13,3 | 5,3 | 2,5 | 14,6 | 5,3 | 2,8 |
| | 0 | 5,9 | 2,5 | 2,3 | 8,8 | 3,8 | 2,4 | 10,1 | 4,2 | 2,4 | 13 | 5,3 | 2,5 | 14,1 | 5,2 | 2,7 |
| | -4 | 5,2 | 2,5 | 2,1 | 7,9 | 3,8 | 2,1 | 9 | 4,2 | 2,1 | 12,3 | 5,3 | 2,3 | 13,2 | 5,0 | 2,6 |
| | -7 | 4,7 | 2,5 | 1,9 | 7,1 | 3,8 | 1,9 | 8,1 | 4,1 | 2 | 11,7 | 5,4 | 2,2 | 12,6 | 4,9 | 2,5 |
| | -10 | 4,3 | 2,5 | 1,7 | 6,4 | 3,8 | 1,7 | 7,2 | 4,1 | 1,8 | 11,2 | 5,4 | 2,1 | 11,9 | 4,8 | 2,5 |

T_K Température de sortie d'eau (départ) en °C
 T_L Température d'entrée d'eau en °C
 Q Puissance de chauffe en kW
 P Puissance absorbée en kW
 COP Coefficient de performance

Les Intensités absorbées par le ventilateur et la pompe à chaleur ainsi que par le dégivrage sont en général comprises.

Débits d'eau de chauffage et d'air selon données aux pages Données techniques.

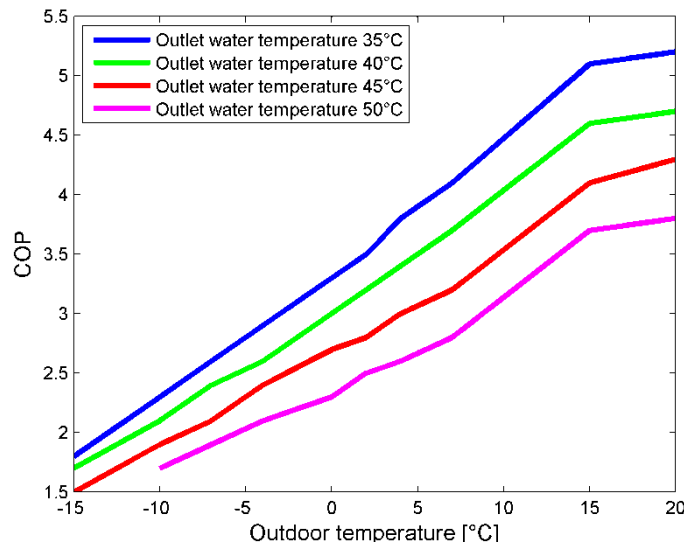

Figure D.5 Performance of the Elco AEROTOP T07 heat pump (www.elco.ch).

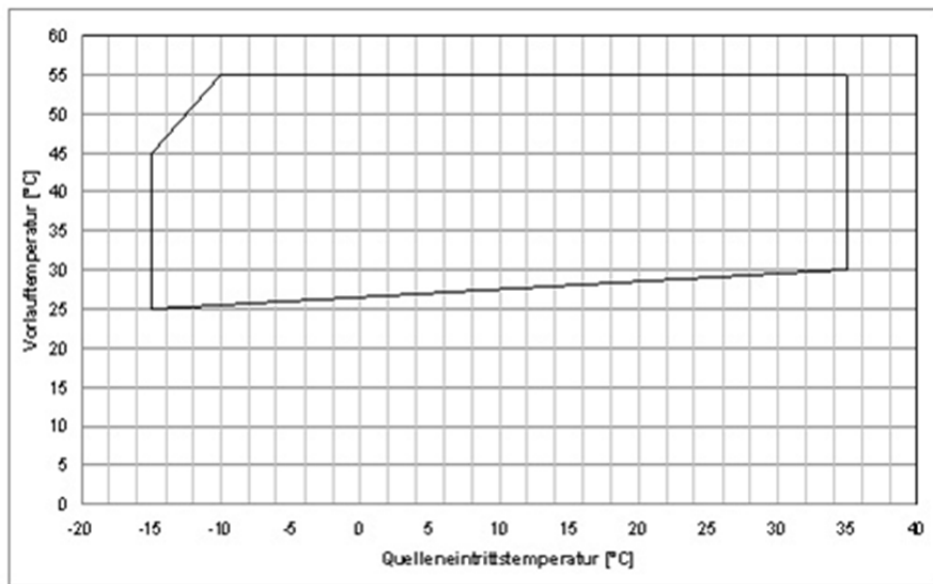

Figure D.6 Operational temperature domain for the Elco AEROTOP T07 heat pump (www.elco.ch)

Appendix E MATERIAL INVENTORY FOR LCA

The table below shows the material inventory used in the analysis. The construction column refers to the construction part involved and the relevant number from the table of building elements. The lifetime is shown in years and the source of the environmental data used is given in the column showing which process was used.

| Construction | Nr. | Material input | Amount | Unit | Lifetime in years | SIMAPRO/Ecoinvent Process used |
|---------------------------------|------|---|--------|----------------|-------------------|---|
| 21 Foundation | | | | | | |
| 214 Support structures | 2141 | | | | | |
| 216 Direct foundation | 2161 | Concrete | 31,9 | m ³ | 60 | Concrete, normal, at plant/CH U |
| | | Rigid Insulation EPS / thermal barrier (floor slab) | 757,8 | kg | 60 | Expanded Polystyrene foam slab, at plant/RER |
| | | Damp proof membrane / vapour moisture barrier | 157,92 | kg | 60 | Plastic polyethylene (LDPE) |
| | | Parkett (Input missing from BIM - estimate based on parkett m3 -check*) | 1,045 | m ³ | 15 | Massivholz Buche, Eiche, kammergetrocknet, gehobelt (EMPA) |
| | | Radon membrane ISOLA Radon sperre 400 400g/m2 TG2387 (input missing from BIM) | | | | |
| | | Insulation TG2387 (Needs estimate exterior) | | | | |
| 22 Bearing constructions | | | | | | |
| 223 Beams | 2231 | Load bearing Steel Beam | 800 | kg | 60 | Steel, low-alloyed, at plant/RER U ZEB |
| 23 Outer walls | | | | | | |
| 231 Bearing outer wall | 2311 | Timber (Trestendre/woodwork) | 5691,6 | kg | 60 | Massivholz Fichte / Tanne / Lärche, Scandinavian, sägerau, entrindat |
| | 2312 | Insulation | 2480 | kg | 60 | Glass wool mat, at plant/CH U |
| | 2312 | Plasterboard | 3524,4 | kg | 60 | Gypsum plaster board, at plant/CH U |
| | 2313 | Vapour moisture barrier (PE foil) | 334,64 | kg | 60 | Polyethylene, LDPE, granulate, at plant/RER U |
| | 2314 | Wind barrier (Vindsperre rull basert) | 231,4 | kg | 60 | Kraftpapier |
| 232 Non-Bearing outer walls | 2321 | | | | | |
| 234 Windows | 2341 | Window Frame (transom) | 243,54 | kg | 30 | Massivholz Fichte / Tanne / Lärche Schweiz, kammergetrocknet, gehobelt |
| | 2342 | Door Frame (timber) | 61,38 | kg | 30 | Massivholz Fichte / Tanne / Lärche Schweiz, kammergetrocknet, gehobelt |
| | 2343 | Glass Window | 1522,5 | kg | 30 | Door, outer, wood-aluminium, at plant/RER U |
| 235 Facade material | 2351 | Facade material - Pine - CEMBRIT (Input for parapet) | 540 | kg | 30 | EPD- Cembrit Etna True- Fiber cement To gate - Finland - 2012 (Data input Faserzementplatte gross) |
| | 2352 | Facade material - Plywood MDF (Input for parapet) | 995,28 | kg | 30 | Gypsum plaster board, at plant/CH |
| | 2353 | Wood Pine Cladding | 2764,7 | kg | 30 | Sawn timber, softwood, planed, air dried, at plant / RER U |
| 24 Inner walls | | | | | | |
| 241 Bearing inner walls | 2411 | Timber (Trestendre/woodwork) | 146,9 | kg | 60 | Massivholz Fichte / Tanne / Lärche, Scandinavian, sägerau, entrindat |
| | 2412 | Insulation | 64,0 | kg | 60 | Glass wool mat, at plant/CH U |
| | 2413 | Plasterboard | 362,7 | kg | 60 | Gypsum plaster board, at plant/CH U |
| 242 Non bearing inner walls | 2421 | Timber (Trestendre/woodwork) | 578,3 | kg | 60 | Massivholz Fichte / Tanne / Lärche, Scandinavian, sägerau, entrindat |
| | 2422 | Insulation | 252,0 | kg | 60 | Glass wool mat, at plant/CH U |

| Construction | Nr. | Material input | Amount | Unit | Lifetime in years | SIMAPRO/Ecoinvent Process used |
|--|------|--|---------|----------------|-------------------|---|
| | 2422 | Insulation <i>(Shaft wall behind WC)</i> | 30,5 | kg | 60 | Glass wool mat, at plant/CH U |
| | 2423 | Plasterboard | 2106,0 | kg | 60 | Gypsum plaster board, at plant/CH U |
| | 2423 | Plasterboard <i>(Shaft wall behind WC)</i> | 89,1 | kg | 60 | Gypsum plaster board, at plant/CH U |
| 244 Windows and doors | 2441 | Glass pane in inner door | 62,5 | kg | 30 | Flat glass, coated, at plant/RER U |
| | 2443 | Timber doors | 490,1 | kg | 30 | Massivholz Fichte / Tanne / Lärche Schweiz, kammergetrocknet, gehobelt |
| 246 Cladding and Surface | 2461 | Ceramic Tiles | 2318,0 | kg | 60 | Ceramic tiles, at regional storage / CH U |
| 25 Structural Decks | | | | | | |
| 251 Loadbearing deck | 2513 | Wood Floor Truss Beam <i>(Gitterbjelker)</i> | 1398 | kg | 60 | Massivholz Fichte / Tanne / Lärche, Scandinavian, sägerau, entrindat |
| | 2514 | Insulation (truss) <i>(Not included in drawings)</i> | 749,6 | kg | 60 | Glass wool mat, at plant/CH U |
| 254 Floor systems | 2545 | Sponplater (MDF) | 1279,98 | kg | 30 | Medium density fibreboard, at plant/m3/RER |
| | 2546 | Wood Flooring <i>(Parkett 14mm)</i> | 747,18 | kg | 15 | Planed timber, softwood, at plant/ NO U or Massivholz Buche, Eiche, kammergetrocknet, gehobelt (EMPA) |
| | 2547 | Plastic <i>(Not shown in drawings Quantity from BIM)</i> | 0,119 | m ³ | 60 | |
| 257 Ceilings- System | 2572 | Gypsum | 873,00 | kg | 60 | Gypsum plaster board, at plant/CH U ZEB |
| | 2575 | Wood Battons lektor <i>[Pine (23mmx48mm)cc600]</i> | 118,50 | kg | 60 | Sawn timber, softwood, planed, air dried, at plant / RER U |
| 26 Outer roof | | | | | | |
| 261 Primary construction | 2611 | Wood Roof Truss Beam <i>(Gitterbjelker)</i> | 1666 | kg | 60 | Massivholz Fichte / Tanne / Lärche, Scandinavian, sägerau, entrindat |
| 262 Roof Covering | 2621 | Membrane | 693 | kg | 30 | Asfalt (ATB) (Asphaltdeckschicht) |
| | 2623 | Plywood | 1069,2 | kg | 60 | OSB/ 3 plate (15mm) |
| | 2622 | Insulation | 632,39 | kg | 60 | EPS 400mm (0,036 W/Mk) |
| | 2624 | Vapour Barrier | 158,86 | kg | 60 | PE Foil (0,2mm) Tyvek el. tilsvarende |
| | 2625 | Gypsum | 962,1 | kg | 60 | Gypsum plaster board (13mm), at plant/CH U |
| | | MDF <i>(Missing from drawing & BIM)</i> | | kg | 30 | Medium density fibreboard, at plant/m3/RER |
| 28 Stairs -balconies | | | | | | |
| 281 Inner stairs | 2811 | <i>(Not included in BIM)</i> | | | | |
| 29 Other | | | | | | |
| 291 Mass Inventory Heating | 291 | PEX piping, 17 X 2mm & PEX piping, 18mm | 18,4 | kg | 60 | PEX - High density polyethylene (HDPE) |
| | | Radiator | 98 | kg | 60 | Steel, low-alloyed, at plant/RER U (check*) |
| Mass inventory accumulator | | Hot water tank OSO EP2 400 <i>(600L capacity)</i> | 1 | P (unit) | 30 | Hot Water Tank 600l, at plant, CH |
| Mass inventory heat pump | | Boch EHP 7 LW/M <i>(146 kg)</i> | 1 | P (unit) | 20 | |
| | | Refrigerator fluid (R-407) <i>(1,35 kg)</i> | 1,35 | kg | 60 (check*) | Refrigerator R134a |
| 36 Ventilation & Air-conditioning | | | | | | |
| | | 200 mm DUCTS | 39 | kg | 60 | Ventilation duct, steel, 100x50 mm, at plant/RER U |
| | | 160 mm DUCTS | 18 | kg | 60 | Ventilation duct, steel, 100x50 mm, at plant/RER U |
| | | 125 mm DUCTS | 28 | kg | 60 | Ventilation duct, steel, 100x50 mm, at plant/RER U |
| | | Air handling unit | 67 | kg | 60 | Ventilation duct, steel, 100x50 mm, at plant/RER U |
| | | Kitchen fan unit | 40 | kg | 60 | Ventilation duct, steel, 100x50 mm, at plant/RER U |
| | | Combi intake/exhaust | 4 | kg | 60 | Ventilation duct, steel, 100x50 mm, at plant/RER U |

| Construction | Nr. | Material input | Amount | Unit | Lifetime in years | SIMAPRO/Ecoinvent Process used |
|--------------------------------|-----|---|--------|----------------|-------------------|---|
| | | | | | | U |
| 49 Electric | | | | | | |
| <i>Solar Thermal Collector</i> | | Solar Thermal Collector (<i>APRICUS AP30</i>) | 8,2 | m ² | 20 | Evacuated tube collector, at plant |
| <i>PV panel</i> | | PV module (<i>PV-module SunPower SPR 333NE WHT-D</i>) | 69 | m ² | 30 | Photovoltaic panel, single-Si, at plant/RER/I U |

Density of main material inputs

| Material | Density (kg/m ³) |
|--|------------------------------|
| Timber (<i>Trestendre/woodwork</i>) | 765 |
| Door & window frame (<i>Timber</i>) | 495 |
| Insulation – <i>EPS (Expanded polystyrene foam slab)</i> | 30 |
| Insulation (<i>Glass wool</i>) | 40 |
| Load Bearing steel beam | 7850 |
| Concrete | 2380 |
| Glass (<i>window</i>) | 2500 |
| Cembrit | 1800 |
| Gypsum plasterboard | 900 |
| MDF (<i>sponplater</i>) | 780 |
| OSB plate/3 plate (<i>15mm</i>) | 594 |
| PE foil - Plastic polyethylene (<i>LDPE</i>) | 940 |
| Ceramic Tiles | 1900 |
| Asphalt (<i>roof membrane</i>) | 2100 |

The Research Centre on Zero emission Buildings (ZEB)

The main objective of ZEB is to develop competitive products and solutions for existing and new buildings that will lead to market penetration of buildings that have zero emissions of greenhouse gases related to their production, operation and demolition. The Centre will encompass both residential and commercial buildings, as well as public buildings.

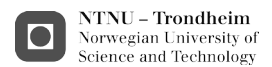

Partners

NTNU

www.ntnu.no

SINTEF

www.sintef.no

Skanska

www.skanska.no

Weber

www.weber-norge.no

Isola

www.isola.no

Glava

www.glava.no

Protan

www.protan.no

Hydro Aluminium

www.hydro.com

YIT

www.yit.no

ByBo

www.bybo.no

Multiconsult

www.multiconsult.no

Brødrene Dahl

www.dahl.no

Snohetta

www.snoarc.no

Forsvarsbygg

www.forsvarsbygg.no

Statsbygg

www.statsbygg.no

Husbanken

www.husbanken.no

Byggenæringens Landsforening

www.bnl.no

Norsk Teknologi

www.norskteknologi.no

Direktoratet for byggkvalitet

www.dibk.no

DuPont

www.dupont.com

NorDan AS

www.nordan.no

Enova

www.enova.no

Velux

www.velux.com

Entra

www.entra.no