

Tor Helge Dokka, Torhildur Kristjansdottir, Berit Time, Sofie Mellegård,
Matthias Haase and Jens Tønnesen

A zero emission concept analysis of an office building

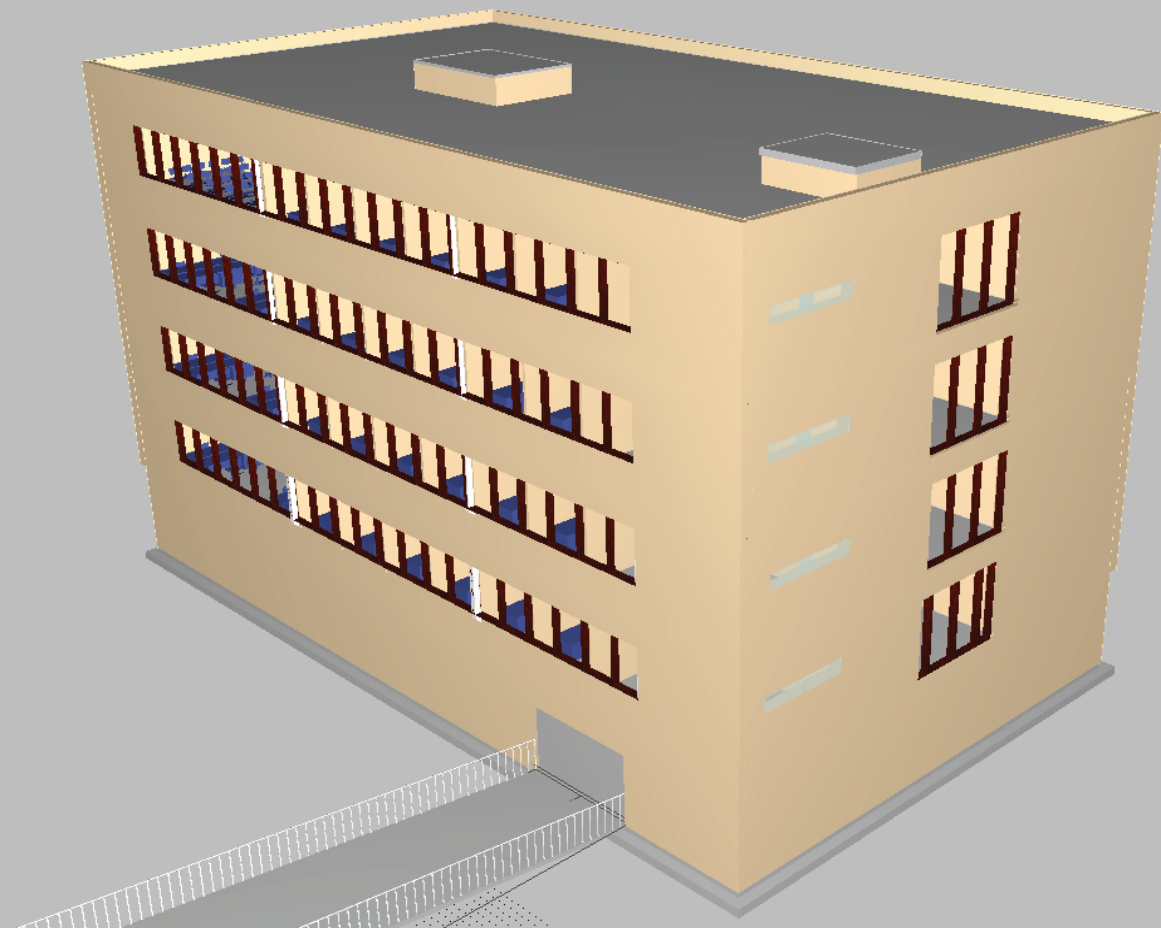

SINTEF Academic Press

Tor Helge Dokka ¹⁾, Torhildur Kristjansdottir ¹⁾, Berit Time ¹⁾, Sofie Mellegård ¹⁾,
Matthias Haase ¹⁾²⁾ and Jens Tønnesen ³⁾

A zero emission concept analysis of an office building



ZEB Project report 8 – 2013

ZEB Project report no 8

Tor Helge Dokka ¹⁾, Torhildur Kristjansdottir ¹⁾, Berit Time ¹⁾, Sofie Mellegård ¹⁾, Matthias Haase ¹⁾²⁾,
Jens Tønnesen ³⁾

A zero emission concept analysis of an office building

Keywords:

Zero emission building, office concept building, delivered energy, embodied energy, green house gas emissions, PV

ISSN 1893-157X (online)

ISSN 1893-1561

ISBN 978-82-536-1323-9 (pdf)

ISBN 978-82-536-1325-3 (printed)

28 copies printed by AIT AS e-dit

Content: 100 g Scandia

Cover: 240 g Trucard

© **Copyright SINTEF Academic Press and Norwegian University of Science and Technology 2013**

The material in this publication is covered by the provisions of the Norwegian Copyright Act. Without any special agreement with SINTEF Academic Press and Norwegian University of Science and Technology, any copying and making available of the material is only allowed to the extent that this is permitted by law or allowed through an agreement with Kopinor, the Reproduction Rights Organisation for Norway. Any use contrary to legislation or an agreement may lead to a liability for damages and confiscation, and may be punished by fines or imprisonment.

Norwegian University of Science and Technology ²⁾

N-7491 Trondheim

Tel: +47 22 73 59 50 00

www.ntnu.no

www.zeb.no

SINTEF Building and Infrastructure Trondheim ¹⁾

Høgskoleringen 7 b, POBox 4760 Sluppen, N-7465 Trondheim

Tel: +47 22 73 59 30 00

www.sintef.no/byggforsk

www.zeb.no

SINTEF Academic Press

c/o SINTEF Building and Infrastructure Oslo

Forskningsveien 3 B, POBox 124 Blindern, N-0314 Oslo

Tel: +47 22 96 55 55, Fax: +47 22 69 94 38 and 22 96 55 08

www.sintef.no/byggforsk

www.sintefbok.no

NTNU, Faculty of Engineering Science and Technology ³⁾

Acknowledgement

This report has been written within the *Research Centre on Zero Emission Buildings (ZEB)*. The authors gratefully acknowledge the support from the Research Council of Norway, BNL – Federation of construction industries, Brødrene Dahl, ByBo, DiBK – Norwegian Building Authority, DuPont, Enova SF, Entra, Forsvarsbygg, Glava, Husbanken, Hydro Aluminium, Isola, Multiconsult, NorDan, Norsk Teknologi, Protan, Skanska, Snøhetta, Statsbygg, VELUX, Weber and YIT.

Abstract

The main aim of the work has been to do modeling and calculations of the energy use, embodied emission and the total CO₂-emissions for a typical Norwegian office building. The goal is to find the most important parameters in the design of a zero emission office building, according to the current ZEB definition.

The preliminary conclusions from this study are:

1. For a typical medium rise office building (4 storey) it is rather easy to achieve a ZEB-O (Operation) level, which in this case can be labeled a zero energy office building (energy produced on-site with PV equals total electricity demand).
2. Taking into account also the embodied emissions from materials and installations it seems very difficult to achieve the ZEB-OM (Operation and Material) level. The calculation is based on using areas with "acceptable" solar yield, namely the roof and the south (long) façade.
3. Even if the calculation of embodied emission (EE) has considerable uncertainties, preliminary results indicate that EE is considerable higher than the emission related to operational energy use. However, this is based on traditional design and material use of a Norwegian office building. A more optimized building with regard to low carbon materials, could change the balance between operational- and embodied emissions.
4. To achieve a ZEB-OM level a combination of further reduced energy demand, high performance thermal supply systems, reduced embodied emissions and increased PV-production seems to be the solution.

Contents

1.	INTRODUCTION.....	7
1.1	Background	7
1.2	Aim and scope of the work	7
1.3	About the report.....	7
1.4	Simulation tools and methods used.....	8
1.5	ZEB-definition and different ZEB- levels.....	9
2.	BUILDING MODEL.....	11
2.1	Generality, flexibility, and elasticity	11
2.2	Office occupancy	11
2.3	Material usage and design	12
3.	BUILDING ENVELOPE	19
3.1	Thermal specification of the building envelope	19
3.2	External wall	19
3.3	External roof.....	20
3.4	Floor construction	21
3.5	Windows.....	21
3.6	Thermal bridges.....	23
3.7	Heat loss budget.....	23
4.	BUILDING SERVICES	24
4.1	Ventilation system	24
4.2	Heating system.....	25
4.2.1	Air heating system	25
4.2.2	Radiator system.....	26
4.2.3	Pumps	27
4.3	Cooling system.....	28
4.4	Lights and appliances.....	29
4.4.1	Lighting system.....	29
4.4.2	Appliances.....	30
5.	ENERGY SUPPLY SYSTEM	31
5.1	Solar collector system	31
5.2	Heat pump system.....	31
5.3	Cooling system.....	32
5.4	PV-system.....	32
5.4.1	Alternative 1: Roof only.....	32
5.4.2	Alternative 2: Roof and all available south façade area	33
6.	EMBODIED ENERGY AND GREEN HOUSE GAS EMISSIONS	34
6.1	Method	34
6.1.1	Goal and scope	34
6.1.2	Functional unit	34
6.1.3	Boundaries	34
6.1.4	Electricity mix.....	35
6.2	Life cycle inventory - Using BIM	35
6.2.1	Examples of material inventory from BIM to LCA	36
6.3	Life cycle inventory – environmental data, technical installations and simplifications.....	38
6.3.1	Technical installations.....	38

6.3.2	Simplifications and uncertainty	39
6.4	Results	39
6.4.1	Carbon dioxide emissions.....	39
6.4.2	Embodied primary energy use – fossil and renewable energy.....	41
7.	ENERGY AND CO ₂ CALCULATIONS	43
7.1	Net energy budget.....	43
7.2	Splitting into electricity-specific and thermal demands	44
7.3	Thermal energy supply system.....	46
7.4	Gross delivered energy and related CO ₂ emissions	47
7.5	Embodied and total CO ₂ emissions	49
7.6	Design of on-site electricity production and total CO ₂ balance	50
7.6.1	Alternative 1: Only roof-mounted PV	50
7.6.2	Alternative 2: Roof and all available south façade used for PV	51
7.7	Mismatch in demand and production.....	52
7.7.1	Mismatch with only roof-mounted PV	52
7.7.2	Mismatch with roof and all available south façade used for PV	53
8.	INDOOR CLIMATE SIMULATIONS	54
8.1	Thermal comfort in summer.....	55
8.1.1	Office landscape	55
8.1.2	South facing office cell.....	56
8.1.3	Internal meeting room.....	57
8.2	Air quality.....	58
8.2.1	Office landscape	58
8.2.2	Office cell.....	59
8.2.3	Internal meeting room.....	60
9.	DISCUSSION, PRELIMINARY CONCLUSIONS, AND FURTHER WORK	61
9.1	Discussion	61
9.2	Preliminary conclusion.....	62
9.3	Further work	62
10.	REFERENCES.....	64

APPENDICES

1. Introduction

1.1 Background

This concept work started in late autumn 2011 with analysis of very simplified shoebox models for an office building and a residential building. The simple shoebox-models used in the development of the new passive house standard for non-residential buildings \1\ was used for the office building. In the start of 2012 it was decided to design more realistic building models. The office building was designed as a typical four storey building making a 3D-BIM model, modelled in the CAD tool Revit \2\.

1.2 Aim and scope of the work

The main aim of this work is to do realistic simulations and calculations of energy use, embodied emissions, and total CO₂-emission for a typical office building. By doing this we will try to reveal the main drivers for the CO₂-emission, and also what performance is necessary for components and solutions in a Zero Emission Building according to the current ZEB-definition, see paragraph 1.5.

1.3 About the report

Chapter 2 of this report describes the building model used in these analyses. Chapters 3-5 describe the technical solutions used for the building envelope, the building services, and the energy supply. Chapter 6 outlines the embodied emissions and embodied energy calculations, and chapter 7 treats the energy and overall CO₂-calculations. Chapter 8 deals with thermal comfort and IAQ to verify that the indoor climate is satisfactory. Chapter 9 discusses the results and gives preliminary conclusions and plans for further work.

In all calculations or simulations Oslo-climate has been used. A significant part of the existing and future Norwegian building stock are situated in climate much colder than Oslo, giving raise to much higher heating demand than in Oslo climate. In addition, and often more important, more northern and/or more cloudy climates compared to Oslo, will also have a large drawback in using solar energy for solar thermal collectors and PV. Even if such climates will have lower or no cooling demand, it is quite clear that such climates will be more challenging in meeting the different ZEB-levels.

In some cases two or three alternatives are evaluated/calculated, but no real sensitivity analysis has been done. This will be further elaborated in the continuing concept work.

ZEB-Design

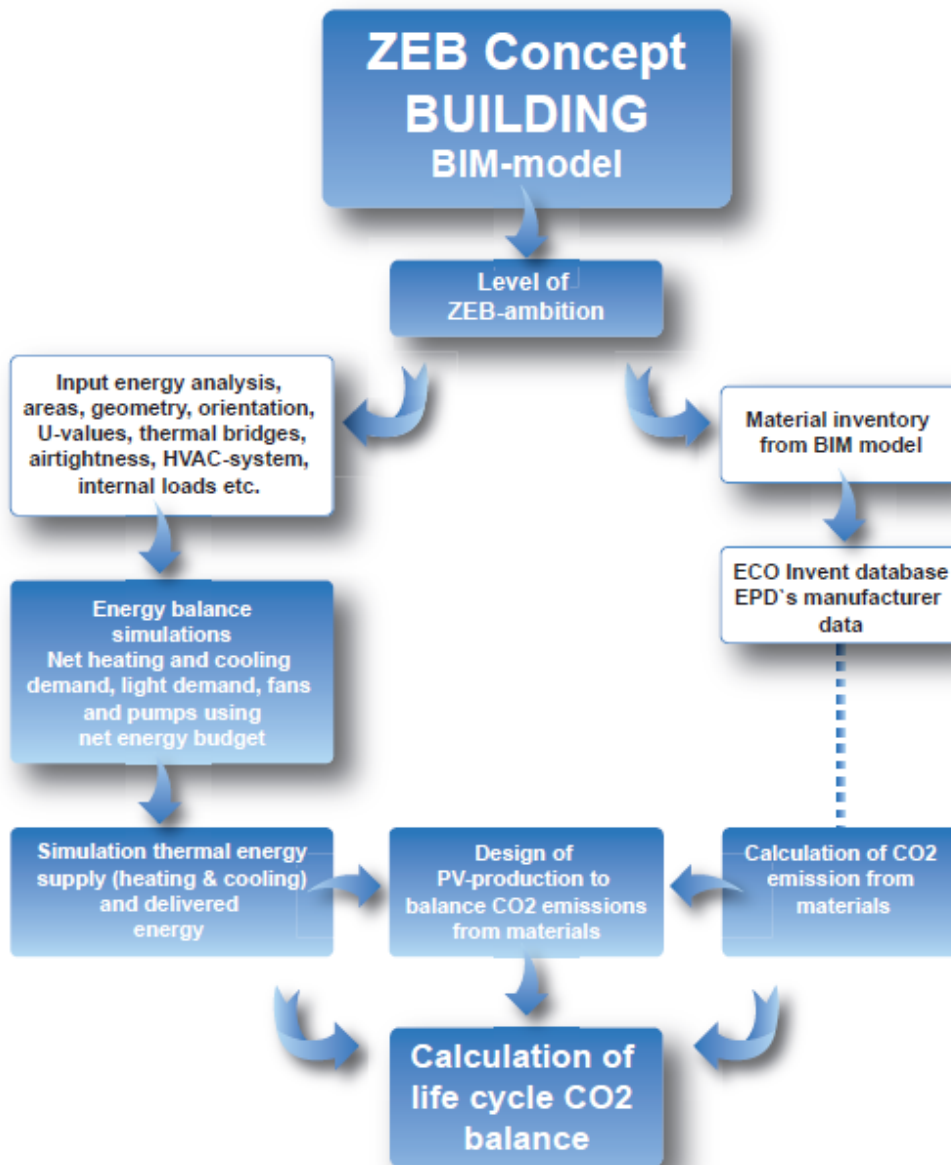

Figure 1.1 The work flow used during the ZEB concept work.

1.4 Simulation tools and methods used

The architectural drawings are based on a 3D BIM (building information model) carried out using Revit Architecture Suite version 2011 \2).

Embodied emission and embodied energy calculation have been carried out with the LCA Software tool SimaPro version 7.3.0 \3) and data from the LCA database Ecolnvent version 2.2 \4). Material inventories have been exported from the Revit BIM using Excel. The method of classification are all based on the Norwegian standard NS 3455, which is one in a series of Norwegian Standards, structuring information related to building construction. The classification forms a basis for a complete

description of a building assessed by function. P 336 is a corresponding guide featuring how to use the standard.

Simulation of annual heating and cooling demand, peak heating and cooling load, net energy budget, delivered energy, heat loss calculation, thermal comfort simulation and CO₂-level simulation have been done in SIMIEN version 5.011 \5\.

Calculation of the performance of the solar collector system has been done with the F-chart method \6\ and has been verified by simulation in PolySun \7\. Heat pump calculation has been done by simple spread sheet models in MS Excel, but also verified by simulations in PolySun \7\.

The performance of the PV systems has been calculated with simplified spread sheet models (Excel), but is verified by the PV-tool PV-syst \8\.

1.5 ZEB-definition and different ZEB- levels

At present a revised definition of ZEB is being prepared. The current definition is based on nine criteria:

1. Ambition level
2. Basis for calculation
3. System boundaries
4. CO₂-factors
5. Energy quality
6. Mismatch, production and demand
7. Minimum requirements, energy efficiency
8. Requirements, indoor climate
9. Verification in use

We will not go into detail about these criteria, apart from saying something about the ambition levels currently defined. Figure 1.2 illustrates how the different levels take into account different emission items. The four levels are at the moment defined as:

1. ZEB-O÷EQ: Emissions related to all energy use except the energy use for equipment (appliances) shall be zero. Energy use for equipment is often regarded as most user dependent and is difficult to design for low energy use.
2. ZEB-O: Emission related to all operational energy use shall be zero, also energy use for equipment.
3. ZEB-OM: Emissions related to all energy used for operation plus all embodied emissions from materials and installations shall be zero. ***This is the level we aim to achieve in this study.***
4. ZEB-COM: Same as ZEB-OM, but also taking into account emissions related to the construction process. At the moment we do not have the data and methods to quantify these emissions in an accurate way.

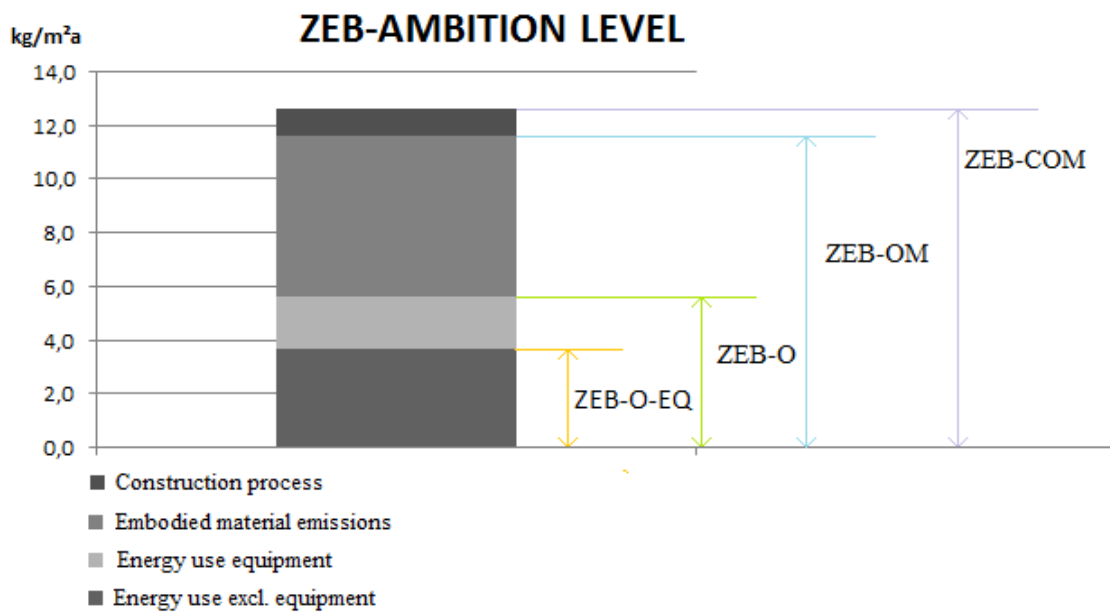

Figure 1.2 Different ZEB ambition levels in the current ZEB-definition.

2. Building model

The concept building is a 4 storey high office building plus a basement. The basement, used for technical rooms and parking, is unheated and not included in the heat floor area (BRA), although included in the material emission analysis. The HVAC system is placed in the basement while the air intake is situated on the roof. The rectangular footprint of the building is approximately 17 x 30 meters, with long facades facing south and north. The building contains a typical mix of office cells and open plan offices, as well as associated rooms, such as meeting rooms, common spaces and a larger meeting room situated on the fourth floor. This also serves as a canteen for the employees.

Each floor has a heated floor area (BRA) of 495 m², giving a total area of 1980 m² BRA. The total window and door area is 456 m², which gives a window/door to floor area ratio of 23 %. This is a typical ratio for office buildings, and the window and door area constitutes 35 % of the (vertical) façade area.

2.1 Generality, flexibility, and elasticity

The building is based on a general structure that does not impose restrictions on the floor plan and that meets the client's and user wishes at the time of completion but also wishes in having the possibility of frequent changes over time (9). The circulation areas are planned in a manner that minimizes the disturbing movement within the workspace, thus reducing noise in the open plan office spaces. The structure and fittings are designed for a high level of flexibility. Dismantling, removal, and installation of partitions are easy to manage without extensive demolition and construction work and without having to make large electrical and/or mechanical reconstructions.

The office areas are suitable both for open floor plans and/or office cells, or a combination thereof. Internal changes can be implemented by easy removal or addition of partitions. The building's overall technical infrastructure also allows for such flexibility.

The main staircase and elevator is placed in such a way that it contributes to increased flexibility providing efficient communication between floors.

2.2 Office occupancy

The office area is adaptable for various solutions, thus the number of office work spaces will vary correspondingly. The example used is a typical mix of prime office area disposed between cellular offices and open office spaces with individual and team places. Secondary areas include corridors, stairs, WC, copy room, and common areas.

Table 2.1 Typical work spaces, divided in cellular offices and open office spaces.

Floor	No. of work spaces	No of cellular offices	Open office spaces
1 st floor	33	13	20
2 nd floor	33	13	20
3 ^d floor	33	13	20
4 th floor	14	14	0
Whole building	113	53	60

The office building is designed following current Norwegian building codes. Work zones have a minimum ceiling height of 2700 mm with a total height between slabs measuring 3600 mm.

2.3 Material usage and design

For materials used in the external walls, roof and main construction, see sections 3.2-3.4. A cement fibre board is used for façade cladding. PV panels and solar thermal collectors are used as building integrated elements on the south facade (see illustrations in chapter 5.). An acoustic ceiling (covering part of the ceiling to allow for thermal mass), a flooring material covering the whole floor area, and the use of non loadbearing walls are all features allowing for a high degree of flexibility. The life cycle inventory described in section 6.3 shows a detailed list of materials used.

Figures 2.1 to 2.12 present perspective, facades, floor plans, and sections of the building.

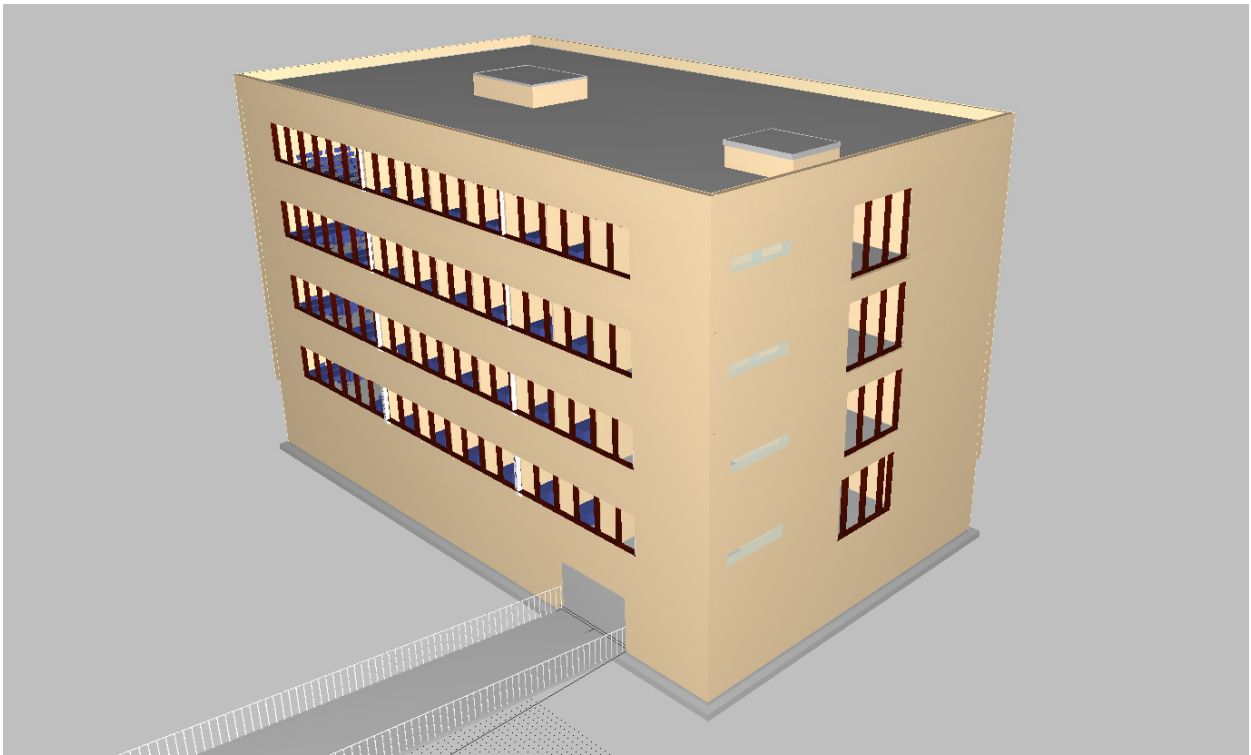

Figure 2.1 Perspective of the office building.

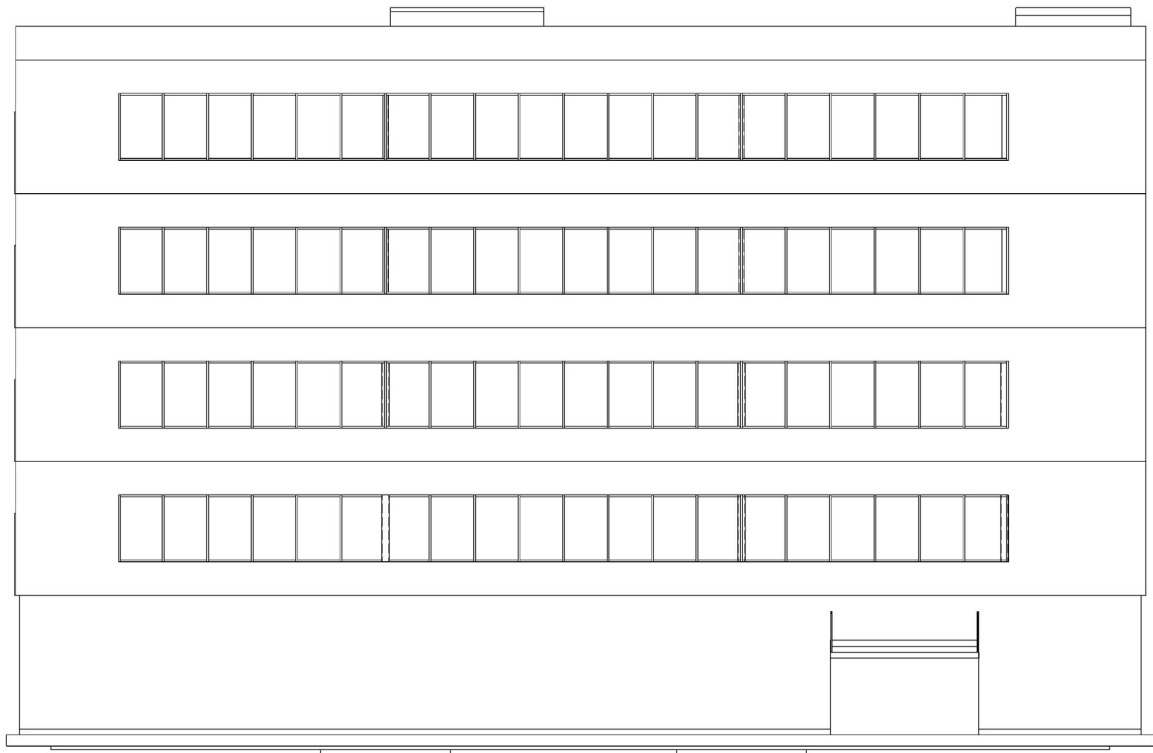

Figure 2.2 North façade.



Figure 2.3 East façade.



Figure 2.4 West façade.

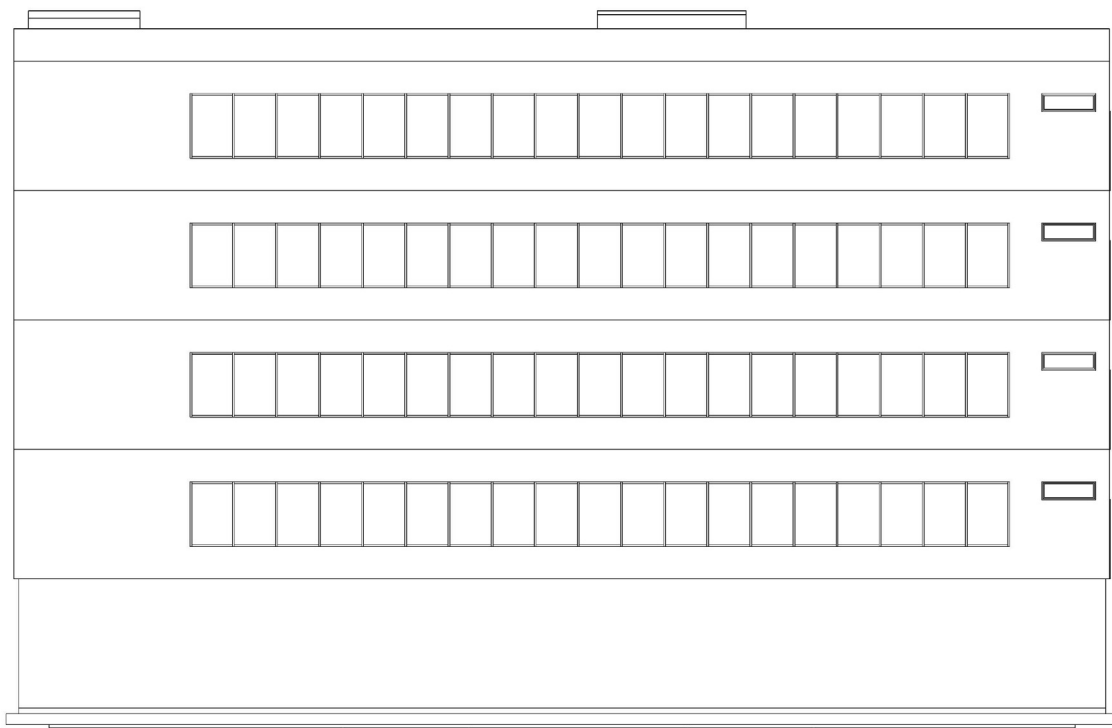

Figure 2.5 South façade.

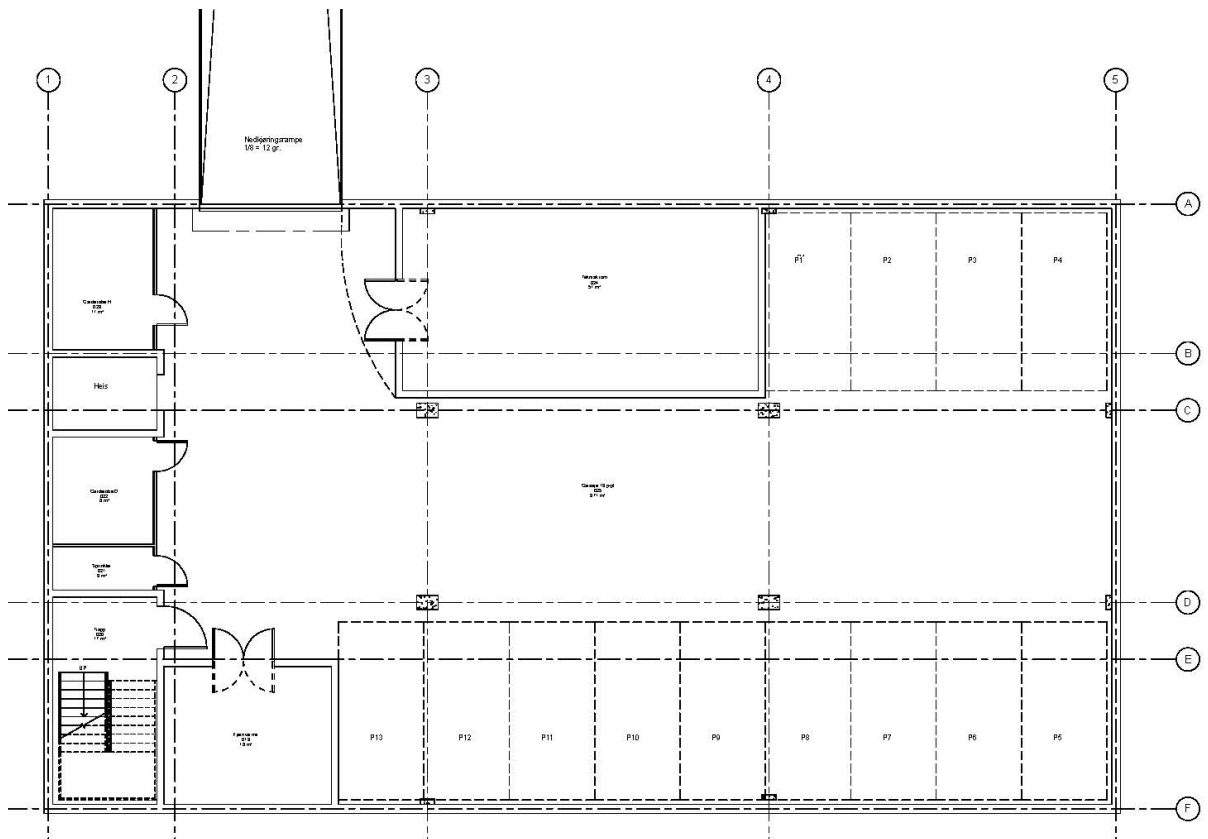

Figure 2.6 Floor plan cellar.

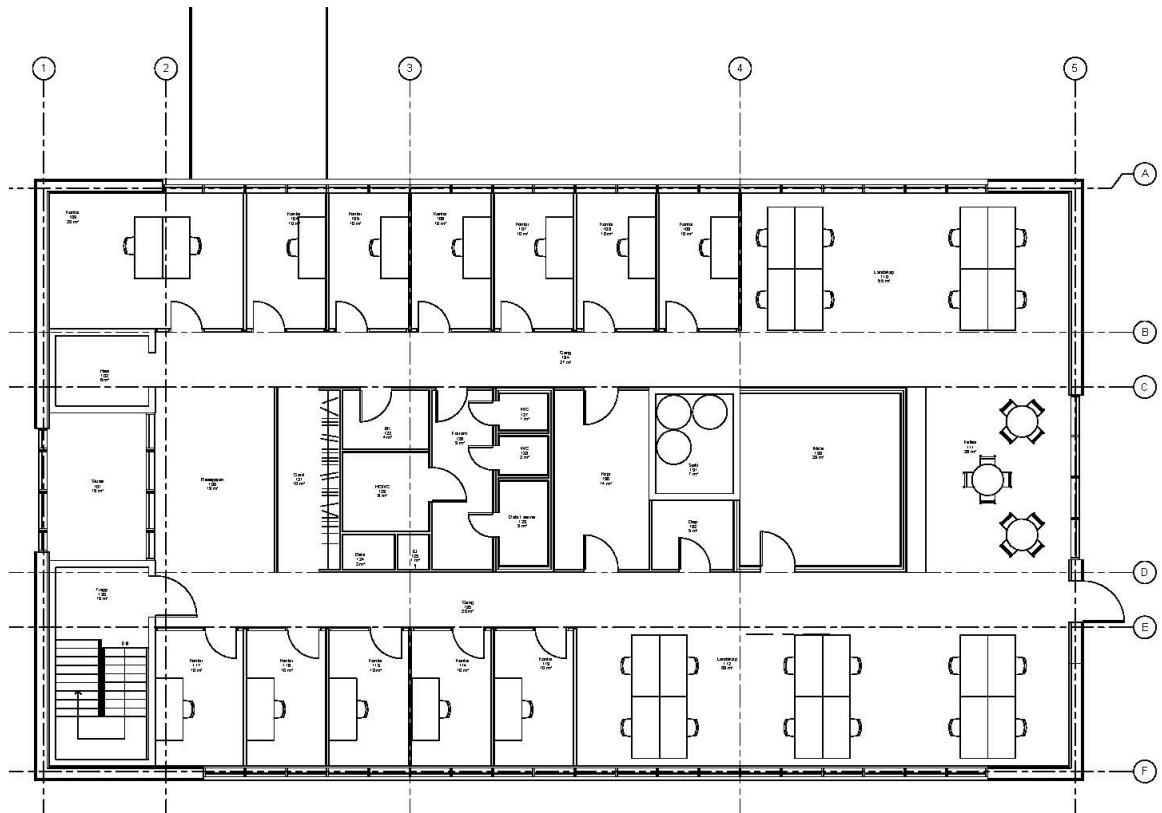

Figure 2.7 Floor plan 1st floor.

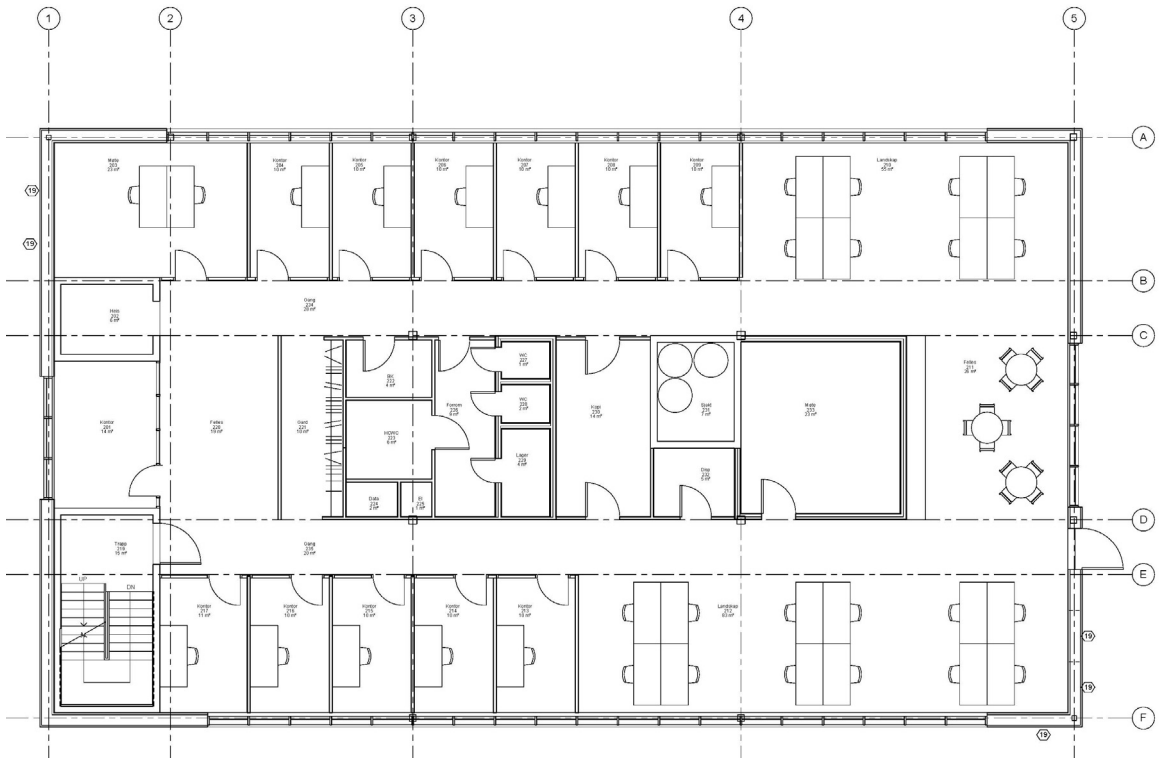

Figure 2.8 Floor plan 2nd floor.

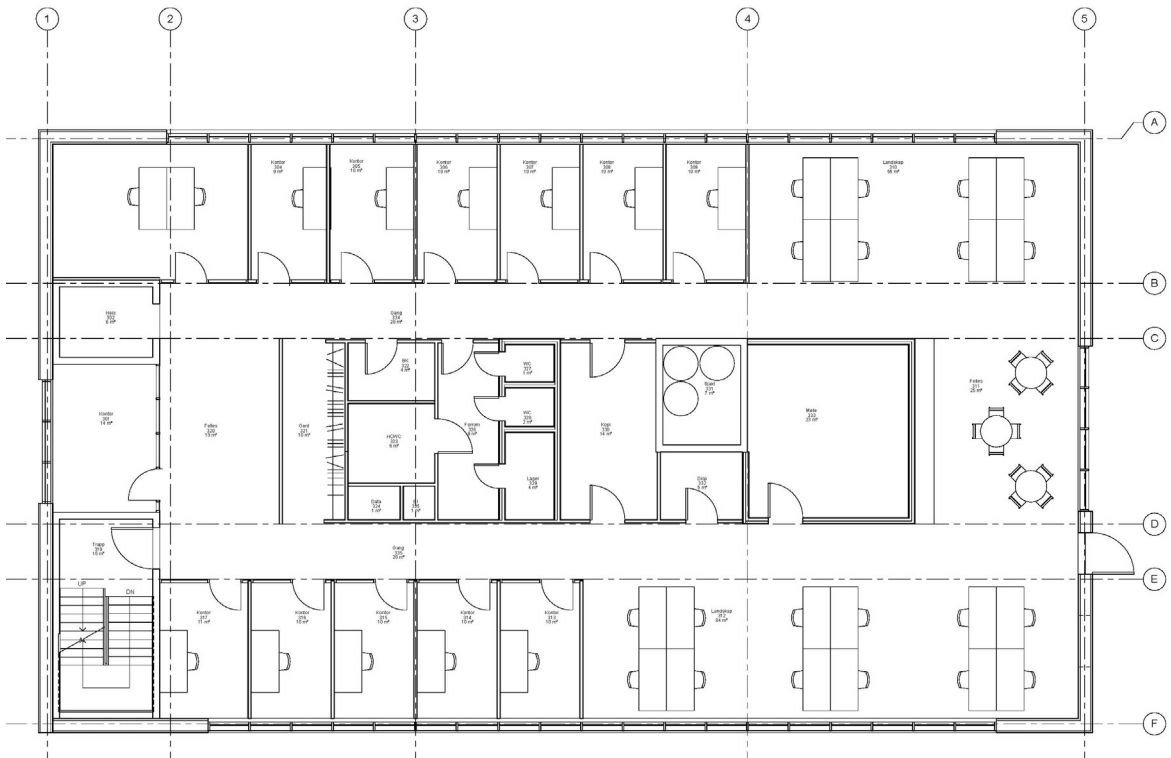

Figure 2.9 Floor plan 3rd floor.

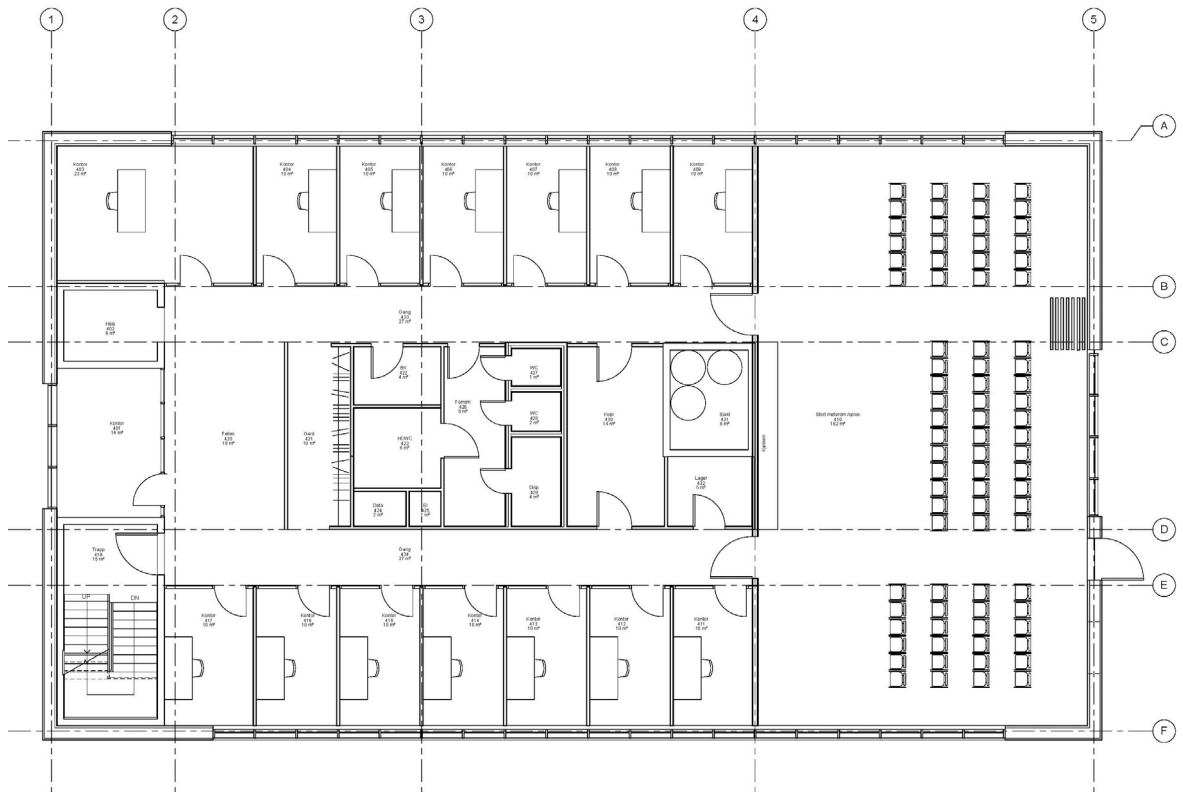

Figure 2.10 Floor plan 4th floor.

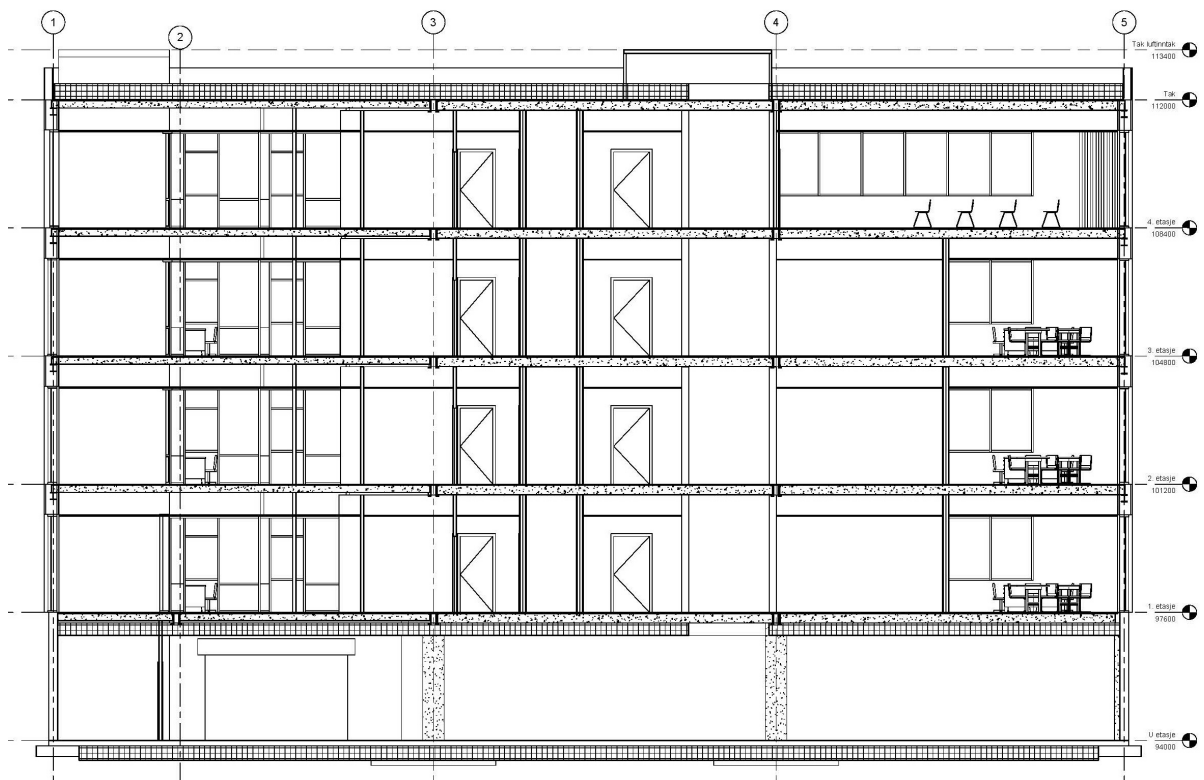

Figure 2.11 Section A-A.

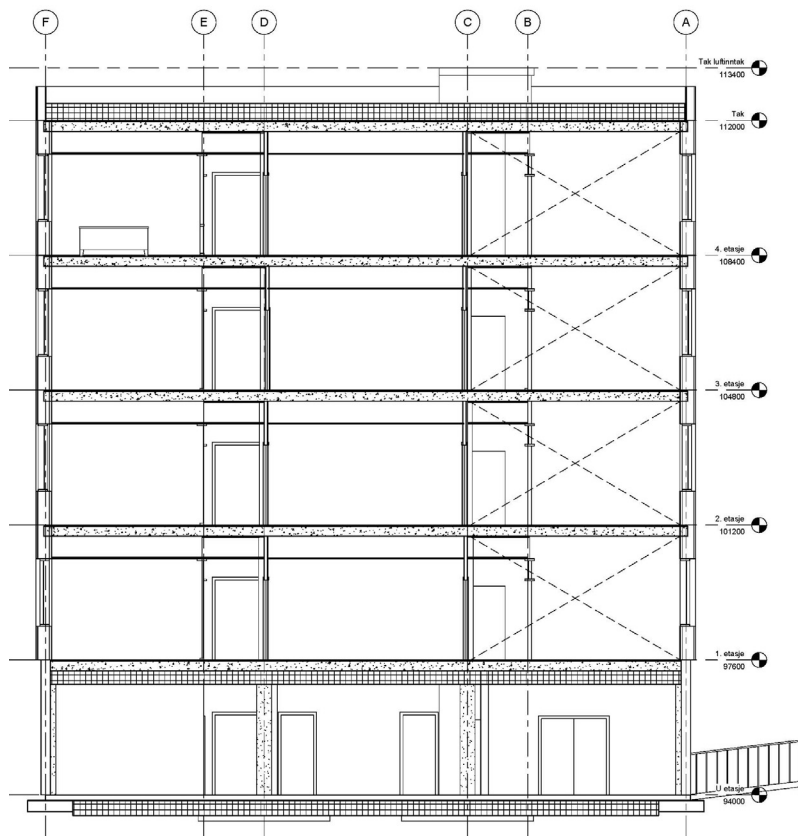

Figure 2.12 Section B-B.

3. Building envelope

3.1 Thermal specification of the building envelope

The office building has a very traditional loadbearing structure with concrete slabs supported by steel beams and columns/pillars. The building envelope is placed on the outside of the loadbearing system. Table 3.1 gives the thermal specification of the building envelope. Even though this is a high performance building envelope, these numbers can be achieved by materials and solutions already on the market in 2012.

Table 3.1 Specifications for the building envelope.

	Values	Solution
External walls	$U = 0.12 \text{ W/m}^2\text{K}$	Timber frame wall with 350 mm insulation.
External roof	$U = 0.09 \text{ W/m}^2\text{K}$	Compact roof with approximately 450 mm insulation.
Floor against cellar*	$U = 0.11 \text{ W/m}^2\text{K}$	Floor construction with 350 mm insulation, facing unheated basement.
Windows	$U = 0.75 \text{ W/m}^2\text{K}$	Three pane low energy windows, with insulated frame.
Doors	$U = 0.75 \text{ W/m}^2\text{K}$	Passive house door solutions.
Normalized thermal bridge value	$\psi'' = 0.03 \text{ W/m}^2\text{K}$	Detailed thermal bridge design
Air tightness	$N50 < 0.3 \text{ ach}@50 \text{ Pa}$	Detailed design of a continuous vapour and wind barrier, good quality assurance in craftsmanship and pressure testing of the building in two stages (when the wind barrier is mounted and when the building is finished).
Heat loss factor cellar	0,78	Taking into account the increased thermal resistance of the unheated basement

* U-value taking into account the heat loss factor (b) of the unheated basement

3.2 External wall

A well insulated timber frame wall constructed as shown in Figure 3.1 has been used in the design. This construction gives a U-value of $0.12 \text{ W/m}^2\text{K}$.

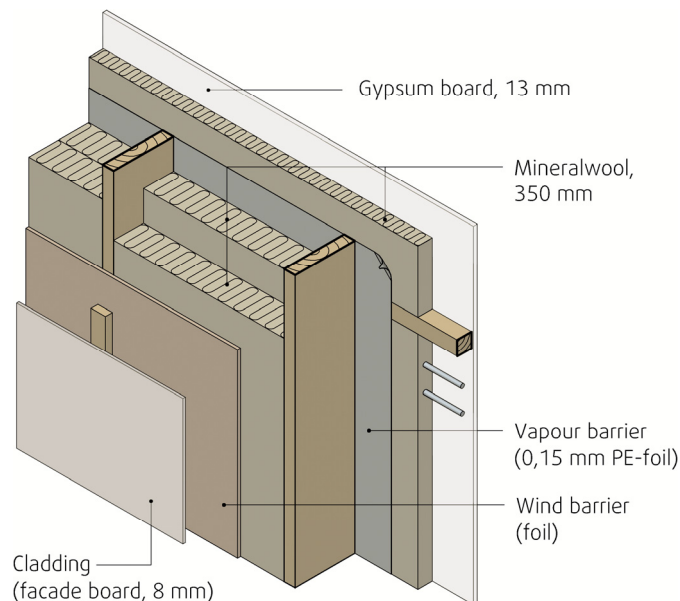

Figure 3.1 Principle section of the external wall.

Different wooden wall constructions can achieve a U-value of 0.12 W/m²K. Figure 3.2 shows the necessary insulation thickness for different wooden walls reaching a U-value of 0.12 W/m²K with an insulation material with a conductivity of 0.033 W/mK.

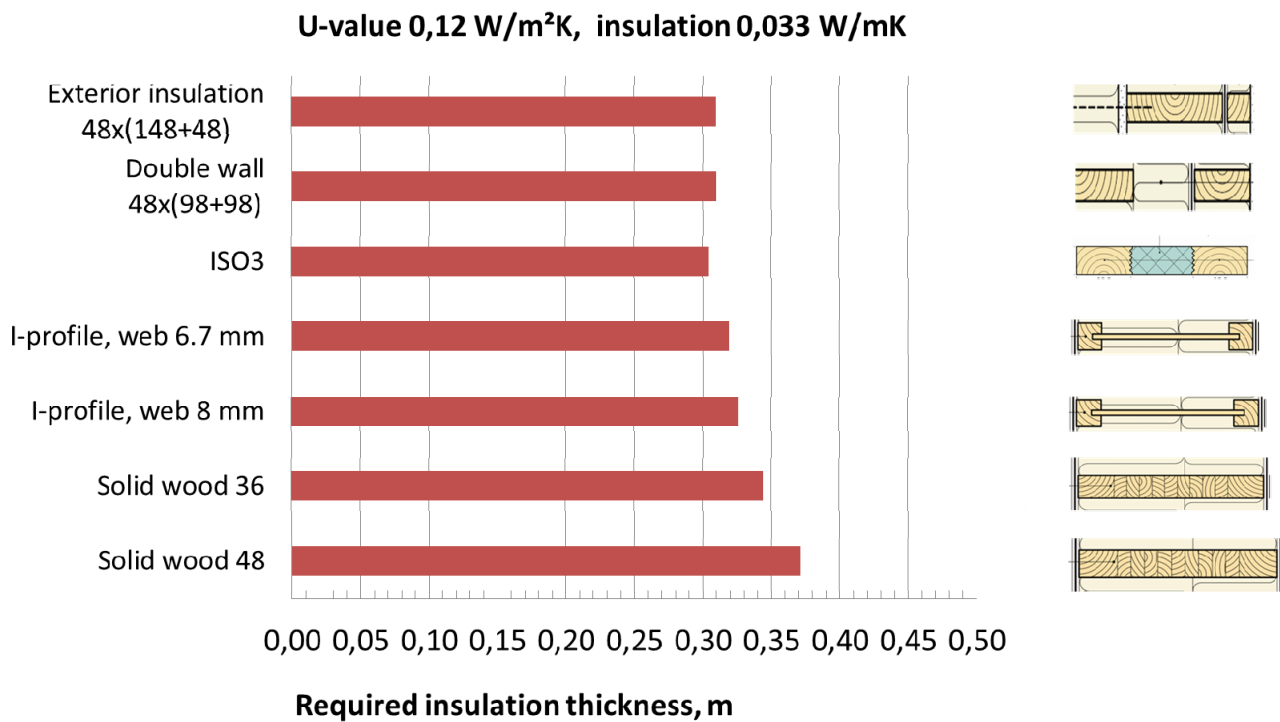

Figure 3.2 Necessary insulation thickness for different wooden walls reaching a U-value of 0.12 W/m²K with an insulation material with a thermal conductivity of 0.033 W/mK. From Uvsløkk et al., \10\.

3.3 External roof

The roof is built as a well insulated compact roof construction upon a concrete slab. 450 mm insulation with U-value of 0.09 W/m²K is applied. The roof construction is shown in Figure 3.3.

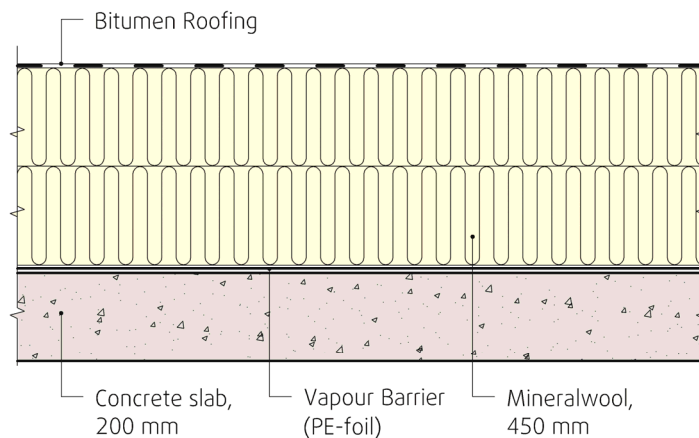

Figure 3.3 Principle section of the external roof.

Different roof constructions achieving a U-value in the range 0.09-0.10 W/m²K can be used. Figure 3.4 shows the necessary insulation thickness for some different roof constructions reaching a U-value of 0.10 W/m²K with an insulation material with a conductivity of 0.033 W/mK.

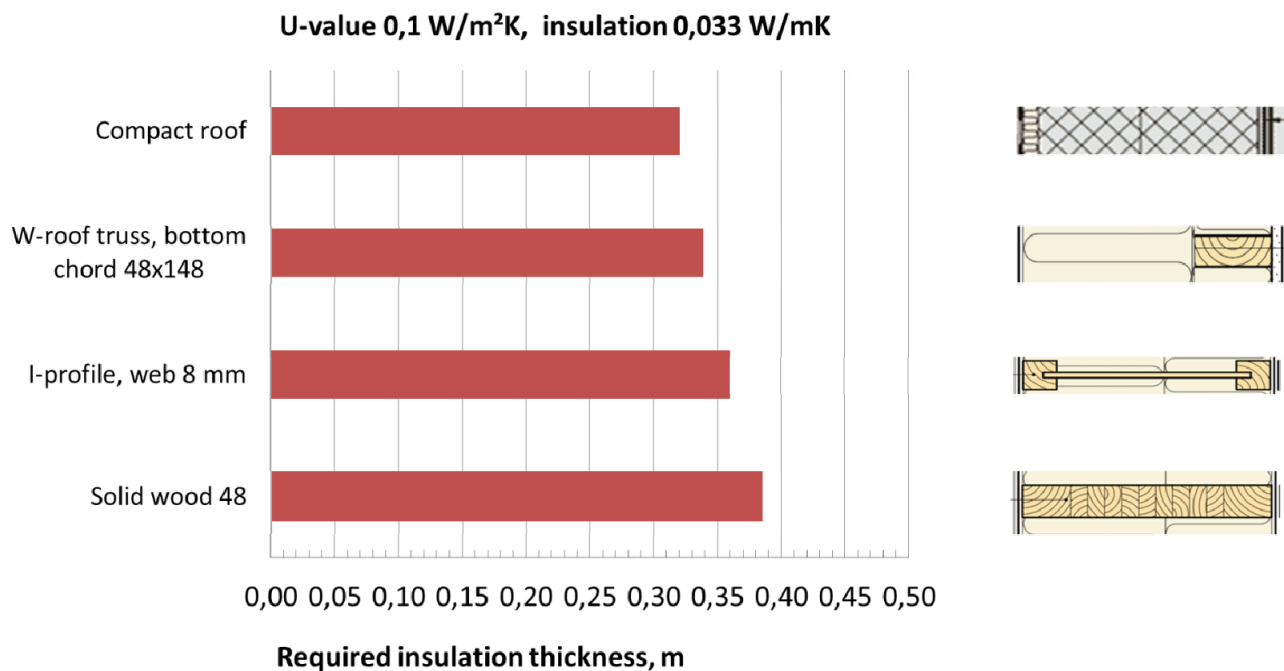

Figure 3.4 Necessary insulation thickness for different roof constructions reaching a U-value of 0.10 W/m²K with an insulation material with a conductivity of 0.033 W/mK. From Uvsløkk et al. \10\.

3.4 Floor construction

The floor against the unheated basement of the building consists of a construction insulated with 300 mm insulation, giving a U-value of 0.14 W/m²K. The floor construction is insulated with 100 mm below the concrete slab and 200 mm above the slab. The heat loss factor (b) for the unheated basement is calculated to be 0.78 according to NS3031 \11\). The effective U-value for the floor construction then becomes: $U_{fi} = 0.78 \times 0.14 = 0.11$ W/m²K.

3.5 Windows

Three-pane aluminium windows with insulated frame and sash are applied. The mean U-value of the windows is 0.75 W/m²K. The g-value of the windows is 0.51. The windows are positioned in the middle of the wall in order to reduce the thermal bridge effect, see Figures 3.5 and 3.6.

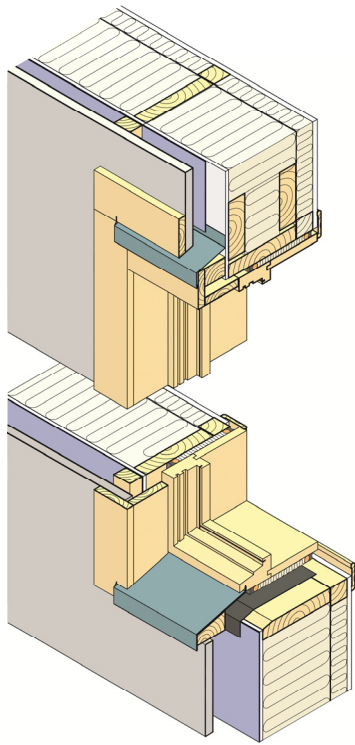

Figure 3.5 Sketch showing an optimal position of a window regarding thermal performance. It is positioned in the middle of the wall in order to reduce the thermal bridge effect. From \12).

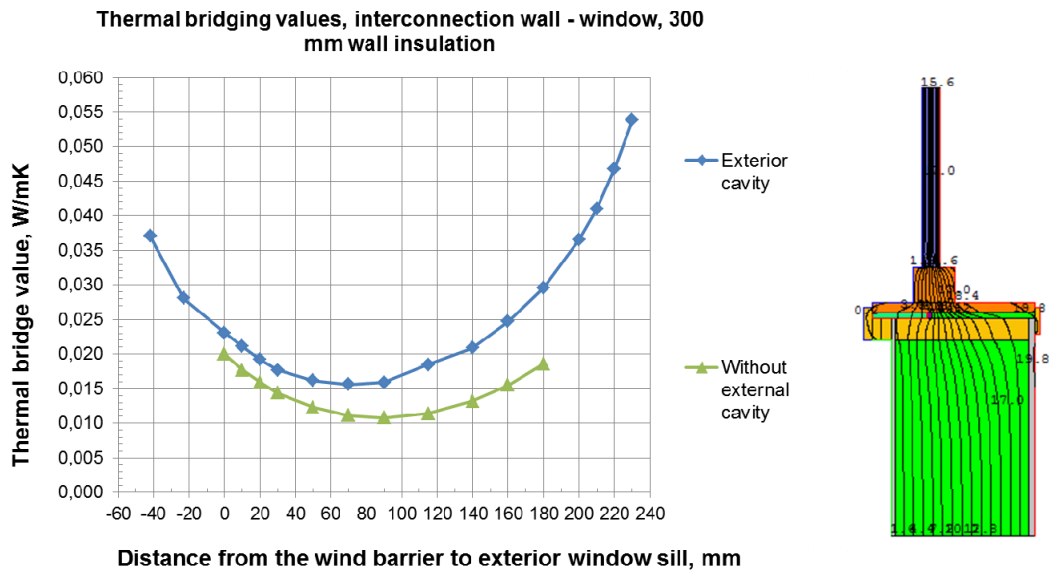

Figure 3.6 The graph shows calculated thermal bridge values (y-axis), depending on the position of the window, given as the distance between the outer window frame and the exterior sheathing. From Uvsløkk et al. \10).

3.6 Thermal bridges

The heat loss due to thermal bridges is set to be in accordance with the requirements in the Norwegian passive house standard NS 3701: 2010 (0.03 W/m²K) as the normalized thermal bridge value according to NS 3031:2007. Best practice principles in detailing have to be applied. The insulation should primarily be on the outside of the loadbearing structure to reduce thermal bridges to a minimum. Windows should be positioned towards the middle of the wall. Table 3.2 gives a rough estimate of the thermal bridge losses for the building. Thermal bridge values are primarily taken from Gustavsen et al. \13\). All details for the junctions have not been detailed in this phase of the concept work, and the thermal bridge heat loss budget is therefore only indicative. Based on the estimated heat loss in Table 3.2, the normalized thermal bridge value becomes: $\psi = 49.3/1980 = 0.025 \text{ W/m}^2\text{K}$. Due to the uncertainty in the calculation this value is rounded off to 0.03 W/m²K.

Table 3.2 Thermal bridge heat loss for the building.

Thermal bridge	Thermal bridge value	Length	Heat loss
Wall-floor junction	0.05 W/mK	94 m	4.7 W/K
Concrete floor-external wall	0.05 W/mK	282 m	14.1 W/K
Wall-roof junctions	0.05 W/mK	94 m	4.7 W/K
Window perimeter	0.015 W/mK	566 m	8.5 W/K
Door perimeter	0.02 W/mK	24 m	0.5 W/K
Corners	0.04 W/mK	56 m	2.2 W/K
Steel columns	0.04 W/mK	280 m	11.2 W/K
Beams in basement	0.05 W/mK	68 m	3.4 W/K
SUM	-	-	49.3 W/K

3.7 Heat loss budget

The passive house standard for non-residential buildings NS3701: 2012 \1\ sets a minimum requirement for the heat loss number for transmission- and infiltration heat losses to 0.40 W/m²K for office buildings. The heat loss number is the specific heat loss for transmission- and infiltration (W/K) divided by the heated floor area for the building, as defined in NS3031 \11\ This is also proposed as one of the minimum requirements for energy efficiency for ZEB-buildings, see paragraph 1.5. As shown in Table 3.3, the heat loss number for transmission and infiltration heat losses for the ZEB concept office building is well below this requirement.

Table 3.3 Calculation of the heat loss numbers for the building.

Item	Heat loss number
Heat loss external walls	0.05 W/m ² K
Heat loss roof	0.02 W/m ² K
Heat loss floor (towards cellar)	0.03 W/m ² K
Heat loss windows and doors	0.17 W/m ² K
Heat loss thermal bridges	0.03 W/m ² K
Heat loss infiltration	0.02 W/m ² K
Total heat loss number transmission and infiltration	0.33 W/m ² K

4. Building services

The main idea behind the concept is to reduce the ventilation, cooling and heating demand to such an extent that the HVAC system can be significantly simplified without compromising on indoor comfort.

Table 4.1 Specification for the HVAC installations.

	Values	Technical solution
Heat recovery	$\eta = 86 \%$	Rotary wheel heat exchanger.
Specific fan power	SFP = 1,0 kW/(m ³ /s)	Low pressure air handling unit (AHU) and low pressure ducting system.
Installed cooling capacity	$Q''_{cool} = 10 \text{ W/m}^2$	Low installed capacity, so it can be run as free cooling (just circulation pumps) based on bore holes.
Installed heating capacity, alternative 1	$Q''_{heat} = 30 \text{ W/m}^2$	Installed capacity to preheat supply air, so no room heating is needed.
Installed heating capacity, alternative 2	$Q''_{heat} = 15 \text{ W/m}^2$	Installed capacity for hydronic radiators.

4.1 Ventilation system

The air handling unit is situated in the unheated basement (a well insulated technical room is designated for this), which is equipped with a high efficiency rotary wheel exchanger. An optimized solution with low velocity and large depth of the rotary wheel gives a temperature efficiency of 86 %. To reduce the pressure loss a combined coil for both heating and cooling in the AHU is used. This also guarantees that heating and cooling cannot be supplied to the building at the same time, something which often is the case for conventional office buildings with heating and cooling, see \14\.

Even if the average air flow rate is rather low (see Table 3.2) the AHU(fans) has a capacity of up to 12 m³/hm², which is the average number for the building, while meeting rooms and canteen/auditorium will have capacities up to 18 m³/hm². This rather high capacity (compared to average figures) makes it possible to have forced ventilation when needed and also provides capacity for night cooling when needed in summer.

A low pressure ducting system is planned, where the maximum air velocity (for average air flow rates) is kept below 1.5 m/s. This ensures a low fan power, estimated to be around 1.0 kW/(m³/s) for the average air flow rate given in Table 4.2. It also ensures a low noise level.

The air is supplied as mixing ventilation with air supply devices that can handle over- and under temperature (both heating and cooling), and also with a large variety in air flow rates.

Air flow rates are demand controlled (VAV), based on CO₂ levels, temperature, and presence sensors. CO₂ sensors are used in the open plan offices, meeting rooms, and auditorium/canteen, and presence sensors in office cells and other small rooms. The VAV-system is equipped with a so-called optimizer that ensures that dampers and fans are optimally controlled for low energy use, see e.g.\15\.

Table 4.2 shows how the air flow rate used in the simulations is calculated. The estimated air flow rates in hours of operation (12 hours each working day) in the heating season is 5.5 m³/hm², and 0.7 m³/hm² outside hours of operation. The air flow rate is raised in the cooling season (May-August) to approximately 7.0 m³/hm² in hours of operation. Assumptions about primary and secondary occupation, presence in hours of operation, etc. are taken from Dokka \16\.

Table 4.2 Calculated air flow rates used in simulations.

	Value	Comment
Primary area occupation	65 %	Office cells, open plan offices, meeting rooms, etc, where the primary function of the building are.
Secondary area occupation	35 %	Corridors, stairs, WC, copy room, rooms/areas with brief occupation.
Area per person in primary area	5 m ²	An average number for office cells, open plan offices and meeting rooms.
Air flow rate per person	25 m ³ /h	Equals 7 l/s, according to the Norwegian building code.
Air flow rate materials	2.52 m ³ /hm ²	Equals 0,7 l/sm ² according to the Norwegian building code.
Presence in the hours of operation (12 hours/day)	60 %	I.e. an office cell or a meeting room will be used 7,2 hours in a normal working day. This is probably an
Air flow rate primary area, with presence	$25/5 + 2.5 = 7.5 \text{ m}^3/\text{hm}^2$	Average air flow rate when persons are present in primary areas.
Air flow rate primary area, average in hours of operation	$7.5 \cdot 0.6 + 0.4 \cdot 2.5 = 5.5 \text{ m}^3/\text{hm}^2$	Average air flow rate in hours of operation (12 h) in primary areas (for air quality).
Average air flow rate in primary and secondary areas, hours of operation	$5.5 \cdot 0.65 + 2.5 \cdot 0.35 = 4.5 \text{ m}^3/\text{hm}^2$	Average air flow rate in hours of operation (12 h) in all areas (for air quality).
Additional air flow rate for heating and cooling	1.0 m ³ /hm ²	Estimated extra air flow rate for using the supply air for cooling and heating purposes
Air flow rate in hours of operation, heating season (1 Sept – 1 May)	$4.5 + 1.0 = 5.5 \text{ m}^3/\text{hm}^2$	Value used in simulation, heating season
Air flow rate in hours of operation, cooling season (1 May-31 Aug)	7.0 m³/hm²	Value used in simulation, cooling season
Air flow rate outside hours of operation	0.7 m³/hm²	Assuming that the air flow rate on average extends 1 hour extra each night* and starting two hours before normal hours of operation ("flushing" before people come to work).

* Due to people working long hours in parts of the building.

4.2 Heating system

Two separate heating system solutions have been evaluated for this building:

1. An air heating system using the balanced ventilation system as distribution system. This simplifies the heating system drastically, leading to a potential cost reduction.
2. A more conventional hydronic radiator system. This can also be greatly simplified due to low power demand and the well insulated windows with no down draft risk.

4.2.1 Air heating system

This simplified heating system uses the supply air as distribution system. The supply air heating system can be globally controlled by the supply temperature and "night heating". By "night heating" we mean the supply air has a temperature a few degrees (2-10 degrees) above the room air temperature and is supplied at night (no occupation). This eliminates one of the drawbacks with using air for heating purposes (warm air is perceived less fresh than cold air). The supply temperature and air flow rate can then be controlled by the extract temperature which can be regarded as an average indoor temperature for the building. Figure 4.1 gives the simulated indoor temperature and supply temperature for the whole building (modeled as one zone) for winter design conditions (Oslo). The air flow rate during the night is set to 6 m³/hm² with a supply temperature of 27 °C, but is reduced to 4.5 m³/hm² with a supply

temperature of 19 °C during day time to meet the air quality requirements. This "night heating" strategy seems to work satisfactory globally for the whole building, but has to be analyzed more in depth on a room/zone level. The necessary installed capacity of the heating coil to achieve the wanted "night heating" effect is 30 W/m² (59.4 kW).

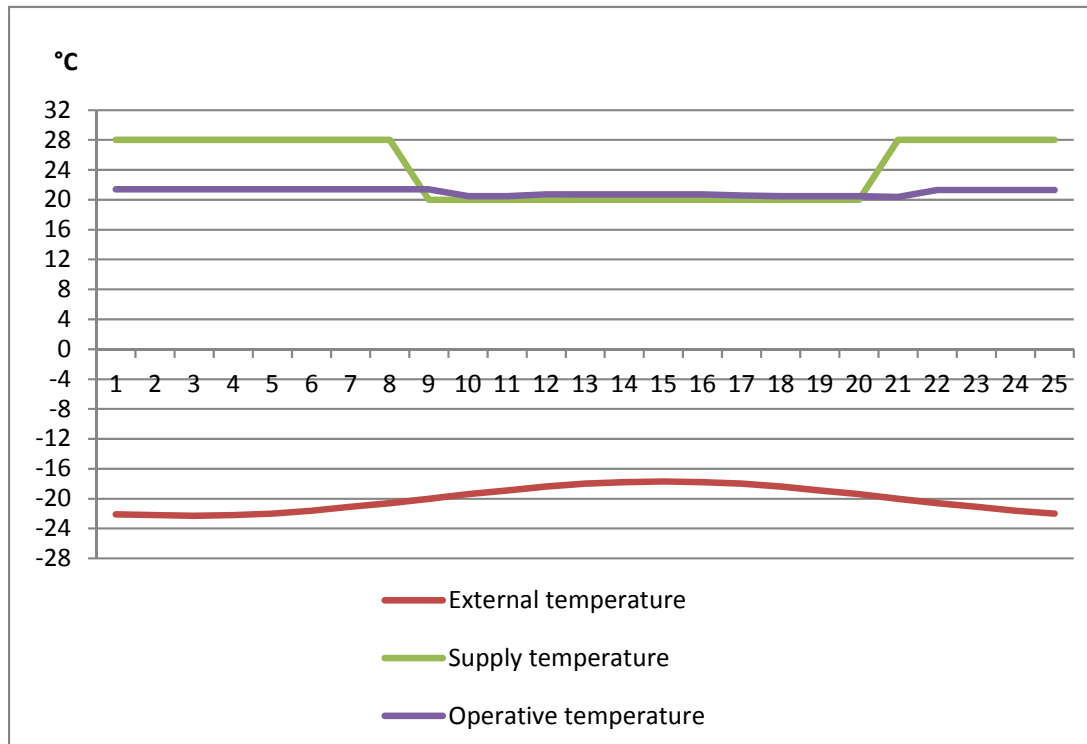

Figure 4.1 Simulated operative temperature and supply temperature for the whole building under design winter conditions, using the supply air system for heating the building.

4.2.2 Radiator system

An alternative solution is to use hydronic radiators. Radiators in each room can then be controlled individually. If the system is designed to keep a constant indoor temperature of 21 °C (no intermittent heating) at design winter condition, an installed capacity of 15 W/m² (29.7 kW) is needed.

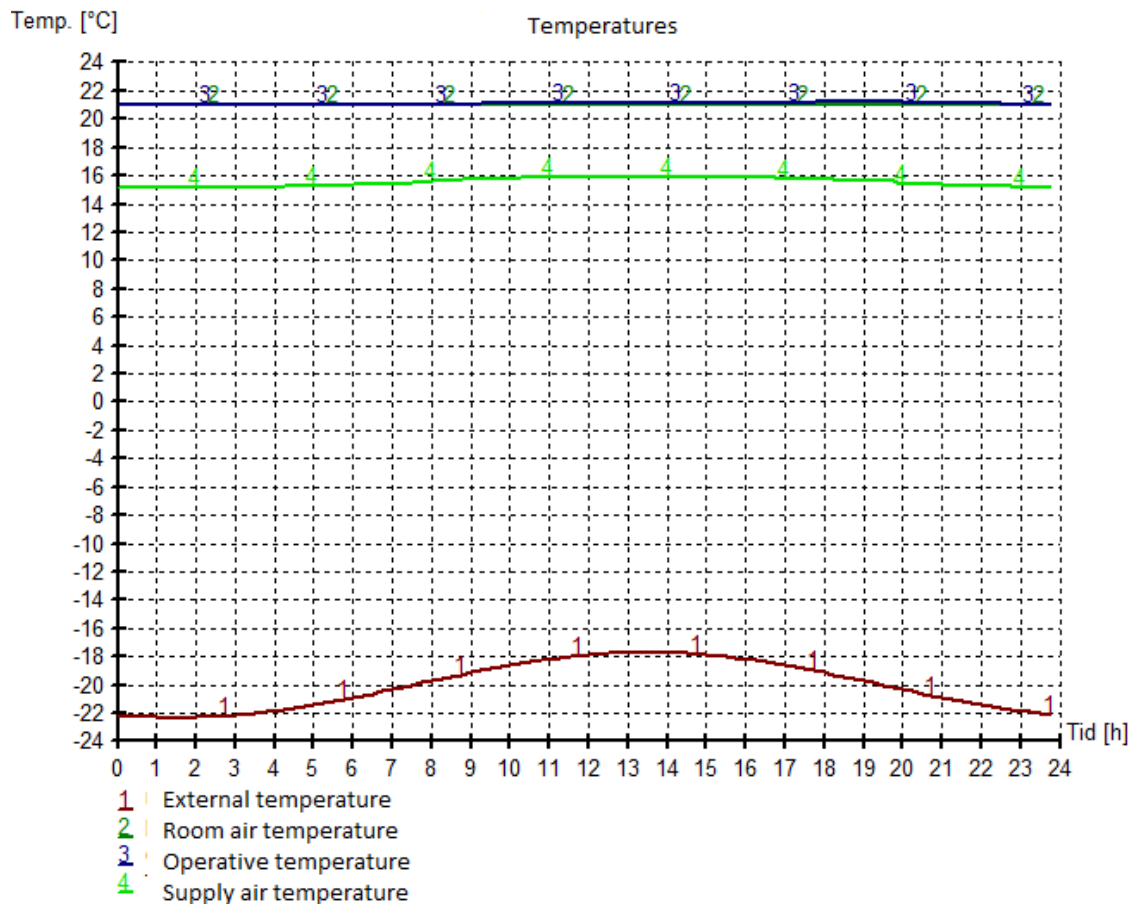

Figure 4.2 Simulated temperatures for the whole building under design winter conditions, using hydronic radiators for heating the building.

4.2.3 Pumps

A variable flow control system is assumed for the heating system, adjusting the flow in the hydronic system according to the heat demand. The maximum flow in the system is calculated:

$$M = 1000 * Q / (\Delta T * C_p * \rho) = 1000 * 15 * 1980 / (10 * 4180 * 988) = 0,72 \text{ l/s.}$$

Q: Design heat load, here 15 W/m² (assumed radiators), multiplied by heated floor area

ΔT: Temperature difference between inlet and return in the hydronic system

C : Heat capacity of water, 4180 J/kgK

ρ: Density of water kg/m³, 988 kg/m³

According to NS3031 \11\, appendix I, a default specific pump power factor (SPP) for a constant volume heating system is 0.5 kW/(l/s). With a good variable volume flow system, we have assumed a SPP value of 0.3 kW/(l/s). According to the SIMIEN simulation of the building the hours of operation of the heating system is close to 2200 hours in a normal year.

Calculating the pump energy conservatively as a constant volume system gives:

$$E = \text{SPP} * M * 2400 = 518 \text{ kWh/a} = 0.26 \text{ kWh/m}^2\text{a.}$$

In other words the energy used for pumps in the heating system is very small, even when conservative calculations are applied. The air heating system would use slightly more energy for pumps, due to the higher peak heating load, but would still be very small compared to e.g. fans in the ventilation system.

4.3 Cooling system

A centralized cooling system (in the AHU) using the supply air for cooling is applied. A modest capacity of 10 W/m² is enough to keep the indoor temperature comfortable under design summer condition. In the hottest periods a supply set point of 16 °C is used, but this will drift up to ca. 23 °C during the hottest days due to the limited capacity. Figure 4.3 shows the temperature simulated for the whole building (as one zone). An average constant (diurnal) air flow rate of 7m³/hm² is applied, but can be raised further towards 12m³/hm² if necessary. Figure 4.4 shows the annual temperature duration, also for the buildings as one zone. 26 °C is only exceeded for a few hours in a year. This simulation is done without any forced ventilation air flow rate during the night. However, these whole building simulations are only indicative of the thermal comfort in the building, and simulations on room/zone level have to be done. This is further elaborated in chapter 8.

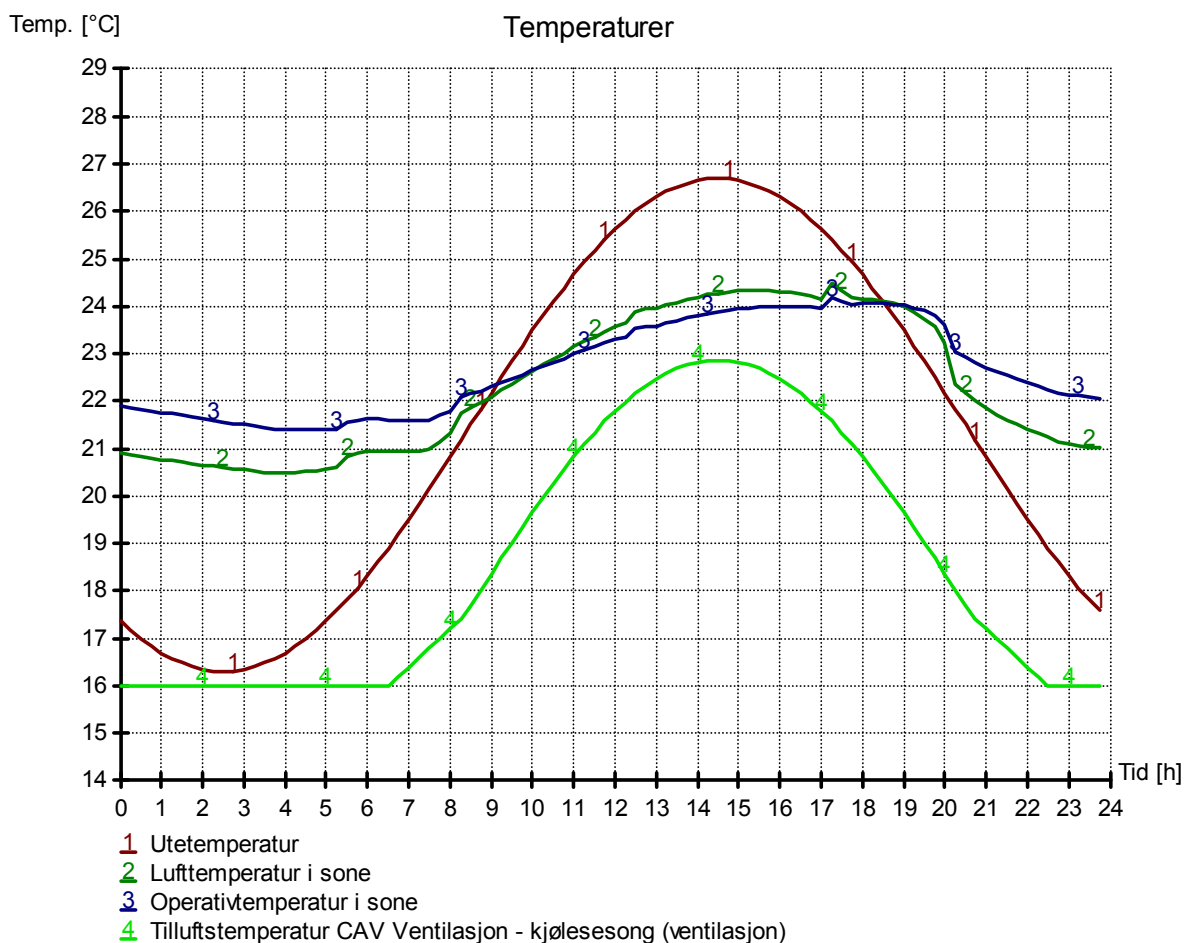

Figure 4.3 Simulated temperatures for the whole building under design summer conditions.

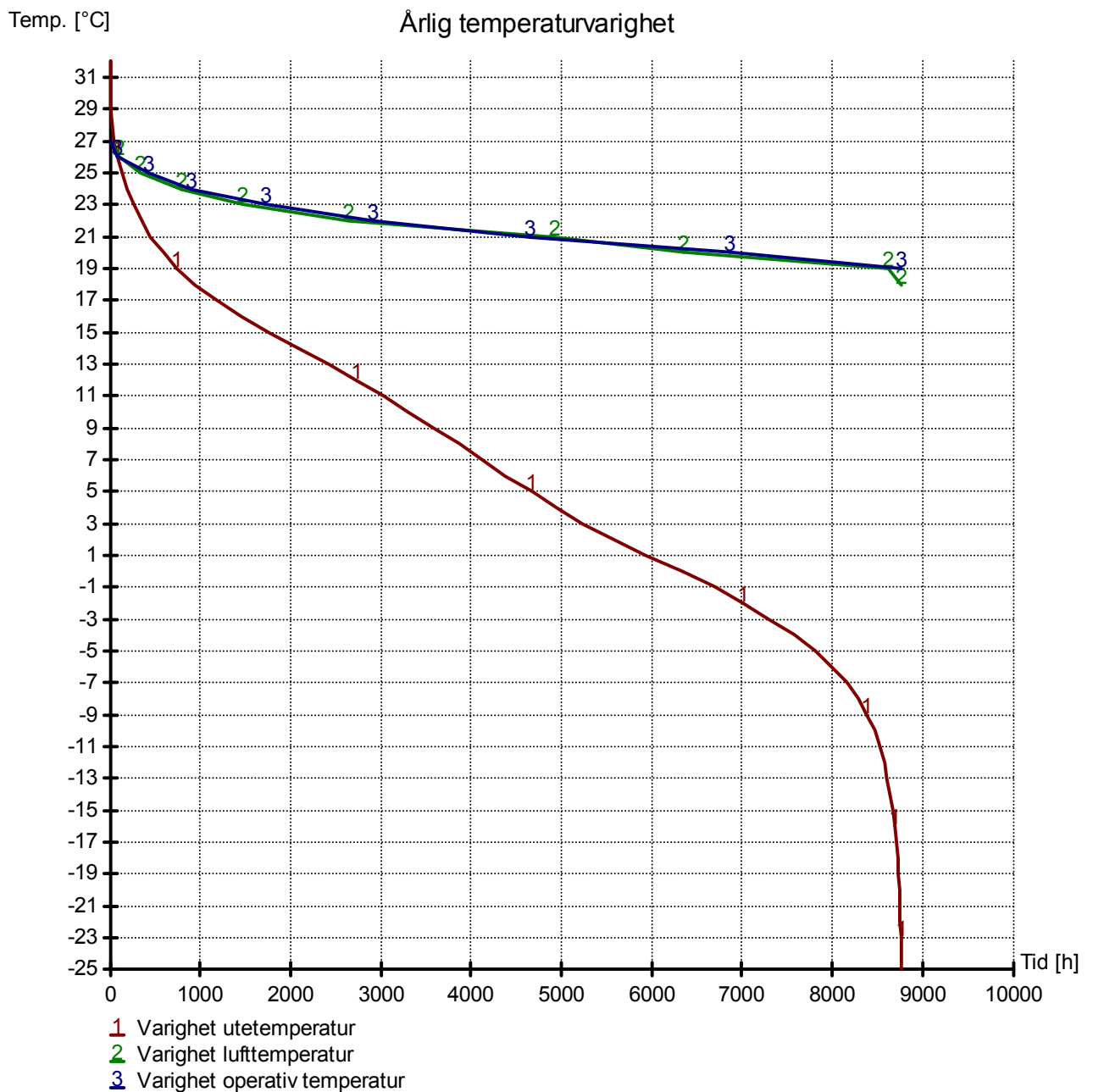

Figure 4.4 Simulated temperature duration for the whole year for the whole building.

4.4 Lights and appliances

4.4.1 Lighting system

The lighting system is assumed to be very energy efficient with a combination of T5 fluorescent lighting and the latest LED-lighting systems. This system is controlled by a combined presence-, daylight- and constant light control system (DALI). When developing NS3701 \1\, Lyskultur did simulations of this kind of system \17\ and proposed an annual light energy indicator (LENI) of 12.5 kWh/m²a. According to Lyskultur this is a rather conservative value and can easily be further reduced without sacrificing good lighting conditions. We have assumed a mean lighting power level of 3 W/m² in operating hours, giving

an annual value of 9.4 kWh/m²a. This should be verified and further elaborated in the continuing concept work.

4.4.2 Appliances

The use of very energy efficient computers, monitors, printers and A/V-equipment, and white goods is assumed. The average power demand/heat load used in the simulation is 4 W/m² in operating hours, leading to an annual demand of 12.5 kWh/m²a.

A typical office cell of 9 m² used by one person will typically have a laptop in a docking station with a flat screen monitor. A typical laptop uses 30 Watt in use, and a typical new LED monitor (20"-24" large) uses around 20 Watt. Assuming on average 6 hour use of the laptop + monitor each working day gives an average heat load/power use of: $6 \text{ h} * (30 \text{ W} + 20 \text{ W}) / (12 \text{ h} * 9 \text{ m}^2) = 2.8 \text{ W/m}^2$. In addition, there will be energy use for printers and white goods in kitchenettes, etc.

In a typical meeting room (25 m²) the A/V-equipment often dominates. The use of two large LED monitors (45" – 50") for presentation and as the video-solution is assumed. Each monitor has a power demand in use of 60 Watt. Assuming 6 hours use in a typical day gives a specific average power demand/heat load in operating hours of: $6 \text{ h} * (2 * 60 \text{ W}) / (12 \text{ h} * 25 \text{ m}^2) = 2.4 \text{ W/m}^2$. In addition, there will be energy use for laptops and possibly also other equipment.

Even if this is preliminary and rough estimates of possible energy use for typical office equipment, it indicates that it is possible to come down to around 4 W/m² in operating hours. This equals 12.5 kWh/m²a. But, future analyses and measurements should be undertaken to verify this.

5. Energy supply system

The energy supply solution for heating, cooling and electricity is an "all electric" solution based on:

- A combined system of a geothermal heat pump and solar collectors covering the total heat demand, giving a very high system COP¹
- The geothermal system is reversed in the cooling season supplying cooling for the ventilation cooling (cooling coil).
- On an annual basis the electricity demand is covered by high efficiency PV, primarily on the roof, but for some alternatives also on the south façade. However, the building will export solar electricity to the grid in parts of the year and import from the grid in periods with not enough PV-production.

This "all electric" solution is in this study chosen for the following reasons:

- It is rather common solution in pilot buildings for zero energy- or plus energy buildings, both internationally \18\ and also for upcoming projects in Norway \19, 20, 21\.
- It is based on already relatively mature and available technology.

However, a lot of other energy supply options are possible for design of zero emission buildings, and will be followed up in the continuation of this concept work. See also chapter 9.

5.1 Solar collector system

Vacuum tube solar collectors placed on the vertical south façade is designed to cover most of the heat demand (domestic hot water (DHW) and space heating)² in May, June, July and August. Test data for vacuum collectors from Conergy AG, model Xinox HP20 \6\, is used. Ten collectors are used, each with an area of 2.87 m² (aperture area of 2.1 m²). Xinox HP20 has a nominal efficiency of 74.5 % and a linear thermal transmittance of 1.43 W/m²K. Other solar producers can deliver collectors with similar performances. The calculation of solar production has been done with the simulation software Polysun \7\. With a 28.7 m² collector area (21 m² aperture area) the solar system delivers 9 208 kWh annually. This is 21 % of the total heat demand for DHW and space heating (44 736 kWh). The COP of the solar thermal system (heat output/energy circulation pumps) is calculated to be very high: 143. More results of the Polysun simulation for the solar thermal system are given in Appendix C.

In summer time the solar collector system will produce more heat than can be used by the building. In such a situation the excess heat can be fed into the geothermal bore holes for the heat pump, to enhance the performance of the heat pump in the winter. This can be regarded as some kind of seasonal storage of solar thermal energy, but it is difficult to estimate its effect without complex simulations taking into account ground conditions, water flows in the ground and more. No effect of this seasonal solar storage has been taken into account in the calculations.

5.2 Heat pump system

The heat pump system is a geothermal system using bore holes to collect heat from the ground. This is a very stable heat source, giving a high and quite constant COP throughout the year. Data used in the

¹ COP: Coefficient of Performance.

² However, in these months there is no space heating demand, only DHW demand.

heat pump simulation in Polysun is from WalterMeier AG, model SI 138 HT (from database in Polysun). This heat pump has a capacity of 38 kW, which is enough to cover the peak heat load for both space heating and DHW. Depending on delivered temperature from the heat pump, the COP varies between 4.5 (at 35 °C) and 3.0 (at 50 °C), assuming a brine temperature from the ground loop of 0 °C. With a low temperature hydronic system with a mean inlet temperature level of 45 °C delivered from the heat pump, the annual COP of the heat pump system is simulated to be 3.3. More results of the Polysun simulation for the heat pump system is given in Appendix C.

Looking at the solar thermal collectors and heat pump as one thermal system, an annual system COP (also called the seasonal performance factor, SFP) becomes 3.7. I.e. one part electricity gives 3.7 times the utilizable heat output. The performance of the coupled solar & heat pump system will be more accurately simulated in a follow-up concept work.

5.3 Cooling system

The low peak cooling demand of 10 W/m², giving only an annual cooling demand of 6.4 kWh/m²a, makes it possible to use the ground (bore holes) as a free cooling source.

Using only circulation pumps and no refrigerating machine gives a very high COP. Based on simulated energy use of the ground–source loop for the heat pump system (Polysun), the COP of the ground cooling is conservatively estimated to be 25.

5.4 PV-system

The design of the PV-system can be seen as the last step trying to achieve the set ZEB-ambition (see section 1.5), when measures to reduce energy use (energy efficiency), reduce emissions from materials³ and designing a high performance thermal energy system have been undertaken (see also Figure 1.1). Two alternative PV-solutions or levels have been investigated:

1. Using the whole roof for PV-production.
2. Using the roof as in alternative 1, but in addition all the available area on the south façade.

The performance of the PV-system has been simulated with the software PV-syst 18\.

5.4.1 Alternative 1: Roof only

The normal way to organize PV-panels on a flat roof is to have arrays of south facing panels with optimal tilt (around 30-40 degrees for Nordic conditions). However, with the low solar height in Norway, either you have to have large space between arrays or you get significant self-shading. An alternative way to solve this is to have panels with a low tilt (10 degrees) alternatingly facing south and north. A 10 degree south facing panel gets an annual flux⁴ of 1021 kWh/m²a, while the north facing gets 828 kWh/m²a. To get rid of the snow in winter a 60 cm gap between each array is made, also making it possible to go between the arrays (maintenance, etc.), see Figure 5.1. With this arrangement on the approximately 17 x 30 meter large roof, it is possible to get 145 south facing modules (each 1.0 x 1.6 m, total of 236 m²), and 116 north facing modules (189 m²).

³ As described in chapter 6, in this phase of the concept study there has been no focus on reducing emission from materials, what can be described as conventional materials/solutions has been applied.

⁴ The optimal solar flux for Oslo climate is 1081 kWh/m²a, for a south facing surface with a 39 degree tilt. Data from Meteonorm (www.meteonorm.com)

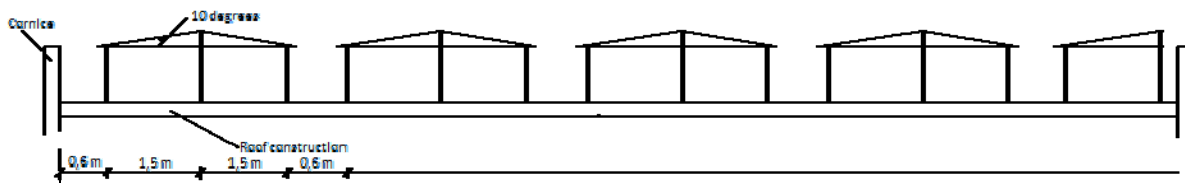

Figure 5.1 Arrangement of PV on the roof.

Data for the PV-module SunPower SPR 333NE WHT-D has been used in the simulations. This is regarded as one of the best on the market, both regarding quality and performance. This PV module has a nominal efficiency of 20.4 %, but with all losses taken into account the annual efficiency is in the order of 17.5-17.9 % (simulated in PV-syst). The total annual electricity production on the roof simulated with PV-syst then becomes 66.2 MWh/a.

5.4.2 Alternative 2: Roof and all available south façade area

In this alternative all available area on the south façade is used for PV panels, see Figure 5.2. Subtracting the window area and the area used for solar collectors, the remaining area can be covered by 156 modules (same Sunpower modules, appr. 250m²). This gives a PV-production of 37.1 MWh/a, and together with the roof a total PV-production of 103.3 MWh/a. More detailed results from the PV-syst simulation are given in appendix D.

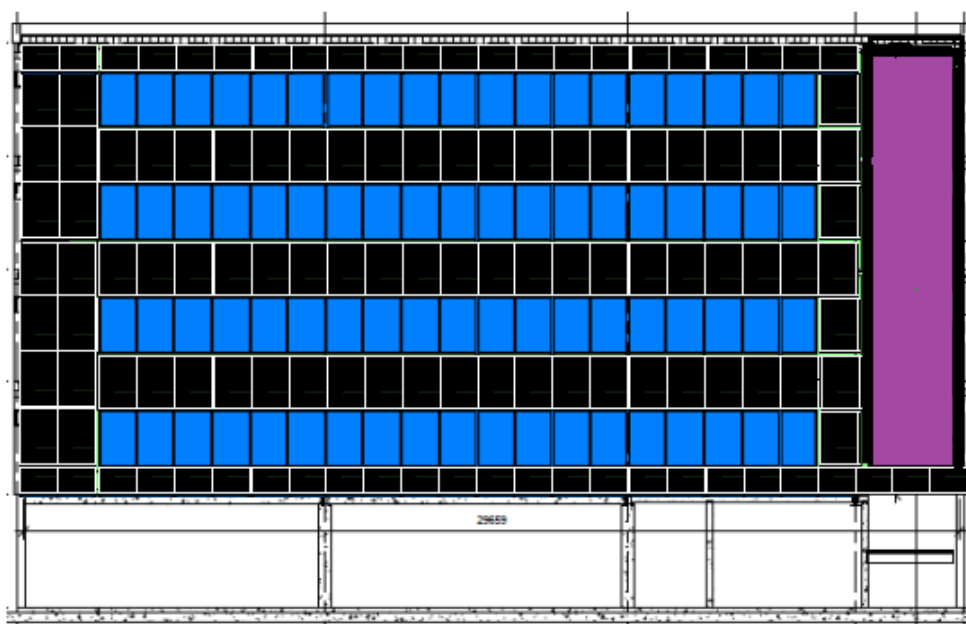

Figure 5.2 Rough schematics for PV on the south façade. The black is PV-panels, the purple solar thermal collectors, and the blue glazed areas (windows).

6. Embodied energy and green house gas emissions

6.1 Method

This chapter describes the calculations on the embodied emissions of green house gases and primary energy connected to the material use in the office concept presented.

The analysis has not considered minimizing the embodied emissions, but only documenting the emissions and energy use with traditional materials.

The results for these calculations are presented with two categories: The IPCC Global warming potential 2007, 100 years scenario for CO₂ emissions, and the cumulative energy demand (CED) version 1.08 calculated with SimaPro \3).

The inputs are structured after the table of building elements, NS 3451 \22).

6.1.1 Goal and scope

The goal of these calculations is to estimate and thereby get an overview of the largest impacts of the embodied green house gas emissions and primary energy connected to the material use in the ZEB - concept for an office building. The calculations are based on the principles of environmental assessment through life cycle analysis, but all life cycle phases are not included at this stage.

6.1.2 Functional unit

The functional unit is 1 m² of heated floor area (BRA) in the office building over an estimated life time for the building of 60 years. The heated floor area is 1980 m². The results are mainly presented with the annualized emissions and energy use, where the functional unit is divided on 60 years.

6.1.3 Boundaries

The boundaries for the analysis are limited to the extraction of raw materials and the manufacturing of the main products and materials needed. Replacement of new materials over the lifetime has also been included.

The expected service lifetime used for the different materials and components is listed in the inventory table attached in Appendix A. The estimated service lifetime of the different inputs is mainly based on product category rules for different materials and components.

The analysis focuses on modules A1-A3 from the standard EN15978 \23) which is material inputs to gate. The use phase B4, replacements, is also included. The different life cycle stages for a building according to EN15978 are shown in Figure 6.1. Most of the materials and components used are analysed with environmental load of the production to gate, but some products are not available in Ecolinvent and have only been included with the estimated raw materials used. The inputs that are only based on raw material production are underlined in the table inventory for LCA in the appendix.

Technical installations have only been included using rough estimates, described in section 6.3.1. Chemicals such as glue –paint and primers are not included in the analysis.

A1-3 PRODUCT STAGE			A4-5 CONSTRUCTION		B1-7 USE STAGE					C1-4 END OF LIFE			
A1	A2	A3	A4	A5	B1	B2	B3	B4	B5	C1	C2	C3	C4
Raw material supply	Transport	Manufacturing	Transport	Construction installation process	Use	Maintenance	Repair	Replacement	Refurbishment	De -construction demolition	Transport	Waste processing	Disposal

Figure 6.1 Stages A1-3 and stage B4, according to EN15978, have been included in this analysis.

The embodied emission and energy calculation will continue to increase in detail as the project on ZEB office concepts continues.

6.1.4 Electricity mix

The choice of different electricity mixes used in the production of the materials used in a ZEB concept can have a decisive influence on the results. The calculations presented here are not based on any single climate gas emission factor for electricity. The inputs are based on the EcolInvent database, where the electricity mix used in the different processes is unchanged. This means that for example the concrete used in the analysis is based on a concrete process from Switzerland with the Switzerland electricity mix as an inputs. The solar cell production is based on the UCTE⁵ electricity mix (the average European mix). Further work on the ZEB-office concept will be to include different scenarios for electricity mix and applying the ZEB-emissions factor where suitable.

6.2 Life cycle inventory - Using BIM

The embodied calculations are mostly based on amounts of material inputs from the building information model (BIM) for the ZEB- office building concept presented in chapter 2. A figure of the BIM model for the office building is shown in Figure 6.2.

⁵ The Union for the Co-ordination of Transmission of Electricity coordinates the operation and development of the electricity transmission grid for the Continental European synchronously operated transmission grid. <https://www.entsoe.eu/the-association/history/ucte/>

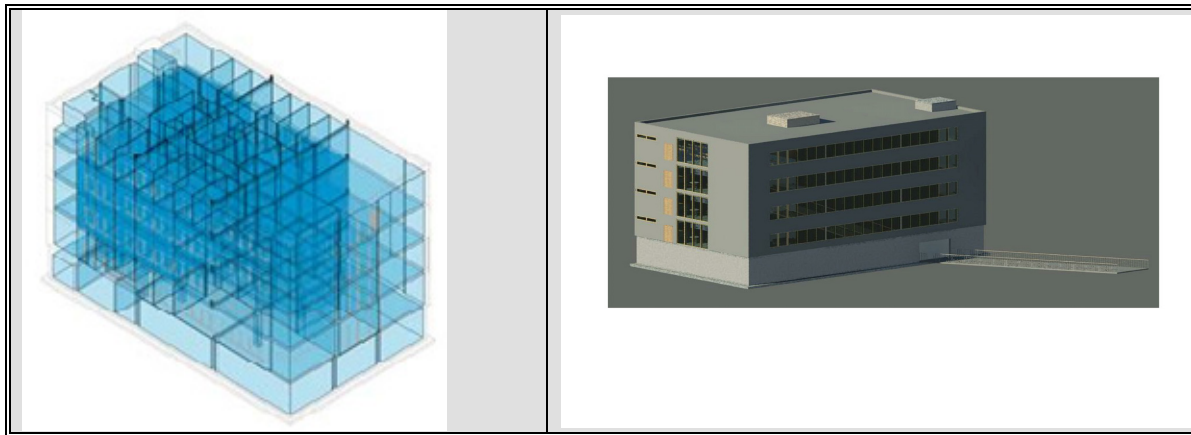

Figure 6.2 BIM of the ZEB office concept building- inner and outer.

The length, area, and volume of different materials and components have been exported from the Revit model (BIM) to excel, and then the amounts have been used in the calculations of embodied emissions and primary energy.

The detailed dimensions of the material inputs have simplified the life cycle inventory phase and improved the level of detail of the material inputs.

The excel lists from the BIM can include a large amount of additional information on the specific material input. Processing the lists, and ensuring that all relevant information gets into the lists, has been an important part of the learning process of this study until now. Below are some examples of using the BIM volumes as the basis for the quantities used in the analysis.

6.2.1 Examples of material inventory from BIM to LCA

Example 1. Material information from the BIM model used on slab structures:

Table 6.1 Excel list from BIM- Amount of concrete in slab –structures and foundations

Betong dekker					
Level	Type Mark	Description	Material: Name	Material: Area m2	Material: Volume m3
U etasje					
U etasje	Betong plasstøpt	Plasstøpt betongdekke	Concrete - Cast In Situ	461	69,15
U etasje	Betong fundament	<i>Betongfundament</i>	Concrete - Cast In Situ	49	34,3
U etasje: 2				510	103,45
1. etasje					
1. etasje	<i>Betong 265</i>	<i>Betongdekke</i>	Concrete	310	82,07
1. etasje	<i>Betong 200</i>	<i>Betongdekke</i>	Concrete	149	29,88
1. etasje	<i>Betong Påstøp30</i>	<i>påstøp</i>	Concrete - Cast in Situ L	474	14,22
1. etasje: 3				933	126,17
2. etasje					
2. etasje	<i>Betong 265</i>	<i>Betongdekke</i>	Concrete	323	85,68
2. etasje	<i>Betong 200</i>	<i>Betongdekke</i>	Concrete	159	31,89
2. etasje	<i>Betong Påstøp30</i>	<i>påstøp</i>	Concrete - Cast in Situ L	474	14,22
2. etasje: 3				957	131,79

The amounts of concrete are divided into different construction parts. This makes it easier to place the material input in the right place in the building element table. Also, the level of detail allows for detailed modeling in SimaPro and simplifies the manual work when changes are made. The architect has

specified the list, both the description of the material input, the type of material and the name of the input. This is helpful when trying to identify suitable material processes.

Encountered challenges

The level of detail in the model reflects the levels of detail you get for the material input. In the example of the slab structures the concrete amounts from BIM are based on a full concrete slab, but in reality the building is dimensioned to use hollow core elements. At this stage hollow core elements have not been entered into the model, and a reduction of 20 % of the total volume compared to compact concrete has been estimated.

The amount of reinforcement steel in the slab is also not included in the model, and the reinforcement steel amounts are based on estimates given by Berit Time.

Example 2. Amount of insulation in inner walls

Table 6.2 Amounts of insulation in inner walls from BIM

Type	LEVEL	MATERIAL TY	NAME	AREA m2	VOLUME m3	LENGTH	WIDTH
V1_dB37		1 Systemvegg	Insulation mineral wool	13	0,91	4100	166
V1_dB37		1 Systemvegg	Insulation mineral wool	13	0,91	4100	166
V1_dB37		1 Systemvegg	Insulation mineral wool	13	0,91	4100	166
V1_dB37		1 Systemvegg	Insulation mineral wool	13	0,93	4200	166
V1_dB37		1 Systemvegg	Insulation mineral wool	13	0,92	4150	166
V1_dB37		1 Systemvegg	Insulation mineral wool	13	0,92	4150	166
V1_dB37		1 Systemvegg	Insulation mineral wool	13	0,92	4150	166
V1_dB37		1 Systemvegg	Insulation mineral wool	13	0,91	4100	166
V1_dB37		1 Systemvegg	Insulation mineral wool	15	1,02	5234	166

This list shows exactly how much volume of insulation goes into an inner system wall with the noise reduction dB37. Here the volume amounts from the BIM have been multiplied by an estimated density of the insulation.

For the inner walls, the level of detail is that steel studs are not entered into the model and can therefore not be extracted from the model. Also, steel rails on the top and bottom of the gypsum inner walls are not entered into the model at this point, and estimates have been made using standardized inner wall solutions from large producers.

Example 3 – Visualizing inputs from BIM

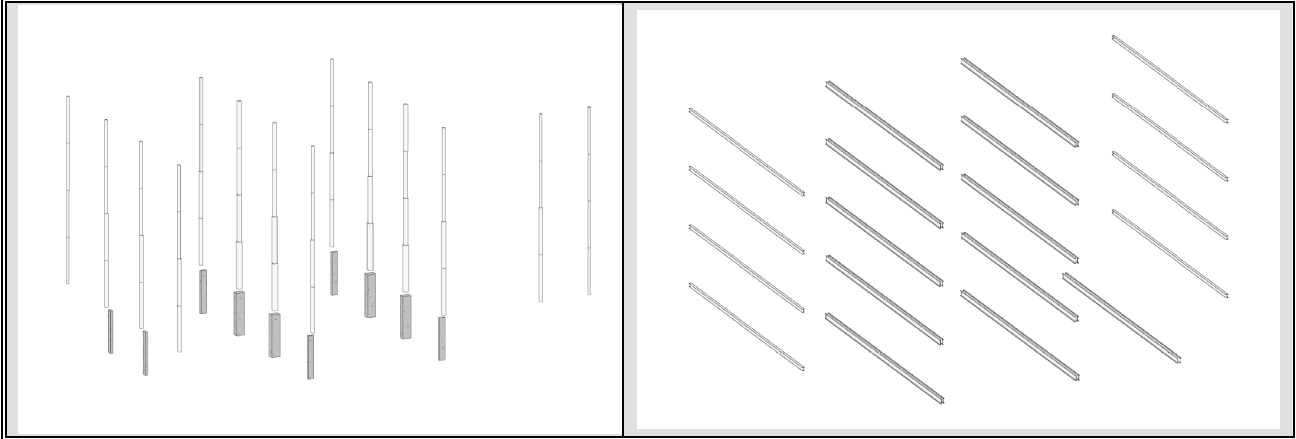

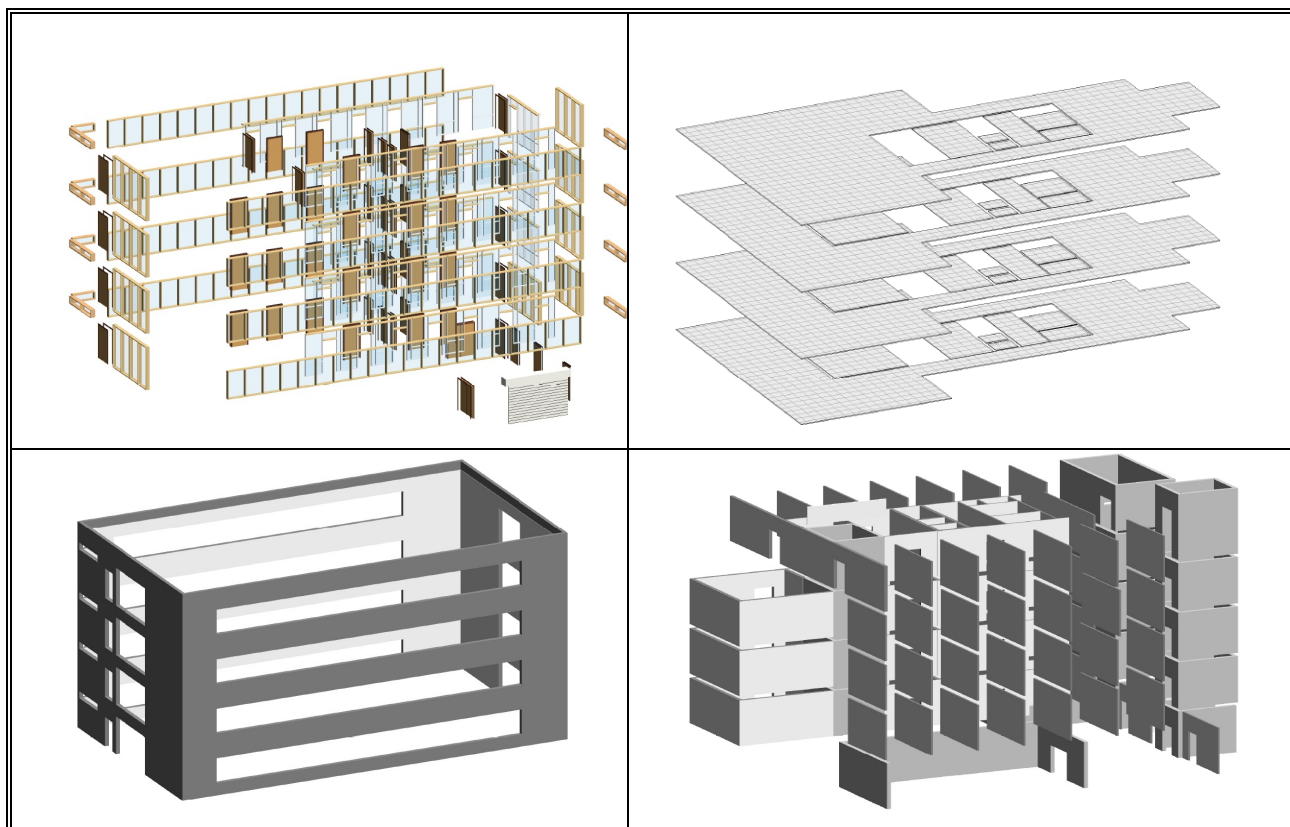

Figure 6.3 Visualizing inputs from BIM.

When working with BIM, it is easy to visualize the material inputs, as shown in Figure 6.3. Visualization of the material inputs assists in the understanding of what inputs are needed and in identifying possible mistakes.

A part of the learning curve has also been to give the different materials and construction parts suitable names in the BIM modeling - names that fit the technical specification the material/construction is supposed to fulfill, such as fire or noise demands, and that can be connected to the table of building elements, but also names that are easily accessible for quality assurance.

6.3 Life cycle inventory – environmental data, technical installations and simplifications

The material inputs are mainly based on environmental data from the EcolInvent database version 2.2, but EPD⁶s have been used for the façade and floor materials. All material inputs as well as information about the EcolInvent processes used are listed in the table in appendix A.

6.3.1 Technical installations

Technical installations include electrical installations, ventilations system, water supply systems, lightning systems, heating system and in the ZEB case energy supply systems such as the PV system. The technical systems used in the concept model have not been properly dimensioned yet, and only rough estimates have been used in the embodied emission analysis for now.

⁶ EPD: Environmental Product Declaration

In this analysis the following inputs for the technical installations are used:

- Estimates for electrical cabling based on experience from ZEB pilot buildings
- Estimates on metals used in ventilations system, ducts, air handling unit, etc. based on experiences from pilot buildings and literature
- Solar thermal collectors (28 m² vacuum collectors), process from EcoInvent, 20 year lifetime, with an estimate of 20 % for support structures.
- Estimates for solar cells, mono crystalline solar cells⁷ 30 years lifetime – with 20 % needed for the supporting power system (balance of system) 50 % more efficient production process in 30 years. Total area of solar cells is based on alternative 2 with 236+189+250 = 675 m² PV panels.

6.3.2 Simplifications and uncertainty

The amount of reinforcement steel is based on 30 kg per m³ concrete for hollow core elements and 75 kg /m³ for other concrete structures with reinforcement steel. The technical units are based on rough dimensions and estimates and will require detailed dimensioning and further work, especially on gathering environmental data for the different components involved. The estimated service lifetime for the solar cells (30 years) is based on guidelines from the IEA⁸ on LCA for solar cells. The service lifetime for solar cells is uncertain and very dependent on the quality of the actual solar cells used. Material losses of building materials on site are not included in the analysis. The service life time of the different materials and components used is also a very large uncertainty factor and needs further attention.

6.4 Results

6.4.1 Carbon dioxide emissions

This section presents the results from the current inventory. In Table 6.3 the total carbon dioxide emissions for the functional unit and the functional unit per year are presented. In Figure 6.4 the results for the emissions per functional unit per year are shown graphically divided on the initial material use and replacements over the estimated lifetime of 60 years.

Table 6.3 Climate gas emissions from material use for the ZEB-concept

Phase	Kg CO ₂ eq /m ²	Kg CO ₂ eq/m ² per year
Initial material use	384	6.4
Replacements	126	2.1
Total	510	8.5

The climate gas emissions at this stage of the calculation are 510 kg per functional unit and approximately 8.5 kg CO₂ eq / m² in annualized emissions.

⁷ Solar PV panel based on: Photovoltaic cell, single-Si, at plant/m²/RER Production of photovoltaic cells (156*156 mm²). Wafer thickness 270-300 um, with an efficiency of 15.4% and 1.5Wp; Geography: Data for production in Europe. UCTE electricity mix.

⁸Methodology Guidelines on Life CycleAssessment of Photovoltaic Electricity http://www.iea-pvps.org/fileadmin/dam/public/report/technical/rep12_11.pdf

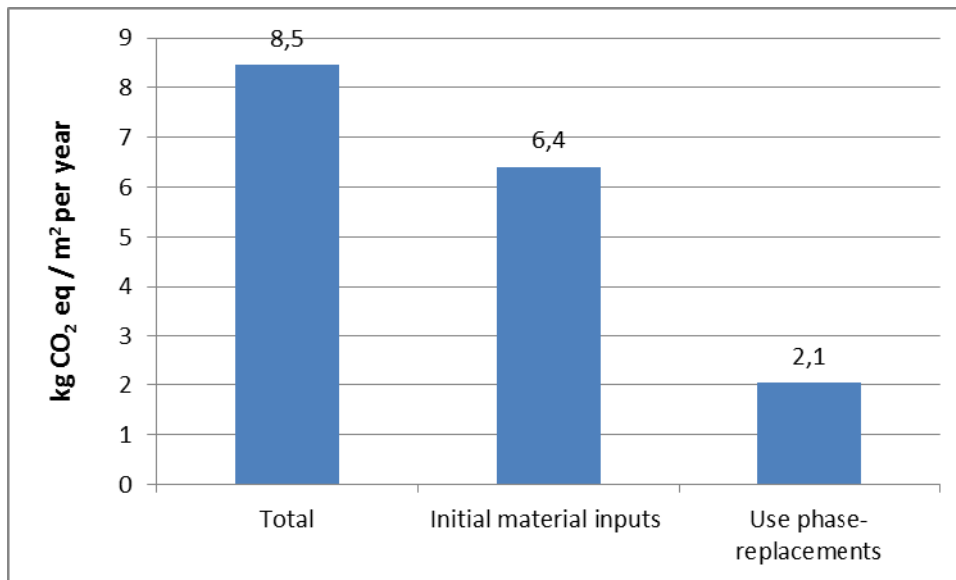

Figure 6.4 Total climate gas emissions for the inputs included at this stage, total and divided in to pre use phase and replacements - functional unit per year.

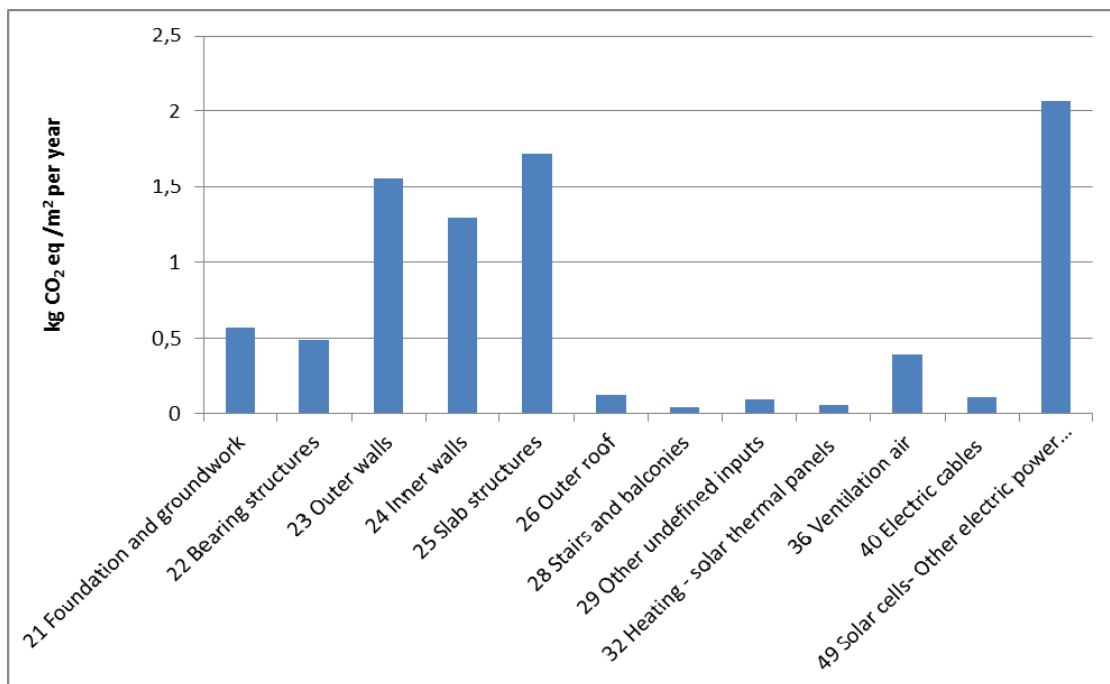

Figure 6.5 Climate gas emissions for total material inputs over the lifetime, divided by the table of building elements- per square meter per year of the estimated lifetime of 60 years.

It is clear that the solar cells and the concrete and steel in the slab structures, inner shaft walls and foundation are the largest contributors to the emissions. If the solar cells are not estimated to be produced in a 50 % more efficient way in 30 years, and the same Ecolnvent process is used unchanged for the use phase, the total emissions will be 9.1 kg /m² per year, i.e. 0.7 kg higher. This indicates that the PV panels alone account for between 2.1-2.8 kg /m² per year, depending on the replacement scenario.

The concrete emissions are not based on low carbon concret. By replacing the normal concrete with low carbon concrete the emissions can be reduced.

In Figure 6.6 the emissions from the main material inputs and technical installations are shown.

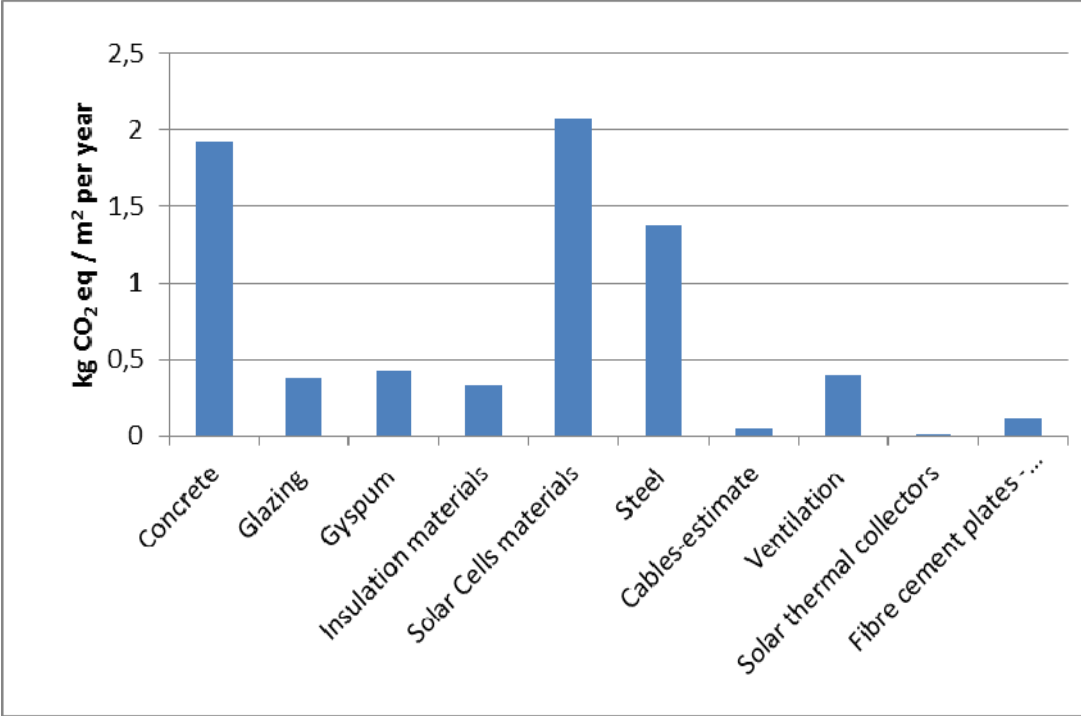

Figure 6.6 Greenhouse gas emissions for the main materials and technical installations

6.4.2 Embodied primary energy use – fossil and renewable energy

Figure 6.7 shows the results for total primary energy use, calculated with the cumulative energy demand method. The total embodied energy in the materials at this stage is 41.2 kWh/m² per year.

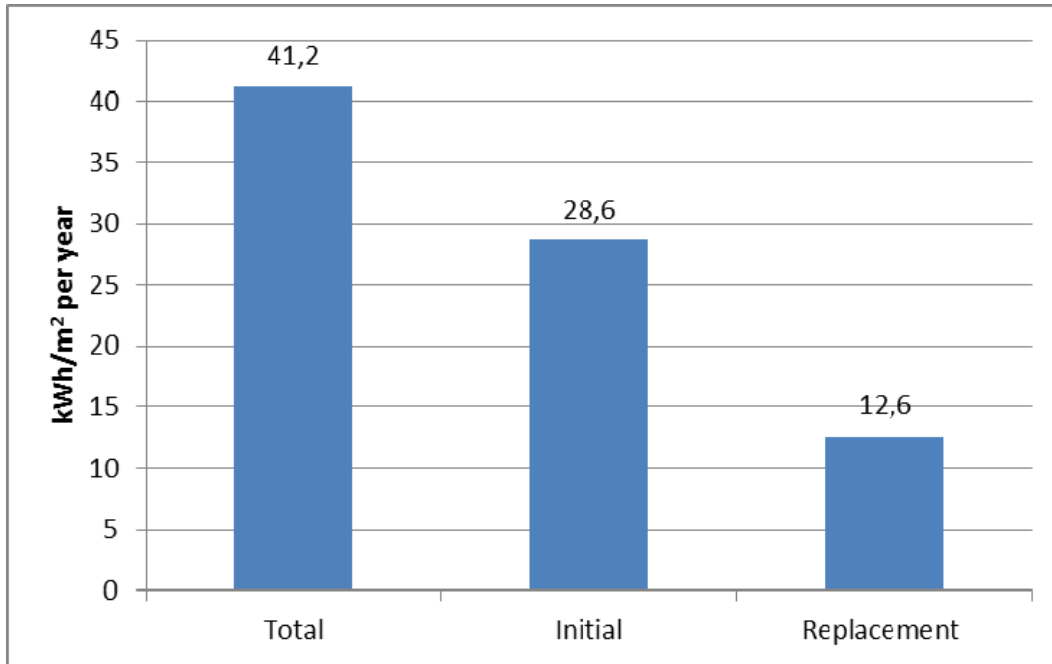

Figure 6.7 Embodied primary energy connected to inputs from the EcolInvent processes and EPDs for Cembrit façade material and linoleum floor material.

The division of the embodied energy into the main materials used is shown in Figure 6.8.

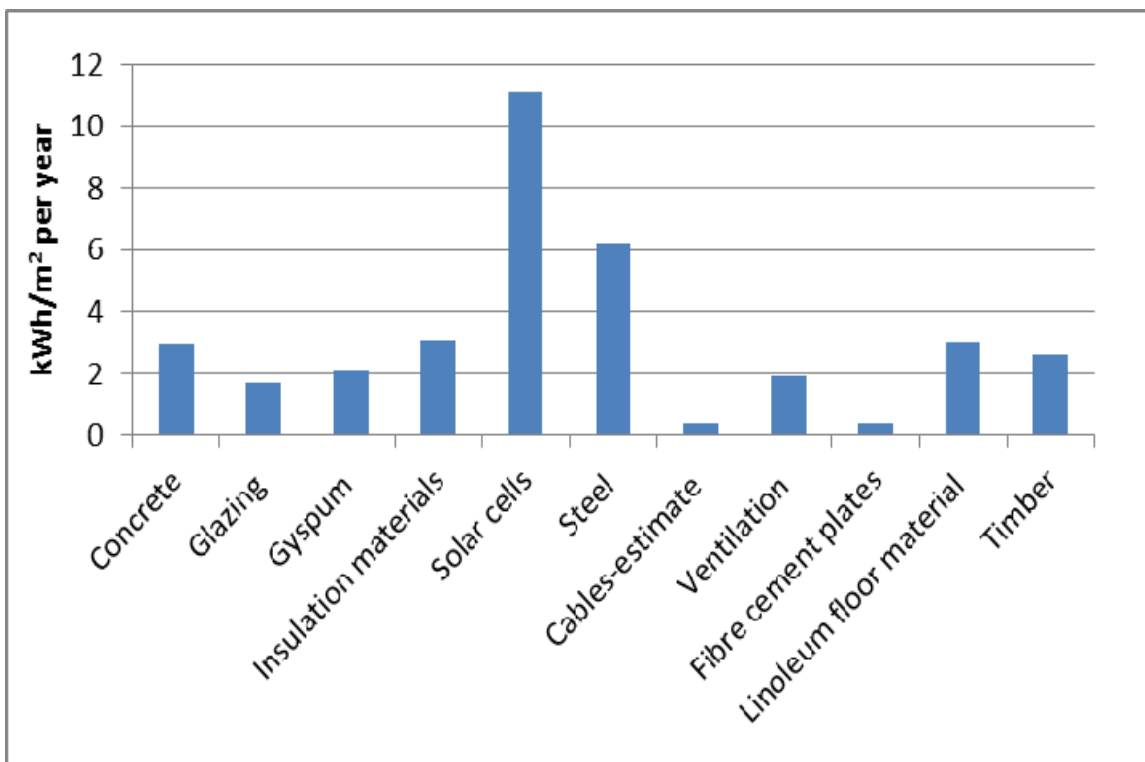

Figure 6.8 Division of embodied primary energy for main materials and technical installations

7. Energy and CO₂ calculations

This chapter draws together inputs from chapters 2-6 and calculates total energy use and life cycle CO₂ for both emissions from operation and embodied emissions from materials. The analysis in this chapter has the following structure:

1. First calculation of the net energy budget (net demand), section 7.1.
2. Splitting of the demand into electric, thermal heating and thermal cooling demand, section 7.2.
3. Calculation of how the thermal energy supply meets the thermal demand (heating and cooling), section 7.3.
4. Calculation of the gross delivered energy and the related CO₂-emissions for operation, section 7.4.
5. Calculation of the CO₂ emissions from both operation and materials, section 7.5
6. Design of the on-site electricity production, and calculation of the total life cycle CO₂ balance, section 7.6.

Step 6 gives the answer of whether the PV-production meets the (different) ZEB-definition levels given in paragraph 1.5.

7.1 Net energy budget

The total net annual energy demand, as defined in NS3031 \11\, is 57 kWh/m²a (112 827 kWh/a). This is a very low number for an office building, but is based on state-of-the-art technology as described in the foregoing chapters. Figure 7.1 gives the annual demand for different energy items (purposes), with space heating, appliances and lighting as the largest energy users.

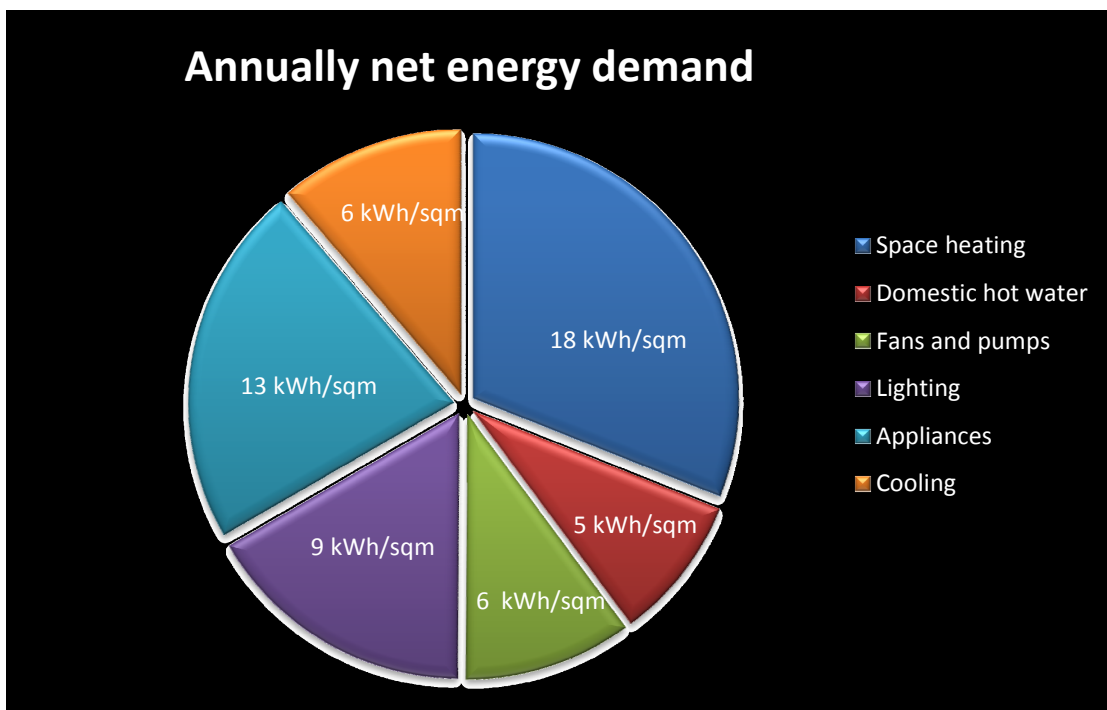

Figure 7.1 Annual net energy demand (budget) according to NS3031 \11\.

7.2 Splitting into electricity-specific and thermal demands

The net demand calculated in section 7.1 can be split into heating demand, cooling demand and electricity demand. As seen in Figure 7.2, the largest demand is the el-specific demand, with 49 %, followed by the heating demand, with 40 %. The cooling demand is rather small with only 11 % of the total demand.

Due to the low DHW demand, the total heat demand is dominated by the space heating demand and varies according to a typical yearly curve for very energy efficient buildings, as shown in Figure 7.3. The heating season is approximately 6 months, with April and October as the transition months between the heating season and the cooling season.

As expected, the el-specific demand is quite constant over the year⁹, as shown in Figure 7.4.

The cooling demand variation, shown in Figure 7.5, is confined to the four warmest months. Simulations indicate that September and parts of October and April are "free running" periods, where there is no heating or cooling demand. The length of the free-running periods (spring and autumn) can be a measure of how good the passive design of the building is. An extreme case could be a building without heating and cooling demand, i.e. it is free running all year, but this is probably unrealistic in Norwegian climate conditions. But, extending these free running periods in the spring and autumn may be interesting and will be studied in the continuation of the concept work.

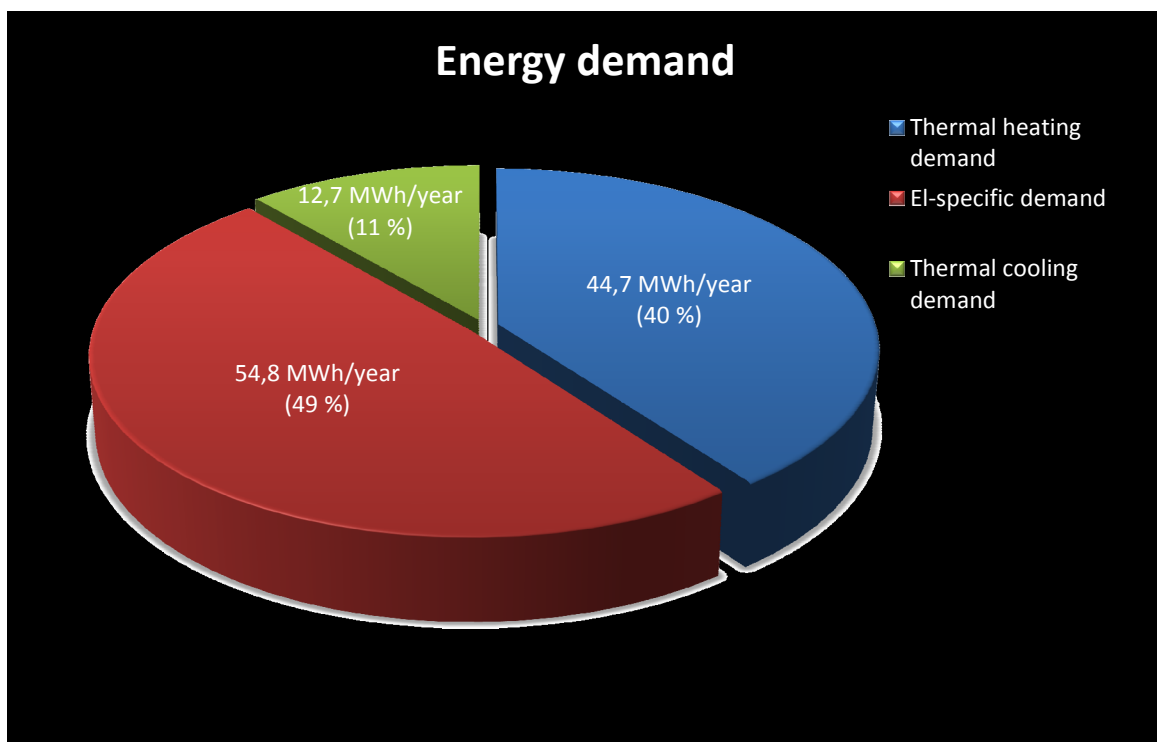

Figure 7.2 The annual energy demand split into thermal (heating and cooling) and el-specific demand.

⁹ According to NS3031 a year round operation of office buildings is assumed, and the load from lighting and appliances is also assumed constant over the year. It can be discussed how realistic this is, and it will be further elaborated in a future concept work in ZEB.

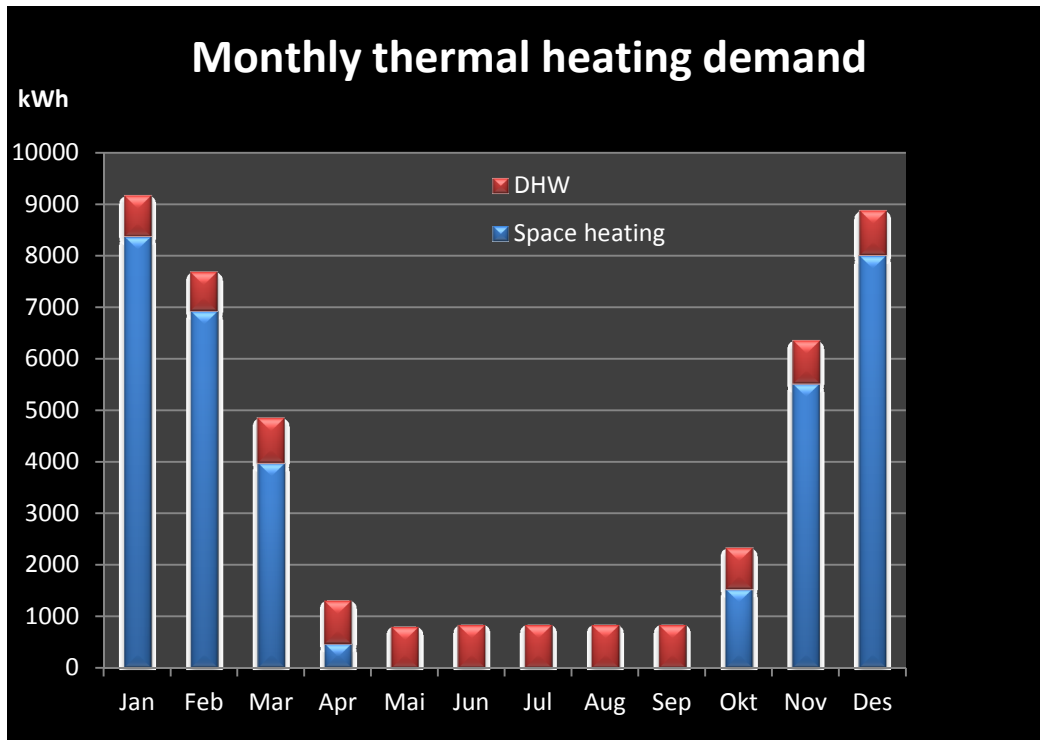

Figure 7.3 The annual variation in thermal heat demand (DHW and space heating).

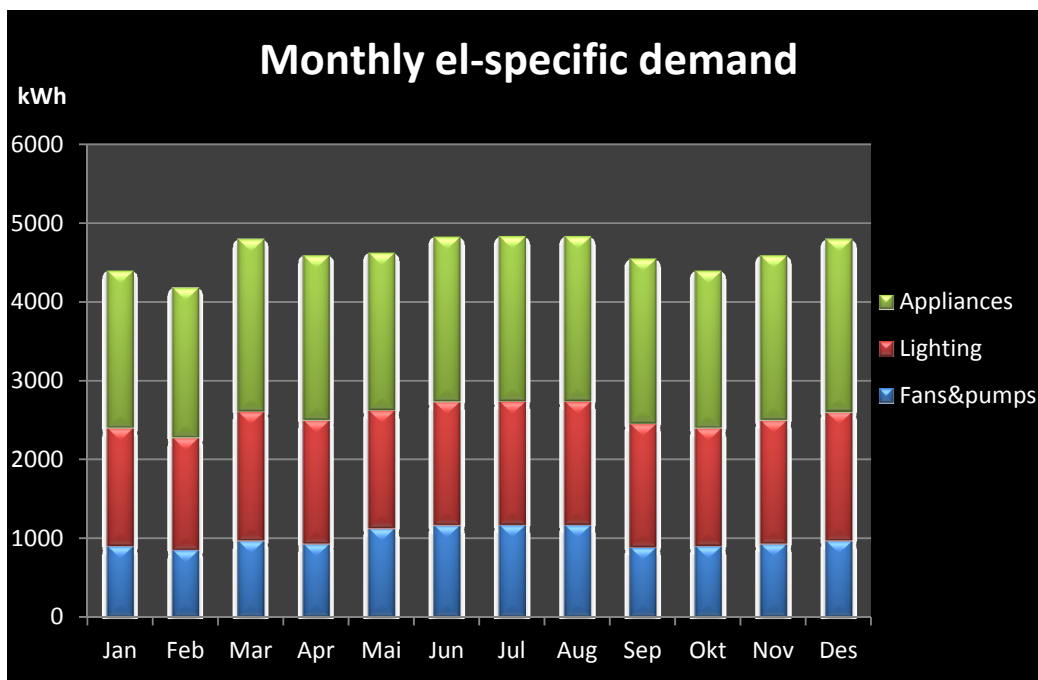

Figure 7.4 The annual variation in the el-specific demand.

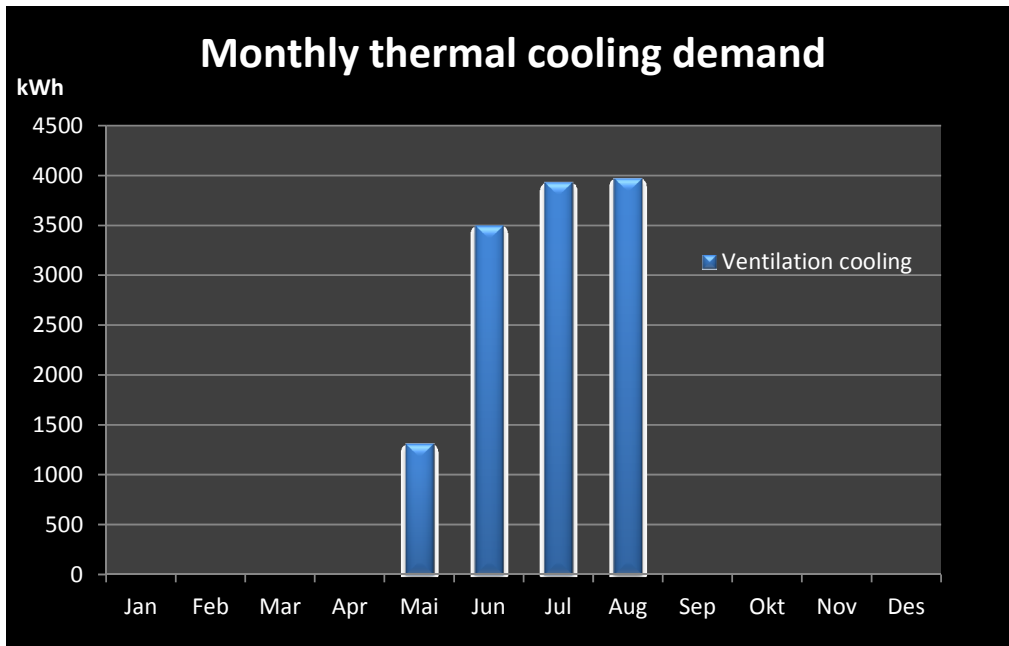

Figure 7.5 The annual variation in the cooling demand.

7.3 Thermal energy supply system

As described in chapter 5 the thermal heating demand is covered by a combined solar collector and geothermal heat pump system. The solar collector system mainly covers the domestic hot water (DHW) demand in the summer months (roughly April-September), while the heat pump system mainly covers the space heating and DHW demand in winter. The heat pump system can be shut down from May to September, as shown in Figure 7.6.

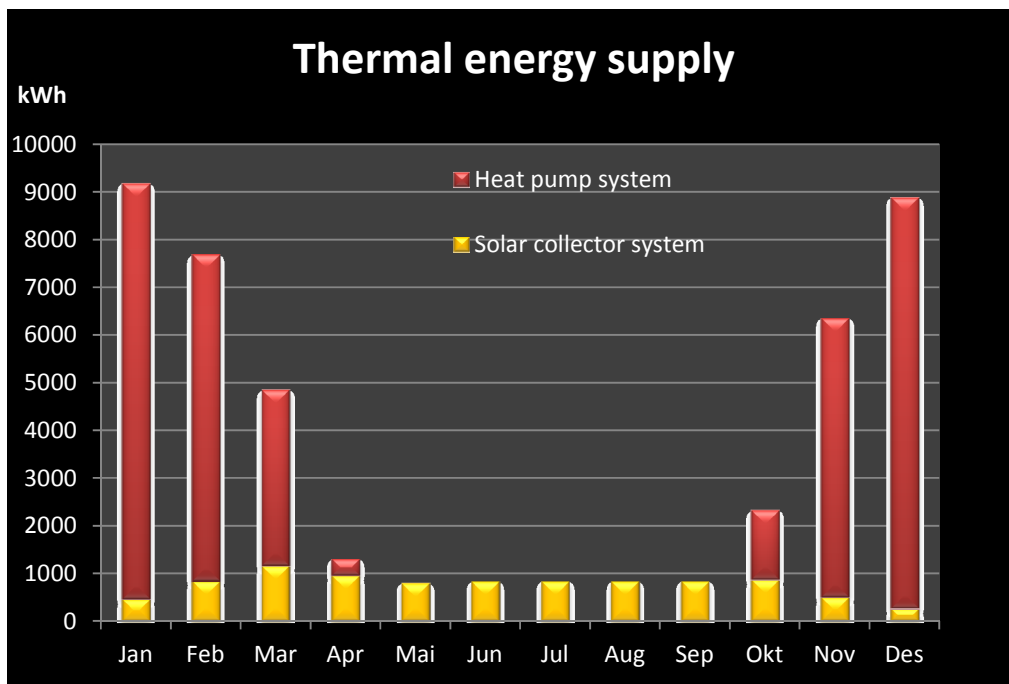

Figure 7.6 The annual variation in heat energy supply from the solar collectors and the heat pump system.

Due to very high COP of the solar collector system (COP = 143) and the geothermal ground cooling system (COP = 25), only using circulation pumps to deliver "free" heat and cooling, the electricity needed for these two systems is very small, as shown in Figure 7.7. The main electricity need for the thermal supply system is for the heat pump system, with an annual need of 10 766 kWh_{el}. The solar and cooling systems need 72 and 509 kWh_{el} respectively.

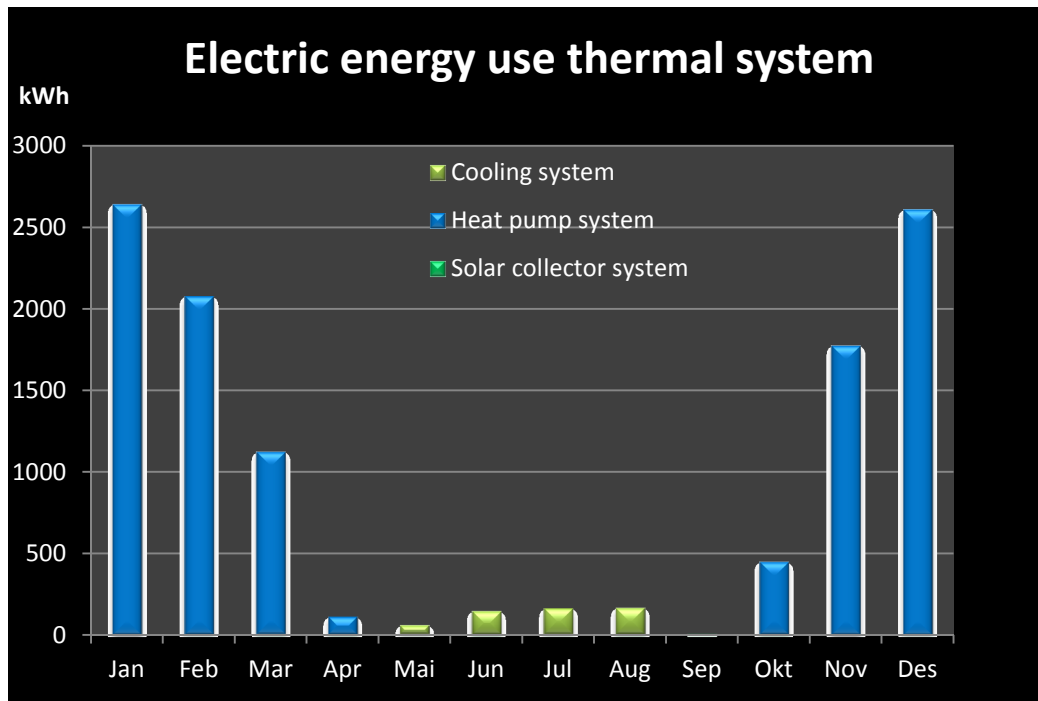

Figure 7.7 The annual variation in electricity needed for the thermal energy supply system.

7.4 Gross delivered energy and related CO₂ emissions

Summation of the el-specific energy demands in section 7.2 and the electric needs for the thermal system in section 7.3, gives the total delivered electricity for the building, as shown in Figure 7.8. However, this does not take into account the PV electricity production and is therefore noted as gross delivered electricity. The main drivers for delivered electricity is appliances (38 %) and lighting (28 %), followed by fans & pumps (17 %) and the heat pump system (16 %). The total annual delivered electricity is 33 kWh/m² (65.7 MWh per year).

Since all (gross) delivered energy is electricity, the CO₂ emissions from operation is proportional to the delivered energy, as shown in Figure 7.9. The total annual CO₂ emissions from (gross) energy used for operation is 4.3 kg/m² (8.5 ton per year).

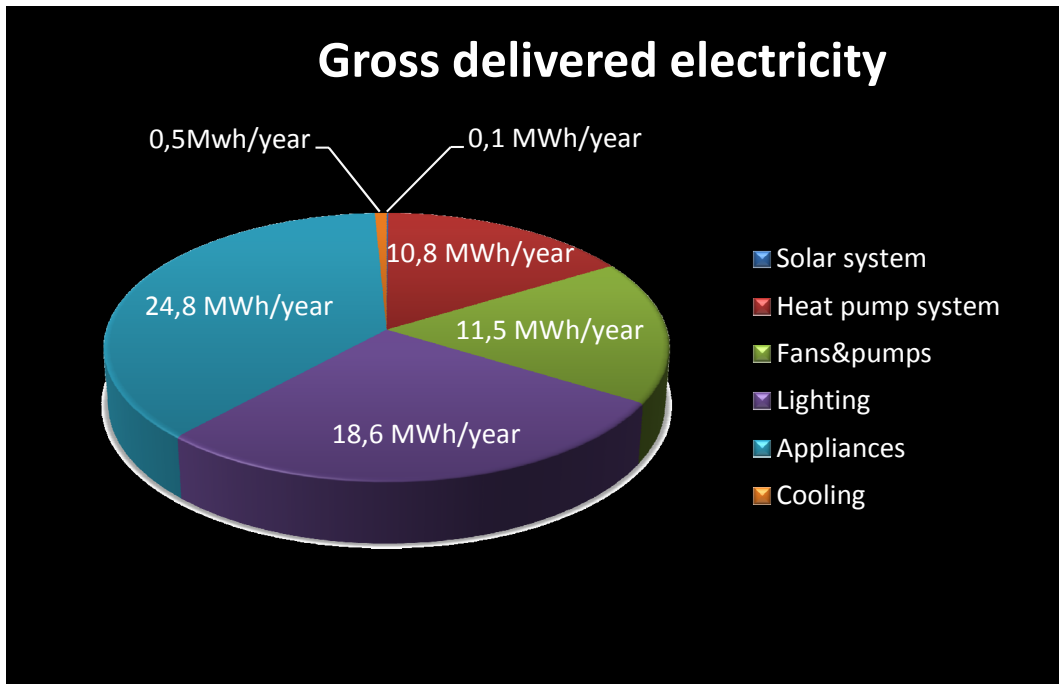

Figure 7.8 Annual gross delivered electricity for the building.

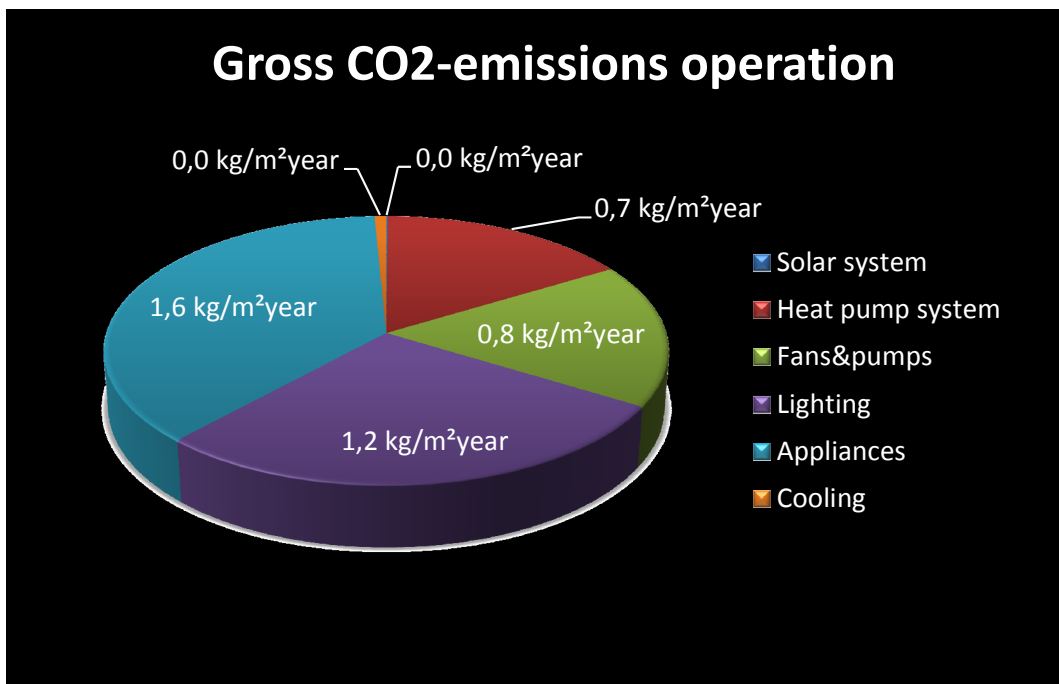

Figure 7.9 Annual gross CO₂ emission due to energy use for operation of the building.

7.5 Embodied and total CO₂ emissions

Embodied CO₂ emissions for the building, as calculated in chapter 6, is shown in Figure 7.10. The total emission amounts to 8.5 kg/m²a. Concrete, gypsum boards, and reinforcement steel are the largest contributors to the emission.

Even if there is significant uncertainty regarding the embodied emissions, these numbers indicate that for this case the embodied emissions are larger than the emissions related to the energy used for operation. According to the current calculations, embodied emissions constitute 66 % of the total emissions, as shown in Figure 7.11. The total CO₂ emissions that have to be balanced by PV-production is 12.8 kg/m²a if the most ambitious ZEB-level (see paragraph 1.5) is to be reached.

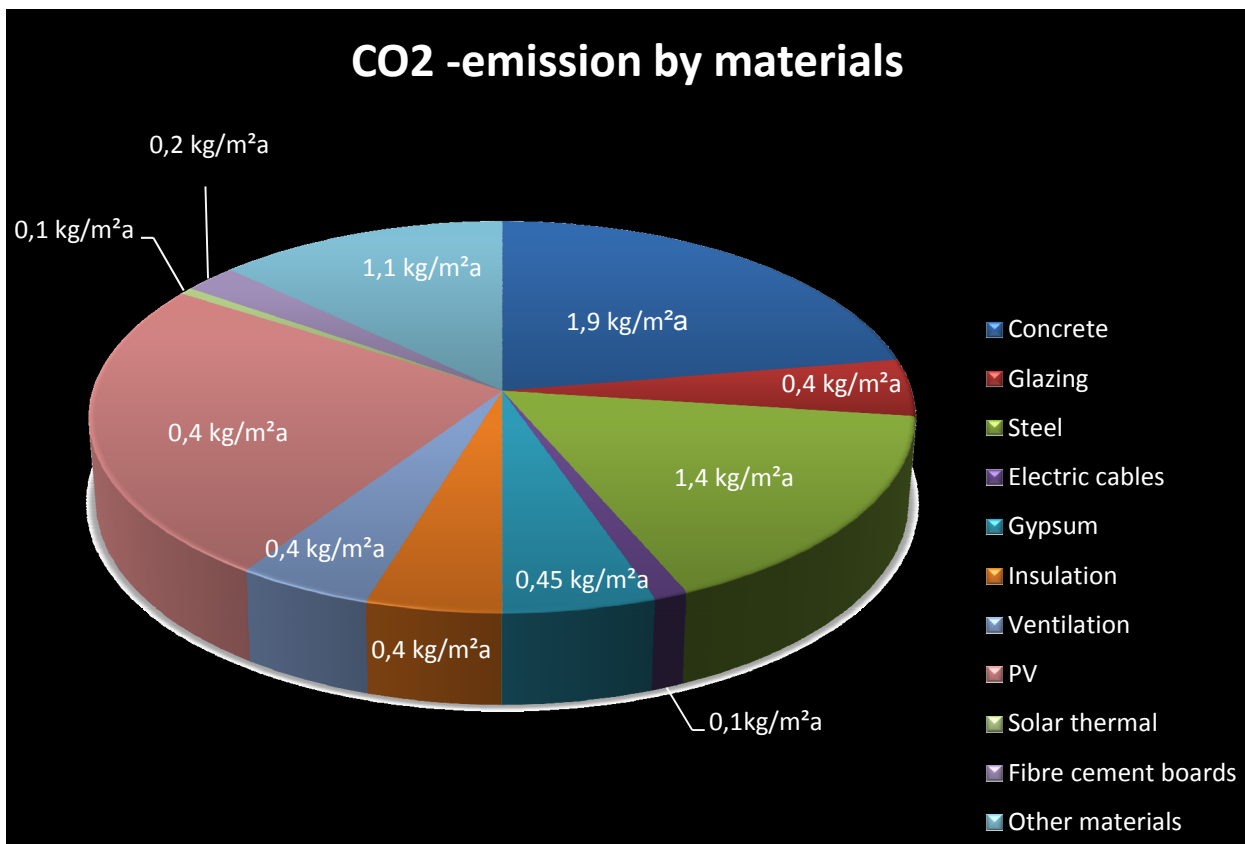

Figure 7.10 Annual embodied CO₂ emissions from materials.

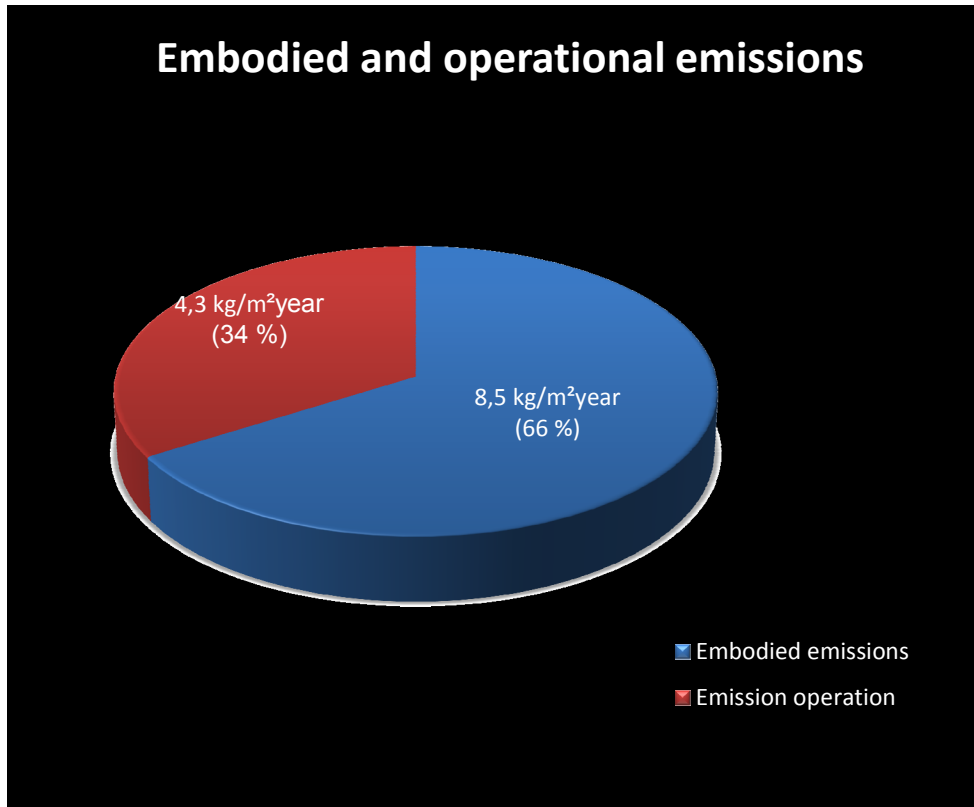

Figure 7.11 The magnitude of embodied emissions and emissions from operation of the building.

7.6 Design of on-site electricity production and total CO₂ balance

As calculated in paragraph 7.5, the total CO₂ emissions amount to 12.8 kg/m²a, or 25.4 tons CO₂ per year. With a CO₂ factor of 0.13 kg/kWh, the necessary PV-production¹⁰ has to be $25\,376 / 0.13 = 195\,198$ kWh per year. That amounts to 99 kWh per sqm heated floor area and year, which is a very high number to achieve under Norwegian climatic condition (as we will see).

Two alternative PV-arrangements or levels, as outlined in paragraph 5.4, will be analyzed:

1. Using the whole roof for PV-production.
2. Using the roof as in alternative 1, but in addition using all the available area on the south façade.

7.6.1 Alternative 1: Only roof-mounted PV

As calculated in paragraph 5.4 the roof mounted PV will have a yearly production of 66 200 kWh. This is equal to 33 kWh per sqm heated floor area per year, which is the same as the yearly energy (delivered electricity, 33 kWh/m²a) used for operation. Thus, this alternative can be called a zero energy building. However, the PV-production is not close to balance the total CO₂ emission (12.8 kg/m²a). Only 34 % is covered, as illustrated in Figure 7.12. But, it satisfies the ZEB-O level as defined in paragraph 1.5.

¹⁰ This is based on the assumptions that exported electricity to the grid will offset equivalent amount of electricity in the central el-grid system, produced with the same mean CO₂-emissions as the imported (bought) electricity. I.e. the same CO₂-factor is used for both exported and imported electricity (symmetric CO₂-factor).

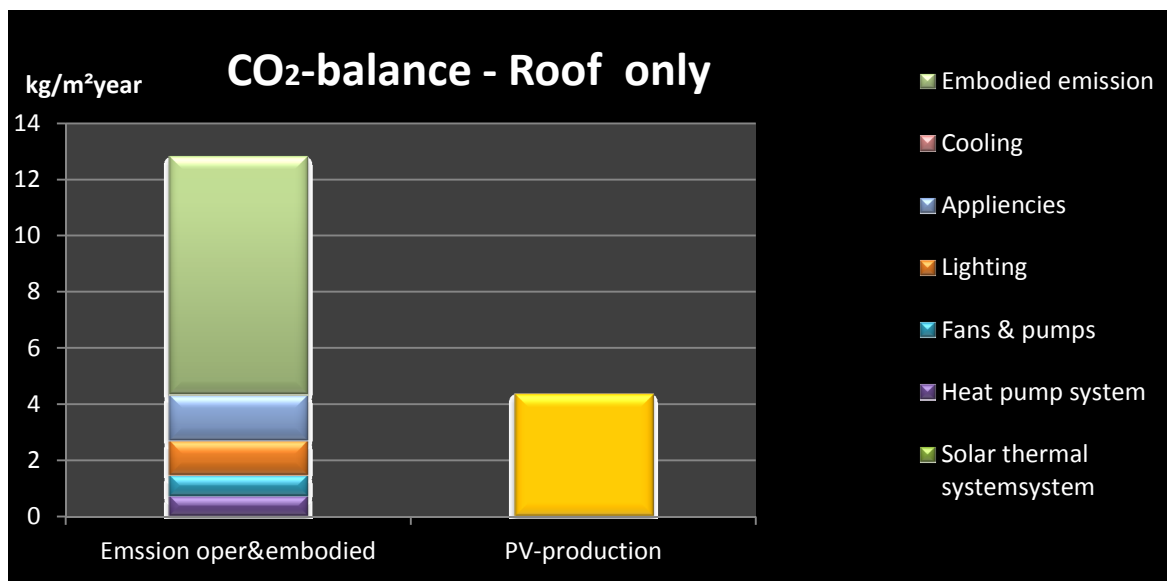

Figure 7.12 CO₂ balance between embodied emissions and emissions from energy use for operation and PV-production. With only roof mounted PV.

7.6.2 Alternative 2: Roof and all available south façade used for PV

In this alternative, where all the available south façade is utilized, the annual production is further raised, to 103 300 kWh per year, or 52 kWh per sqm heated floor area per year. This is a "massive" plus energy building with an annual net export of electricity of 19 kWh/m²a. However, as shown in Figure 7.13, this is still only about 50 % of the total emissions. So, even exploiting all available roof- and south facing façade area, it is not even close to covering the total emissions.

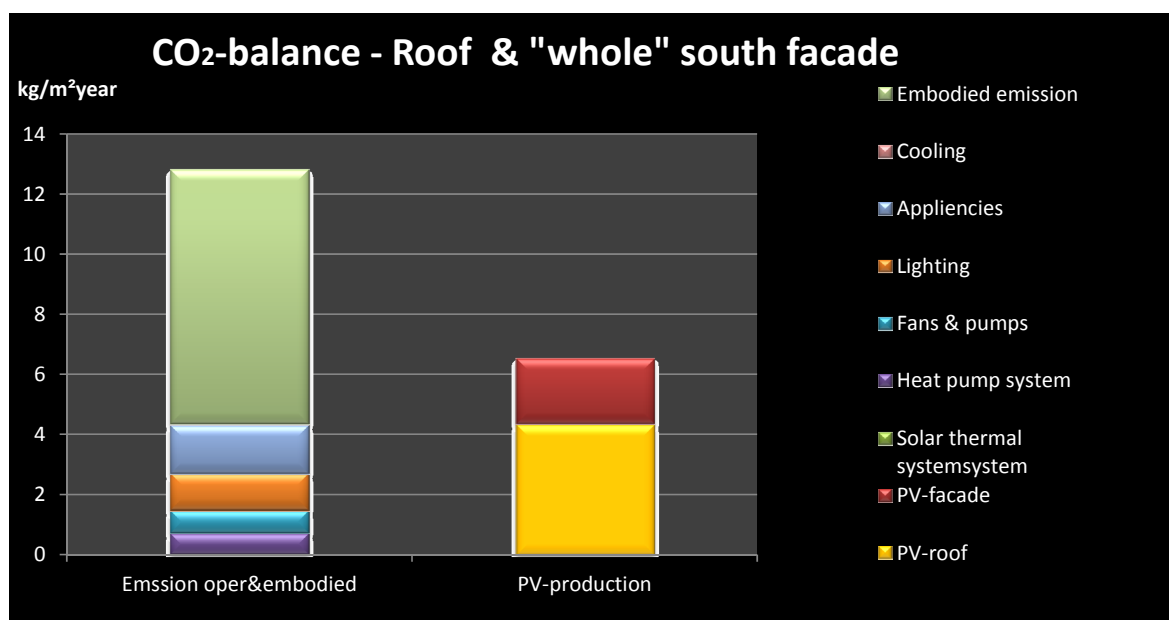

Figure 7.13 CO₂ balance between total emissions and PV-production. With both roof and all available area of south façade used for PV panels.

7.7 Mismatch in demand and production

The alternatives described in paragraph 7.6 both have a PV production which is equal to or higher than the energy demand (delivered electricity). Hence, some of the solar electricity produced has to be exported to the grid. In addition, the solar production will be very much larger in summer than in winter. This is contrary to the electricity demand, which is larger in winter mainly due to the space heating demand, and adds to the challenge of mismatch between energy production (PV) and electricity demand. The mismatch between production and demand can be "measured" by two factors:

1. The monthly load mismatch factor (f_{load}), which is a generalization of the solar fraction calculated for solar thermal systems. It tells how much of the monthly (electricity) demand that is covered by the production (PV).
2. The monthly exported fraction (X) of the produced energy (PV), which tells how much of the production that has to be exported to the grid.

The production and demand are here only calculated with a monthly resolution and will therefore not be a realistic measure of the real exported energy and mismatch for such a building. But, it still gives a clear indication of the mismatch between production and demand.

7.7.1 Mismatch with only roof-mounted PV

Figure 7.14 shows the mismatch between PV-production and electricity demand, in the case with only roof mounted PV. In the six months April to September the PV-production covers the demand, but rest of the year there is net import of electricity from the grid¹¹. The annual mismatch load factor is $f_{load} = 0.60$, meaning that 60 % of the electricity demand is met by PV-production and that 40 % has to be imported from the grid. The export fraction is $X = 0.40$, meaning that 40 % of the PV-production has to be exported to the grid, while 60 % of the production goes to self-consumption.

¹¹ As mentioned in paragraph 5.4, it is assumed that there is no production in December, January and February due to snow covering the nearly flat PV-panels on the roof.

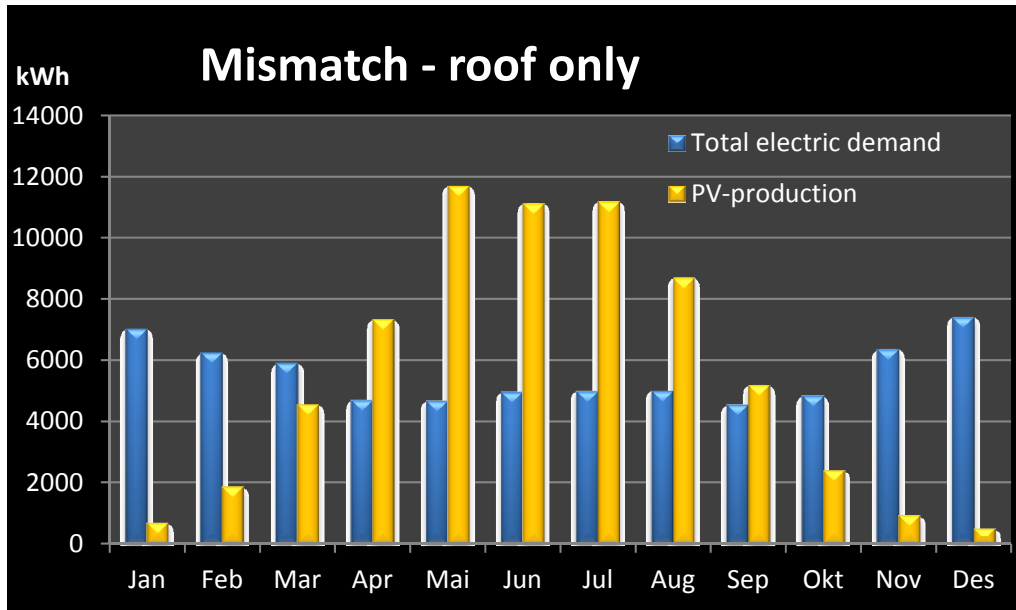

Figure 7.14 Monthly mismatch between PV-production and electricity demand. Alternative with roof mounted PV only.

7.7.2 Mismatch with roof and all available south façade used for PV

In the case with roof mounted PV and all available area of the south façade covered with PV, the mismatch is given in Figure 7.15. In this case the PV-production covers the demand eight months of the year, from March to October. There is net import of electricity from the grid only during four months. The annual mismatch load factor is $f_{load} = 0.76$, meaning that 76 % of the electricity demand is met by PV-production, and 24 % has to be imported from the grid. The export fraction is $X = 0.51$, meaning that 51 % of the PV-production has to be exported to the grid, while 49 % of the production goes to self-consumption.

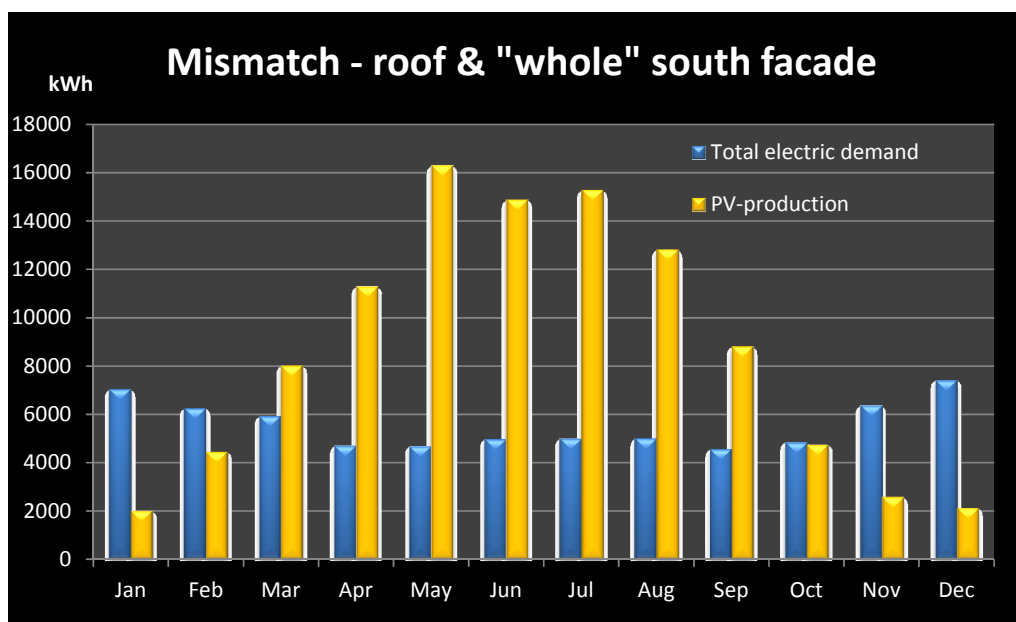

Figure 7.15 Monthly mismatch between PV-production and electricity demand. Alternative with roof mounted and all of the available area of the south façade covered by PV.

8. Indoor climate simulations

To analyze the indoor climate three rooms/zones have been chosen:

- A typical south facing office cell, 9 sqm floor area
- A typical south facing open plan office for 12 workplaces, 59 sqm floor area
- And an internal meeting room for 12 persons, 23 sqm floor area

Figure 8.1 shows the selected rooms. Table 8.1 gives internal loads and air flow rates used in the simulation of thermal comfort (summer) and indoor air quality (CO₂). Compared to the values used in the annual energy simulations, the load from persons is assumed to be higher, and the air flow rate is adjusted according to the load.



Figure 8.1 Rooms chosen for thermal comfort and indoor air quality simulations at design conditions.

Table 8.1 Internal loads and air flow rates used at design condition for indoor climate simulations.

Internal load and air flow rate	Office landscape	Office cell	Internal meeting room
Person load	12 persons (5 m ² /pers), 6 hours occupation per day ¹	1 person (9 m ² /pers), 6 hours occupation per day	12 persons (2 m ² /pers), 6 hours occupation per day ²
Lighting load	3 W/m ² average in the 12 hours of operation	3 W/m ² average in the 12 hours of operation	3 W/m ² average in the 12 hours of operation
Appliances load	4 W/m ² average in the 12 hours of operation	4 W/m ² average in the 12 hours of operation	4 W/m ² average in the 12 hours of operation
Air flow rate at design summer conditions	9 m ³ /hm ² , diurnal operation	7 m ³ /hm ² , diurnal operation	15 m ³ /hm ² , diurnal operation
Air flow rate at design winter conditions	4,5 m ³ /hm ² in operating hours, 0,7 m ³ /hm ² outside	3,5 m ³ /hm ² in operating hours, 0,7 m ³ /hm ² outside	12 m ³ /hm ² in operating hours, 0,7 m ³ /hm ² outside

¹ This is the mean value, but it is based on that 9 people are present during core time of the working day (9.00-15.00), and 3-4 persons is working between 8.00-9.00 and 15.00-20.00. Assuming 80 W/pers, this gives a mean heat load from person of 8.25 W/m².

² This is the average value, but it is based on the assumption that on average nine people are using it during core time of the working day (9.00-15.00), and 3 persons is using the meeting room between 8.00-9.00 and 15.00-20.00. Assuming 80 W/pers, this gives a mean heat load from person of 20.9 W/m².

8.1 Thermal comfort in summer

8.1.1 Office landscape

With a constant diurnal operation of the ventilation ($9 \text{ m}^3/\text{hm}^2$), adding some night cooling effect, satisfactory temperatures are achieved in the open plan offices under summer design conditions¹². The maximum operative temperature is calculated to be $25.1 \text{ }^\circ\text{C}$.

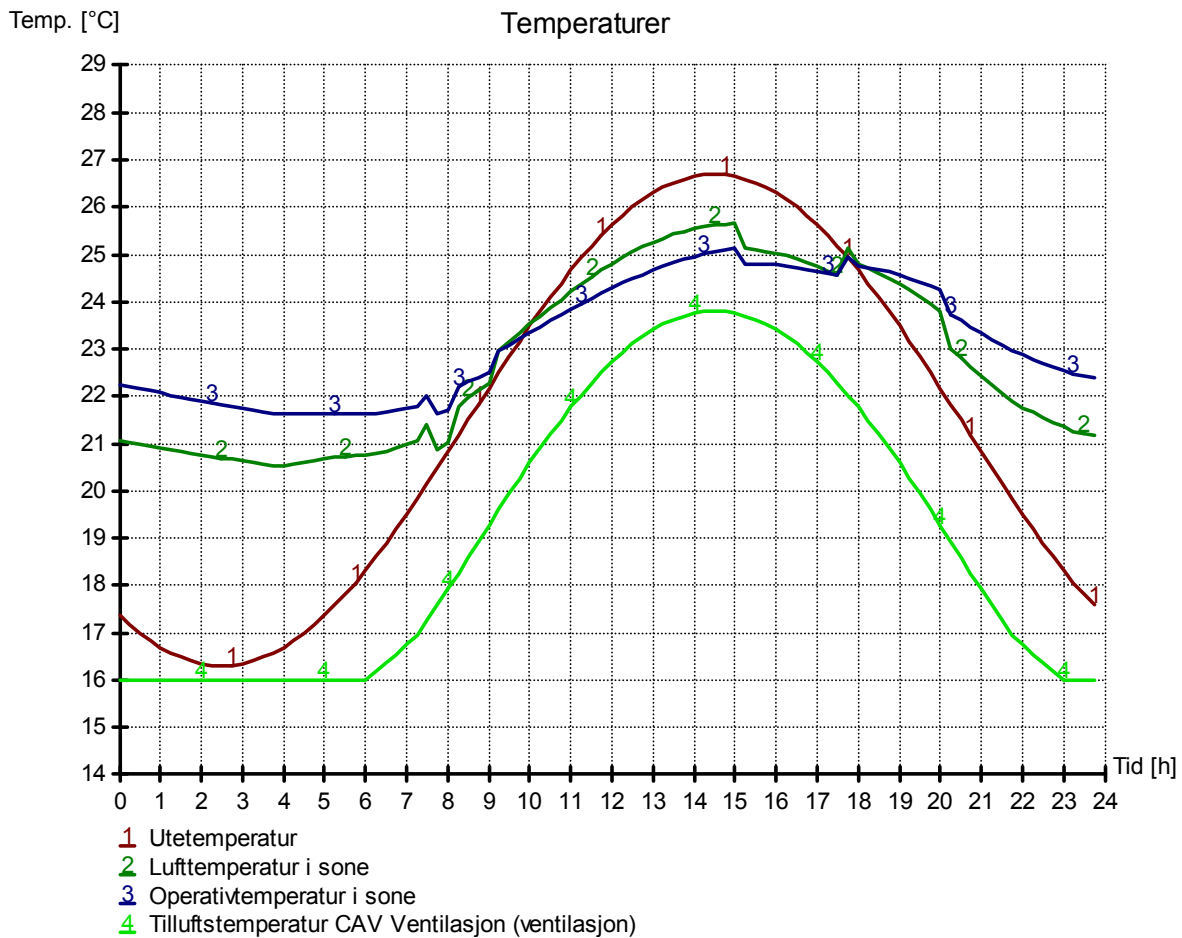

Figure 8.2 Calculated temperatures in a typical open plan office during summer design conditions.

¹² There exist no Norwegian standard for how thermal summer comfort shall be calculated. Here we have used the external temperature that is exceeded 50 hours in a normal year ($26.7 \text{ }^\circ\text{C}$ for Oslo), and added a typical daily temperature amplitude. This condition is simulated as a heat wave of five days in a row, with clear sky radiation.

8.1.2 South facing office cell

With a constant diurnal operation of 7 m³/hm², a satisfactory temperature level is achieved in the office cell. The maximum operative temperature is calculated to be 25.2 °C.

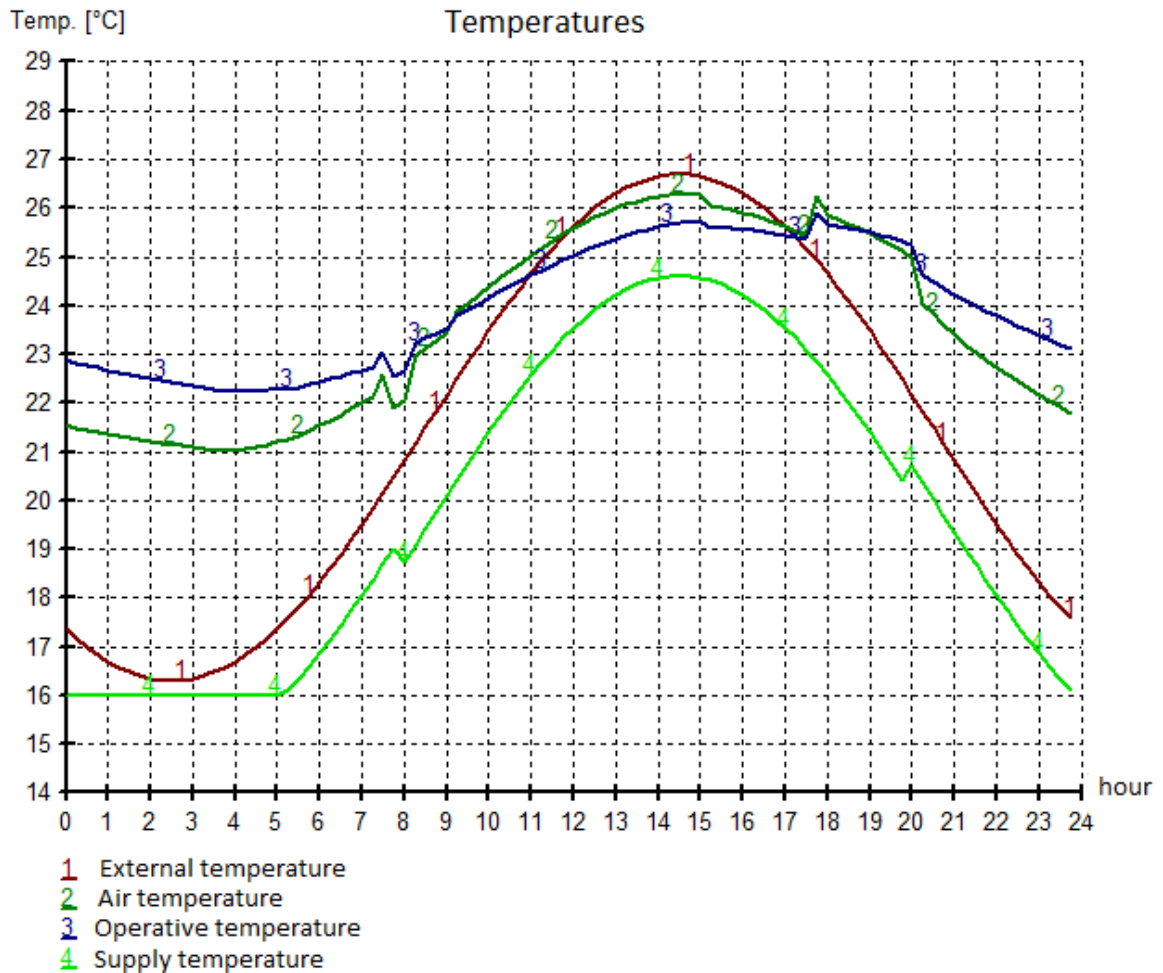

Figure 8.3 Calculated temperatures in a typical south facing office cell during summer design conditions.

8.1.3 Internal meeting room

With a constant diurnal air flow rate of 15 m³/hm², satisfactory temperature levels are also met in the internal meeting room. The maximum operative temperature is calculated to be 25.2 °C.

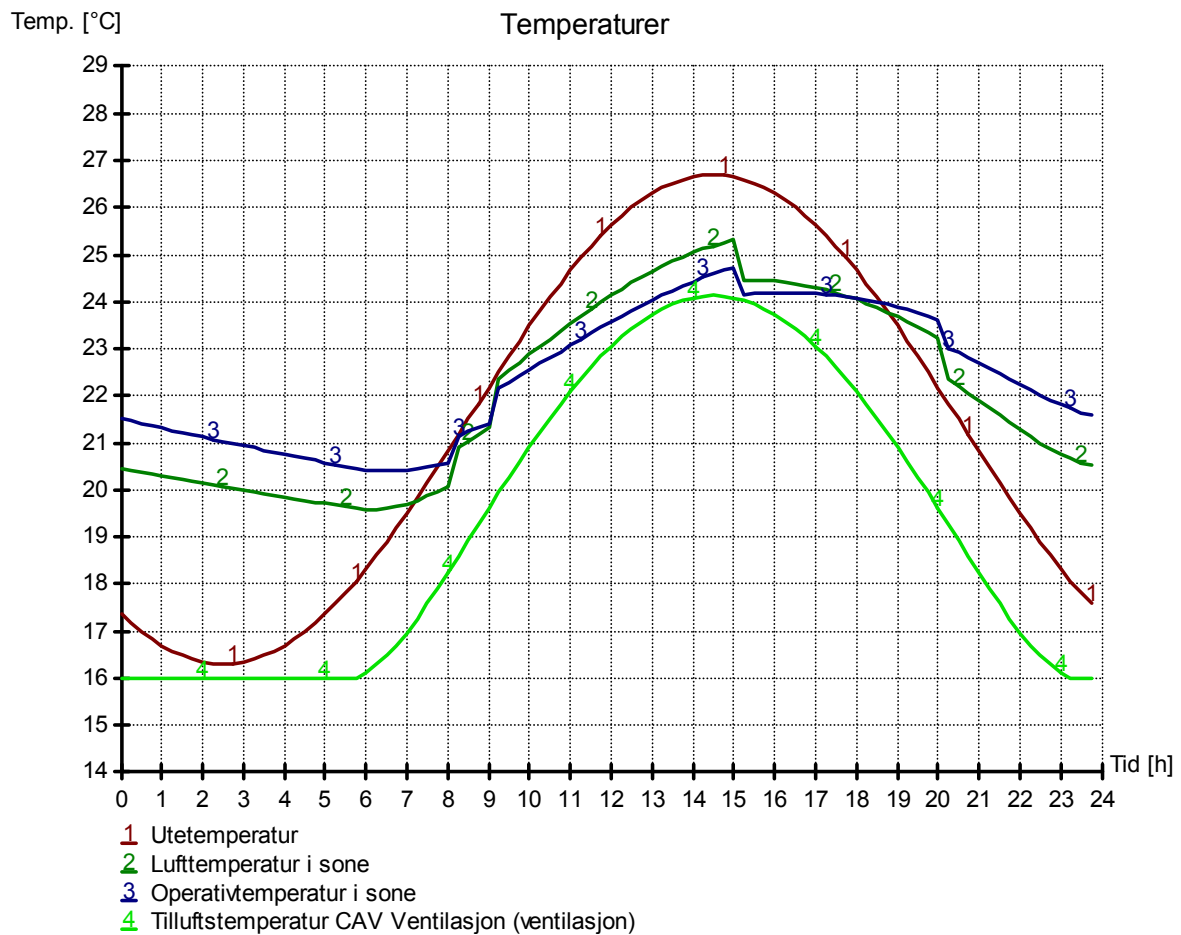

Figure 8.4 Calculated temperatures in an internal meeting room, with a capacity of 12 people, during summer design conditions.

8.2 Air quality

8.2.1 Office landscape

In summer, when air flow rates are determined by required thermal comfort, air quality is generally good, with CO₂ levels in the range 500 – 700 PPM. In winter, reducing the air flow rate towards 4.5 m³/hm² is the most critical. Figure 8.5 shows the CO₂ levels during a day with 4.5 m³/hm². The maximum CO₂ level is 950 PPM. This is a satisfactory level when the temperature is close to 20-21 °C, as it is in the coldest periods of the winter.

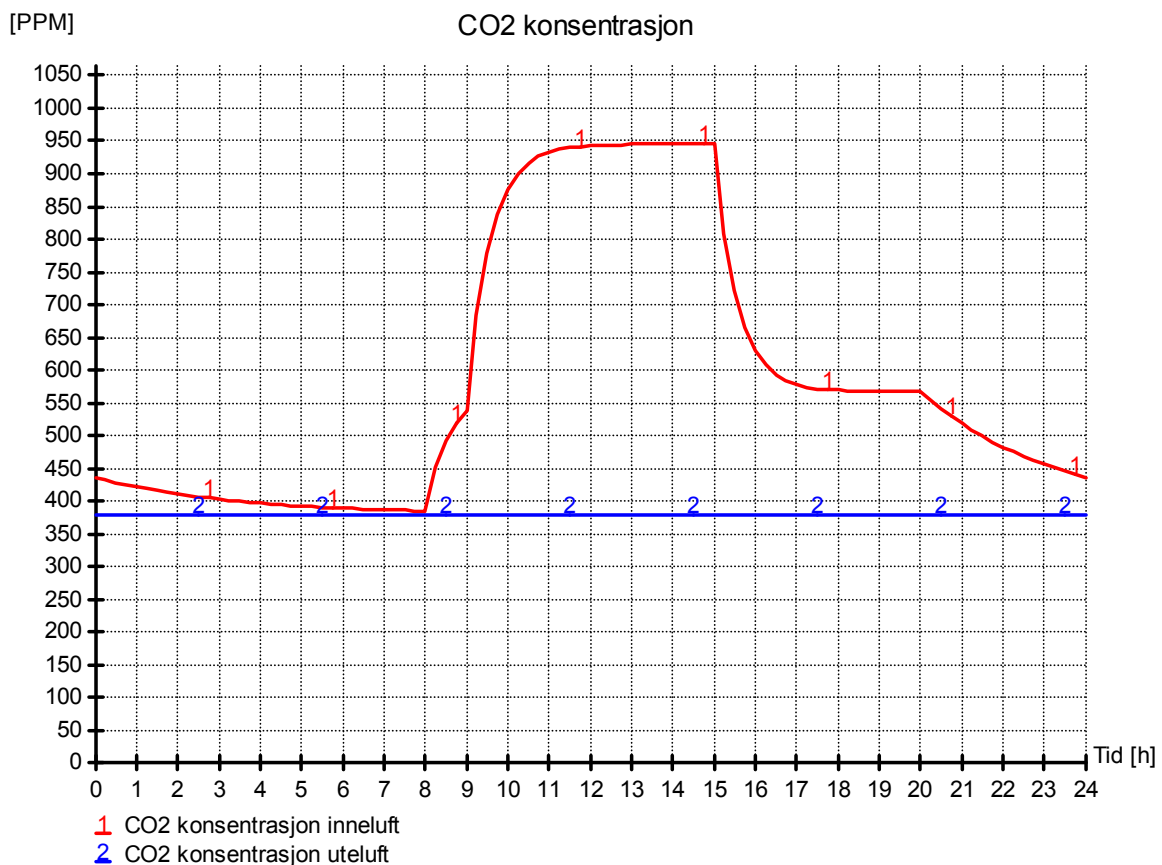

Figure 8.5 Calculated CO₂ levels in a typical open plan office during winter conditions, with a "low" air flow rate (4.5 m³/hm²).

8.2.2 Office cell

Due to the low load density of persons in office cells, the air flow rate can be reduced towards 3.5 m³/hm² in the winter when the temperature is close to 20-21 °C. Figure 8.6 shows the CO₂ levels in the office cell, where the maximum CO₂ level is 900 PPM even if the air flow rate is only 3.5 m³/hm².

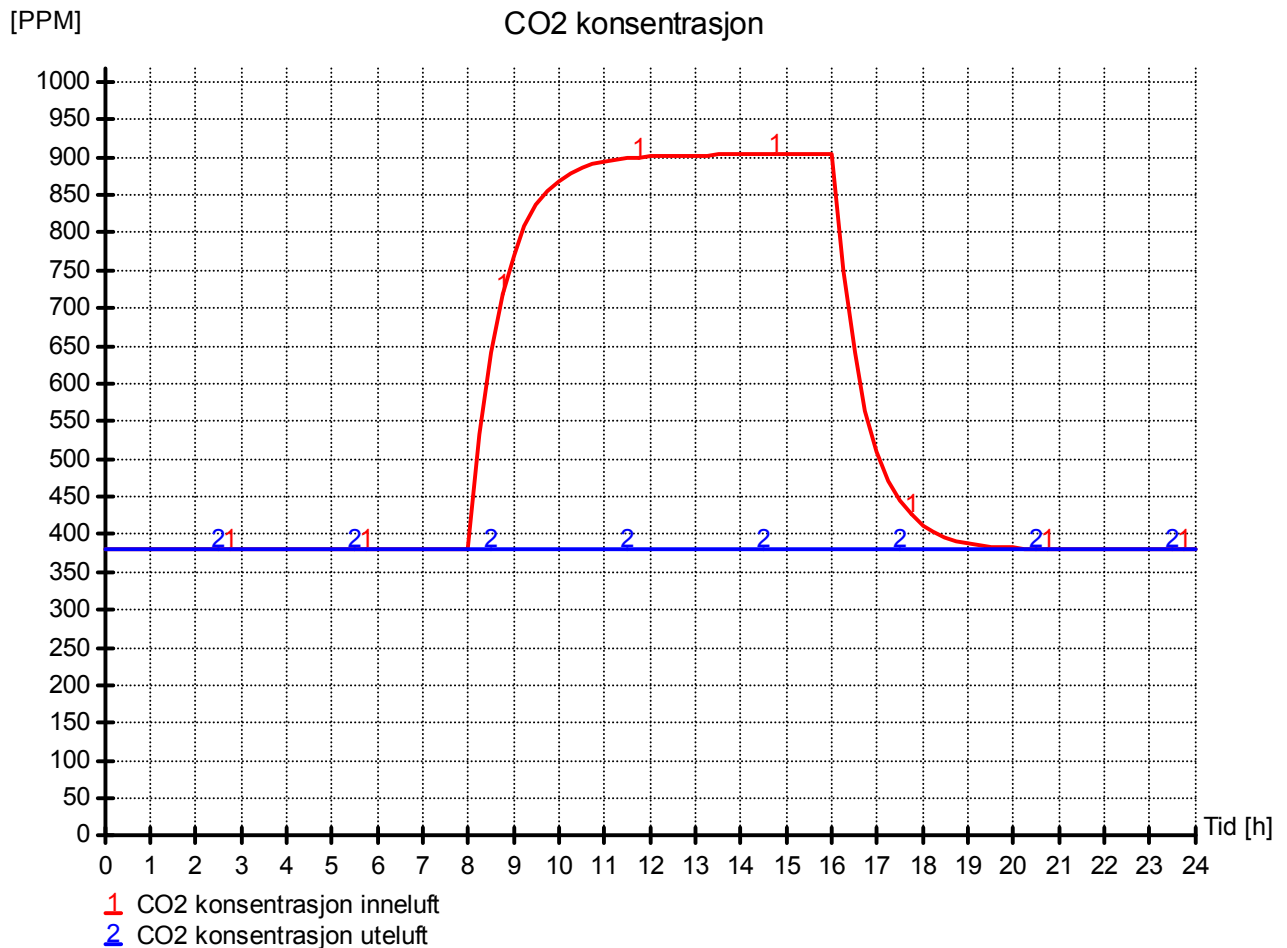

Figure 8.6 Calculated CO₂ levels in a typical office cell during winter conditions, with a "low" air flow rate (3.5 m³/hm²).

8.2.3 Internal meeting room

In the winter time the air flow rate is reduced towards 12 m³/hm². Figure 8.3 shows the CO₂ levels during a day with 12 m³/hm². The maximum CO₂ level is approx. 930 PPM. This is a satisfactory level when the temperature is close to 20-21 °C.

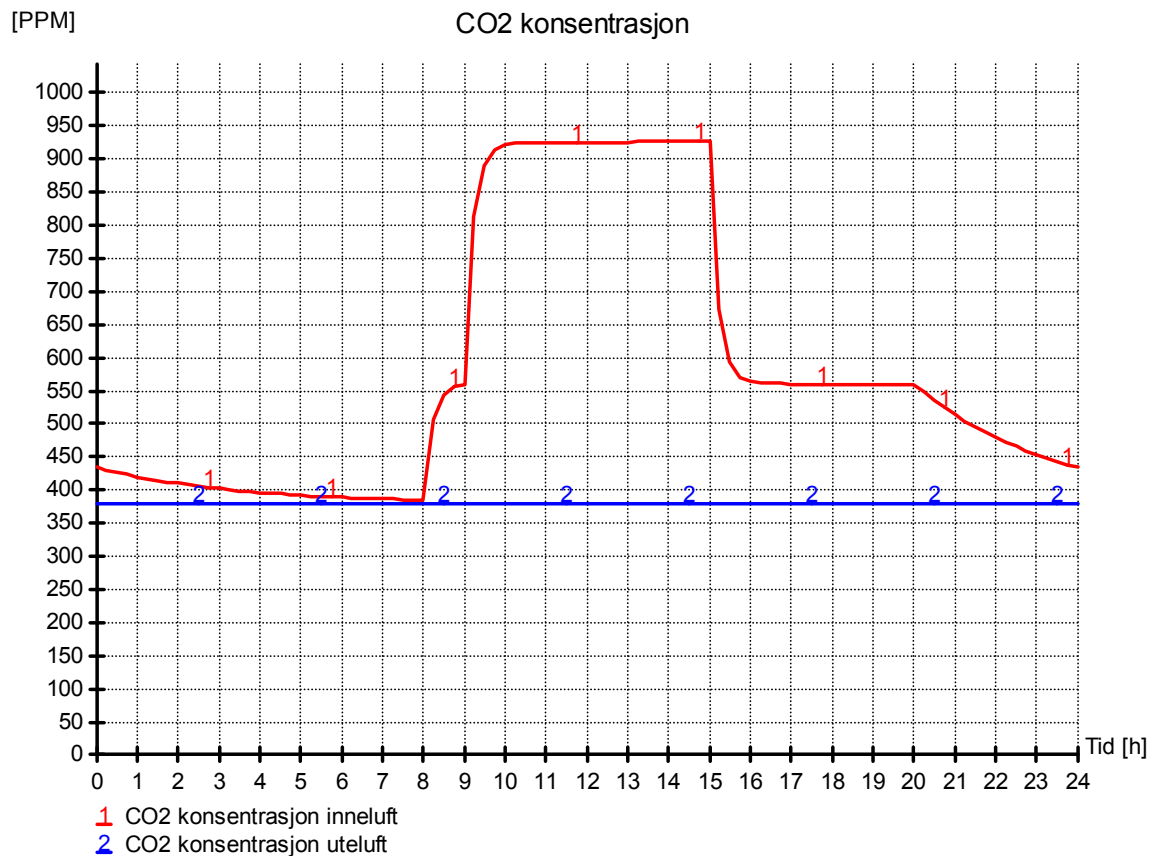

Figure 8.7 Calculated CO₂ levels in an internal meeting room with a capacity of 12 people, during winter conditions with a "low" air flow rate (12 m³/hm²).

9. Discussion, preliminary conclusions, and further work

9.1 Discussion

The aim of this study was to see if it is possible to achieve an "all-electric" ZEB-building by balancing operational- and embodied emissions by PV-production on the building. The conventional and obvious way is to use the roof for PV panels. As calculated in paragraph 7.6 this is only balancing half of the emission (34 %), even if it turns the building into a zero energy office building on an annual basis, and also satisfies the ZEB-O level (see paragraph 1.5).

Using all available area on the south façade for PV, we balance half of the emission (50 %). There are mainly five possible ways to close this 50 % gap:

1. Reduce the (net) energy demand
2. Increase the efficiency of the thermal system, by increasing the COP of the heat supply system¹³.
3. Reduce the embodied emissions.
4. Increase the PV-production.
5. Exploit other on-site electricity producing solutions, such as "building integrated" wind generators.

Even if the net energy demand is already very low, both heating-, cooling and el-specific energy demand can be reduced further. Super insulated windows with extremely low U-values, very efficient heat exchangers, ventilation systems with extremely low fan powers (SFP), passive measures to reduce or eliminate cooling demand, and very energy efficient lighting can be measures to reduce the demand further.

Combined and optimized solar, heat pump and cooling systems (often using the ground as source) with very high annual COP (SPF¹⁴) may reduce the delivered electricity used to run the thermal system. There is probably a large potential to raise the COP/SPF considerably compared to the values used in this study.

There is probably a large potential to reduce the embodied emissions for building materials and installations. No effort has been made to optimize the materials used in the building; only conventional materials and solutions have been used. On the other hand; more accurate methods, data for materials, and material inventories may also lead to increased CO₂ emissions.

There are several ways to increase the solar electricity production from PV panels - for example by optimizing the roof form and orientation so that large areas with optimum orientation can be used for PV panels or by using also other facades, such as east and west facing facades, even if the solar yield is lower. PV panels with higher annual efficiency will of course also increase the production.

Other on-site electricity production units, such as building integrated wind generators, can be an interesting solution to increase the total production. But, problems like local turbulence, "wind shadows", noise and vibrations have to be solved in a convincing way before building integrated wind can be a real alternative or supplement to PV. This was also the conclusion in the Powerhouse One project \19\.

¹³ Could also take into account the cooling system, but in this case it has already a high COP for the cooling. An even higher COP will only have a marginal effect on delivered electricity.

¹⁴ SFP: Seasonal Performance Factor, can either be calculated/simulated and/or measured.

9.2 Preliminary conclusion

The preliminary conclusions from this study are:

1. For a typical medium rise office building (4 storeys) it is rather easy to achieve a ZEB-O¹⁵ level, which in this case¹⁶ can be labeled a zero energy office building (energy produced on-site with PV equals total electricity demand).
2. Taking into account also the embodied emissions from materials and installations it seems very difficult to achieve the ZEB-OM (operation and material, see section 1.5) level. The calculation is based on using areas with "acceptable" solar yield, namely the roof and the south (long) façade.
3. Even if the calculation of embodied emissions (EE) has considerable uncertainties, preliminary results indicate that EE is considerable higher than the emission related to energy use for operation. However, in the calculations reported here no effort has been made to reduce EE, in contrast to the energy use for operation, where high performance solutions have been used.
4. To achieve a ZEB-OM level a combination of further reduced energy demand, high COP/SPF thermal systems, reduced embodied emissions and increased PV-production seems to be the solution.

This study does not consider other on-site electricity production alternatives, such as bio-CHP¹⁷ or building integrated wind generators. This study is also restricted to analyze operation and embodied emission, not taking into account emissions related to the construction process (see ZEB-COM level, paragraph 1.5).

9.3 Further work

Based on the analysis in this report, some of the issues that need more detailed work are given below. In some cases explicit goals for system or component performance are proposed.

- Analyze in detail how the heating system can be simplified by using the ventilation system for both heating and cooling. **Goal: Ventilation system solution covering both cooling and heating, with a heating coil power demand < 20 W/m².** Good air quality and thermal comfort have to be achieved in all rooms/zones in the building.
- Analyze what is an optimal level of thermal mass in such a high performance building, especially in cases where night cooling and/or "night heating" (see par. 4.2) is used. Acoustic environment has to be taking into account in such a study.
- Analyze how low one can reduce the energy demand for lighting and appliances, without sacrificing good indoor climate (lighting conditions) and functionality. **Goal: 5-7 kWh/m²a for lighting and 10 kWh/m²a for appliances.**
- Analyze how a ventilation system with very low fan power (SFP) and very high heat recovery rate can be designed. **Goal: SFP < 0.5 kW/(m³/s) and $\eta \geq 90$ %.**

¹⁵ Zero Emission Building in operation, see paragraph 1.5 for details.

¹⁶ The analyses in this report are restricted to "all electric" buildings, meaning that heating and cooling is provided by heat pump/cooling machines and/or solar system, which "transforms" the thermal demand into (a lower) electric demand. And this electric demand is met by on-site renewables as PV and/or wind generators.

¹⁷ Bio-CHP: Combined heat and power units producing both heat and electricity, using some kind of bio-fuel (solid, fluid or gas).

- Analyze how high performance windows with very low U-value, high g-value and high light transmittance can be designed. **Goal: $U \leq 0.55 \text{ W/m}^2\text{K}$, $g \geq 0,45$, $LT \geq 65 \%$.**
- Analyze how an optimal thermal system should be designed, e.g. how a combined solar thermal and geothermal heat pump/cooling system should be designed. **Goal: Annual system COP for thermal heat system: $\text{COP}_h > 5.0$, annual system COP cooling: $\text{COP} > 30$.**
- Working to improve data, methods and material inventories for more accurate embodied emission calculations. Making it possible to make reliable tools for optimization of material use to minimize embodied emission. **Goal: Embodied emission $< 5.0 \text{ kg/m}^2\text{a}$.**
- Analyze other solutions for on-site electricity production, such as bio-CHP solutions, low-carbon solutions or building integrated or on-site wind generators.
- Analyze and develop methods and tools for taking into account emissions due to the construction process.

10. References

- \1\ NS3701:2012 Criteria for passive houses and low energy buildings – Non-residential buildings. Standard Norway 2012.
- \2\ Revit Architecture Suite version 2011.
(<http://www.autodesk.no/adsk/servlet/pc/index?siteID=446819&id=14609041>)
- \3\ SimaPro version 7.3. (http://www.misa.no/software/simapro_lca_verktoey/)
- \4\ EcolInvent version 2.2. (<http://www.ecoinvent.ch/>)
- \5\ SIMIEN 5.11, SIMulation of Indoor climate and ENergy use. www.programbyggerne.no
- \6\ http://www.ecocalc.com/manufacturer_col/1200/Conergy+AG/Xinox+HP20?ep=1&prid=
- \7\ Polysun 5.1 Simulation Software. Velasolaris AG. www.velasolaris.com
- \8\ PV-syst 5.62 Photovoltaic System Software. <http://www.pvsyst.com/en/>
- \9\ Arge, K. Generalitet, fleksibilitet og elastisitet i kontorbygninger. Hvilke typer tilpasningsdyktighet bør norske byggherrer velge, og hva velger de?, Prosjektrapport 340. Oslo, 2003.
- \10\ Uvsløkk S., Time B., Jelle B.P., "Emerging envelope solutions suitable for ZEBs – optimization of envelopes", Lecture notes for PhD course in ZEB at NTNU, Trondheim October 2012.
- \11\ NS3031:2007 Calculation of energy performance of buildings Method and data.
- \12\ Byggforskserien 523.701 Innsetting av vindu i vegger av bindingsverk 2012.
- \13\ Gustavsen A., Thue J.V., Blom P., Dalehaug A., Aurlien T., Grynning S., Uvsløkk S., "Kuldebroer – Beregning, kuldebroverdier og innvirkning på energibruk" SINTEF Byggforsk Prosjektrapport 25, 2008.
- \14\ Dokka T.H., Svensson A., Wigenstad T., Andresen I., Simonsen I., Berg T.F., "Energibruk i bygninger - Nasjonal database og sammenligning av beregnet og målt energibruk", Prosjektrapport 76, SINTEF Byggforsk, 2011.
- \15\ Grini C., Wigenstad T., "LECO - Behovstilpasset ventilasjon - Hvordan får man alle brikkene på plass?", Prosjektrapport 73, SINTEF Byggforsk, 2011.
- \16\ Dokka T.H., "Faglig underlag for NS 3701:2012 - Kriterier for passivhus- og lavenergibygg-Yrkesbygninger", Prosjektrapport 99, SINTEF Byggforsk, 2012.
- \17\ M. Berg, NLK – Belysningseffekt - Rapport om beregningsforutsetninger og foreslåtte verdier i NS3700., Rapport Lyskultur 2011.
- \18\ Voss K., Musall E., "Net Zero Energy Buildings – International projects of carbon neutrality in buildings"DETAIL Green Books, 2011.

- \19\ Thyholt M., Dokka T.H, Jenssen B., "Powerhouse One: the first plus-energy commercial building in Norway", Proceedings PassivhusNorden 2012, Trondheim. (www.passivhusnorden.no)
- \20\ Snøhetta, Skanska, ZEB, Asplan Viak, Hydro Building System, ZERO, ENTRA, Multiconsult, "Forprosjektrapport Powerhouse Kjørbo – Bærum". Oktober 2012.
<http://powerhouse.no/kjorbo/>
- \21\ Thyholt M., Dokka T.H., "The Skarpnes residential development - a zero energy pilot project", Proceedings PassivhusNorden 2012, Trondheim. (www.passivhusnorden.no)
- \22\ NS3451:2009 Bygningsdelstabellen. (Table of building elements).
- \23\ EN15978: Sustainability of construction works. Assessment of environmental performance of buildings. Calculation method.

APPENDICES

A Embodied emission

In the table below the inventory for the material analysis are given. The underlined processes are processes that have only been included with raw materials extraction.

The construction column refers to the construction part involved and the relevant number from the table of building elements. The lifetime in years is given in column 6 and the source of the environmental data used is given in the column process used.

Construction	Nr.	Material input	Amount	Unit	Lifetime in years	Process used
21 Foundation						
214 <i>Support structures</i>	2141	Reinforcement steel	20237,3	kg	60	Reinforcing steel, at plant/RER U ZEB
216 <i>Direct foundation</i>	2161	Reinforcement steel	7800,0	kg	60	Reinforcing steel, at plant/RER U ZEB
	2162	Concrete	104,0	m3	60	Concrete, normal, at plant/CH U ZEB and with- EPD Standard: Norcem
22 Bearing constructions						
222 <i>Columns</i>	2221	Reinforcement steel	10110,8	kg	60	Reinforcing steel, at plant/RER U ZEB
	2222	Concrete	3,2	m3	60	Concrete, normal, at plant/CH U ZEB and with- EPD Standard: Norcem
223 <i>Beams</i>	2231	Reinforcement steel	22529,5	kg	60	Reinforcing steel, at plant/RER U ZEB
23 Outer walls						
231 <i>Bearing outer wall</i>	2311	Timber	15684,4	kg	60	Plywood, outdoor use, at plant/RER U and Høvellast, EPDnr 84 tot.
231 <i>Bearing outer wall -basement</i>	2312	Concrete	109,0	m3	60	Concrete, normal, at plant/CH U ZEB and with- EPD Standard: Norcem
231 <i>Bearing outer wall- basement</i>	2313	Reinforcement steel	8175,0	kg	60	Reinforcing steel, at plant/RER U ZEB
232 <i>Non Bearing outer walls</i>	2321	Gypsum plates outer	7334,9	kg	60	Gypsum plaster board, at plant/CH U ZEB and Norgips EPD
	2322	Insulation	5252,2	kg	60	Glass wool mat, at plant/CH U ZEB and Glava EPD
	2323	Vapour barrier	124,0	kg	60	<u>Polyethylene, LDPE, granulate, at plant/RER U</u>
234 <i>Windows</i>	2341	Triple glazing	397,5	m2	30	Glazing, triple (3-IV), U<0.5 W/m2K, at plant/RER U ZEB
	2342	Aluminium frame	8,4	m2	60	Window frame, aluminium, U=1.6 W/m2K, at plant/RER U ZEB
	2343	Outer doors	12,0	m2	30	Door, outer, wood-aluminium, at plant/RER U
235 <i>Facade material</i>	2351	Cembrit fiber cem.	12087,0	kg	30	EPD- Cembrit Etna True- Fiber cement To gate - Finland - 2012
236 <i>Inner surface</i>	2361	Gypsum plates inner	7326,6	kg	30	Gypsum plaster board, at plant/CH U ZEB and Norgips EPD
237 <i>Sun Screening</i>	2371	Aluminium	2764,7	kg	30	<u>Aluminium, production mix, at plant/RER U m ZEB</u>
24 Inner walls						
241 <i>Bearing inner walls</i>	2411	Concrete	134,0	m3	60	Concrete, normal, at plant/CH U ZEB and with- EPD Standard: Norcem
	2412	Reinforcement steel	8251,7	kg	60	Reinforcing steel, at plant/RER U ZEB
242 <i>Non bearing inner walls</i>	2421	Insulation	1910,3	kg	30	Glass wool mat, at plant/CH U ZEB and Glava EPD
	2422	Gypsum plates	49011,4	kg	30	Gypsum plaster board, at plant/CH U ZEB and Norgips EPD
	2423	Steel studs	1004,5	kg	30	<u>Steel, low-alloyed, at plant/RER U ZEB</u>
	2424	Zink coating	41,9	m2	30	Zinc coating, pieces/RER U
	-	Aluminium -Rist	9423,0	kg	60	<u>Aluminium, production mix, at plant/RER U m ZEB</u>

Construction	Nr.	Material input	Amount	Unit	Lifetime in years	Process used
	-	Wood veneers	4.2	m ³	60	<i>Plywood, outdoor use, at plant/RER U og Høvellast EPD</i>
243 Systemwalls /glass walls	2431	Timber - office front	2 313.0	kg	30	<i>Plywood, indoor use, at plant/RER U og Høvellast EPD</i>
	2432	Glass	3 167.4	kg	30	Flat glass, coated, at plant/RER U
244 Windows and doors	2441	Steel	12 870.0	kg	30	<i>Steel, low-alloyed, at plant/RER U ZEB</i>
	2442	Timber doors	92.0	m ²	30	Door, inner, wood, at plant/RER U
25 Slabstructures						
251 Slabstructures	2511	Concrete	467.0	m ³	60	Concrete, normal, at plant/CH U ZEB and with- EPD Standard: Norcem
	2512	Reinforcement steel	1 4010.0	kg	60	Reinforcing steel, at plant/RER U ZEB
252 Foundation flooring	2521	Membrane	70.0	kg	60	<i>Polyethylene, LDPE, granulate, at plant/RER U</i>
	2522	Insulation	2 905.0	kg	60	Glass wool mat, at plant/CH U ZEB and Glava EPD
253 Concrete for equalization	2531	Concrete	56.9	m ³	60	Concrete, normal, at plant/CH U ZEB and with- EPD Standard: Norcem
254 Floor systems	2541	Vinyl	546.0	kg	15	Homogenous Vinyl http://www.erfmi.com Manufacturing
	2542	Linoleum	2859.8	kg	15	Linoleum http://www.erfmi.com/ EPD database - manufacture
	2543	Laminate	273.0	m ²	15	Laminate flooring EGGER Flooring EPD 2011
	2544	Carpet	165.6	kg	15	Carpet- EPD-BauUmwelt Desso - 100 % PA6 fra nov. 2011
257 Ceilings- System	2571	Insulation	5 496.7	kg	60	Glass wool mat, at plant/CH U ZEB and Glava EPD
	2572	Gypsum	27 359.8	kg	60	Gypsum plaster board, at plant/CH U ZEB and Norgips EPD
	2573	Steel studs	2 228.4	kg	60	<i>Steel, low-alloyed, at plant/RER U ZEB</i>
	2574	Zink coating	185.7	m ²	60	Zinc coating, pieces/RER U
26 Outer roof						
261 Primary construction	2611	Insulation	3 735.0	kg	60	Glass wool mat, at plant/CH U ZEB and Glava EPD
	2612	Membrane	2 500.0	kg	30	Bitumen sealing V60, at plant/RER U ZEB
28 Stairs -balconies						
281 Inner stairs	2811	Concrete and steel	22 356.0	kg	60	Based on EPD- stairs element -NorElement <i>Portland cement, strength class Z 42.5 and Reinforcement steel</i>
282 Outer stairs	2821	Steel	500	kg	60	<i>Steel, low-alloyed, at plant/RER U ZEB</i>
29 Other						
29 Elevator from Kone	291	Mixed inputs	2848,0	kg	30	Fraunhofer LCA analysis
30 VVS Systems						
325 Solar thermal collectors	3251	Vacuum tube	25.0	m ²	20	Evacuated tube collector, at plant/GB/I U
	3252	Aluminium	32.2	kg	20	<i>Aluminium, production mix, cast alloy, at plant/RER U</i>
36 Ventilation air estimate	361	Mixed inputs	1.0	piece	60	<i>Steel, aluminium, copper, plastics (aggregate 20 years lifetime)</i>
40 Electric						
40 Cable bridge	401	Steel	840.0	kg	60	<i>Steel, low-alloyed, at plant/RER U ZEB</i>
	402	Zink coating	35.3	m ²	60	Zinc coating, coils/RER U
40 Cables	403	Cables	3 000.0	m	30	Cable, three-conductor cable, at plant/GLO U
49 Solar Cells	491	Solar cells	686.0	m ²	30	Photovoltaic panel, single-Si, at plant/RER/I U

Density of main material inputs

Material	Density	Unit
Steel	7 850	kg/m ³
Insulation – walls-floor- roof	16.6	kg/m ³
Insulation – for noise reduction	110	kg/m ³
Aluminium	2 300	kg/m ³
Timber	500	kg/m ³
Plastic foil	0.14	kg/m ²
Gypsum plates	850-980	kg/m ³
Concrete	2 380	kg/m ³
Façade plates	1 700	kg/m ³

B Input values energy simulations

Table B.1. Summary of input data for the SIMIEN simulation.

Description	Value
Area external wall [m ²]:	860
Area roof [m ²]:	495
Area floor [m ²]:	495
Area windows and doors m ² :	456
Heated floor area (BRA) [m ²]:	1 980
Heated air volume [m ³]:	5 783
U-value external wall [W/m ² K]	0.12
U-value roof [W/m ² K]	0.09
U-value floor [W/m ² K]	0.11
U-value windows and doors [W/m ² K]	0.75
Area windows and doors divided by heated floor area [%]	23
Normalized thermal bridge value [W/m ² K]:	0.03
Normalized heat capacity [Wh/m ² K]	83
Air leakage (n50) [1/h]:	0.30
Temperature efficiency heat exchanger [%]:	86
Estimated efficiency exchanger adjusted for frost prevention [%]:	86.0
Specific fan power (SFP) [kW/m ³ /s]:	1.00
Air flow rate in operating hours [m ³ /hm ²], heating season	5.5
Air flow rate outside operating hours [m ³ /hm ²], heating season	0.7
Air flow rate in operating hours [m ³ /hm ²], cooling season	7.0
Air flow rate outside operating hours [m ³ /hm ²], cooling season	0.7
System efficiency heating system:	4.0
Installed power capacity room heating and heating coil. [W/m ²]:	15
Setpoint temperature heating, operating hours [°C]	21.0
Setpoint temperature heating, outside operating hours [°C]	19.0
System COP cooling:	25
Installed power capacity cooling coil [W/m ²]:	10
Specific pump power heating [kW/(l/s)]:	0.30
Specific pump power cooling coil [kW/(l/s)]:	0.30
Operating hours ventilation (hours)	12.0
Operating hours lighting (hours)	12.0
Operating hours equipment (hours)	12.0
Occupation hours persons ((hours)	12.0
Power demand and heat load lighting in operating hours [W/m ²]	3.00
Power demand and heat load equipment in operating hours [W/m ²]	4.00
Average power demand DHW on operating days [W/m ²]	0.80
Heat load persons in operating hours [W/m ²]	4.00
Total solar shading factor window and artificial shading:	0.05
Average frame factor windows:	0.20
Shading factor horizon and building extentions:	0.90

C Details from Polysun simulations

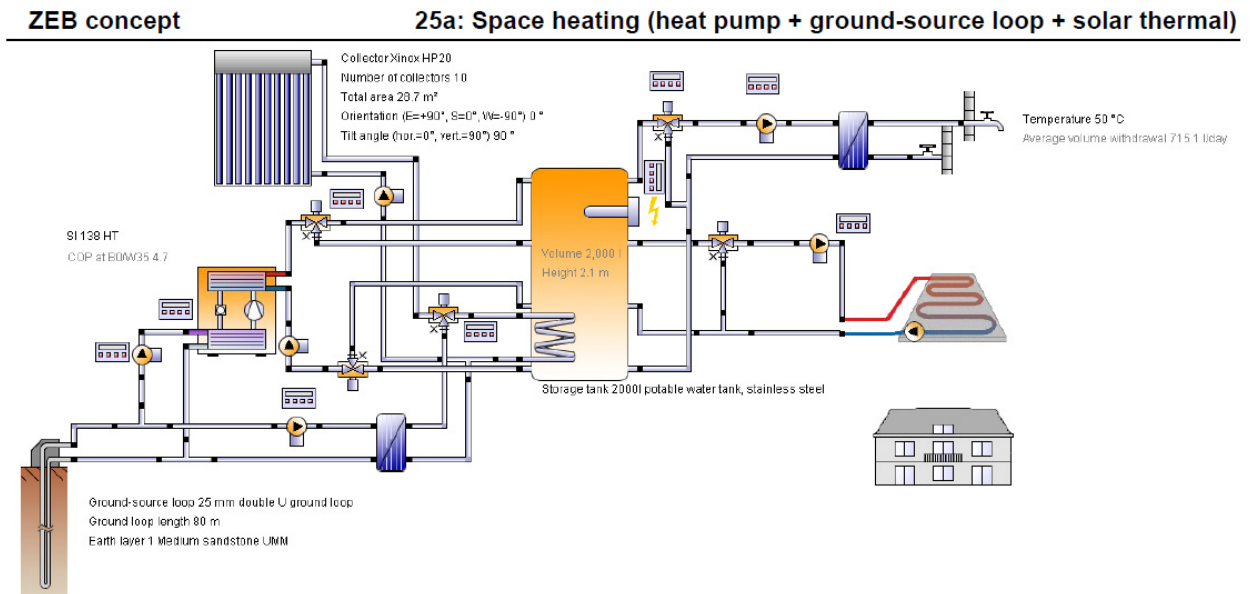

Figure C.1: System schematic of the simulation model in Polysun.

Overview solar thermal energy (annual values)

Collector area	28.7 m ²
Solar fraction total	21.5%
Solar fraction hot water [SFnHw]	42.4 %
Solar fraction building [SFnBd]	9.6 %
Total annual field yield	10,304.5 kWh
Collector field yield relating to gross area	359 kWh/m ² /Year
Collector field yield relating to aperture area	487.7 kWh/m ² /Year
Max. energy savings	3,120.1 kWh
Max. reduction in CO ₂ emissions	1,673.6 kg

Overview heat pump (annual values)

Seasonal performance factor (without pump energy)	3.3
Total electrical energy consumption when heating [Eaux]	11,412.6 kWh
Ground loop length (Total)	80 m
Energy withdrawal of the ground-source loop	25,763.2 kWh
Total energy savings	26,278.6 kWh
Total reduction in CO ₂ emissions	14,095.9 kg

Figure C.2 Excerpt from the results from the Polysun simulation.

Year	Jan	Feb	Mar	Apr	May	Jun	Jul	Aug	Sep	Oct	Nov	Dec	
Solar thermal energy to the system [Qsol]													
kWh	10305	462	844	1164	956	1029	925	999	1139	1147	871	502	267
Heat generator energy to the system (solar thermal energy not included) [Qaux]													
kWh	37691	8286	6810	5606	1057	505	452	347	364	256	1269	4664	8075
Heat generator fuel and electrical energy consumption [Eaux]													
kWh	11413	2506	2062	1693	323	157	139	111	116	81	381	1402	2440
Solar fraction: fraction of solar energy to system [SFn]													
%	21.5	5.3	11	17.2	47.5	67.1	67.2	74.2	75.8	81.7	40.7	9.7	3.2
Total fuel and/or electrical energy consumption of the system [Etot]													
kWh	12116	2647	2188	1804	345	170	150	123	128	92	405	1487	2578
Irradiation onto collector area [Esol]													
kWh	20263	889	1532	2182	1944	2211	2072	2096	2183	2058	1588	929	578
Electrical energy consumption of pumps [Epar]													
kWh	704	141	126	110	22	13	11	11	12	11	24	85	139
Heat loss to indoor room (including heat generator losses) [Qint]													
kWh	2317	252	233	236	154	163	163	168	171	159	172	199	248
Heat loss to surroundings (without collector losses) [Qext]													
kWh	209	14	20	23	20	21	19	18	17	18	18	13	10
Total energy consumption [Quse]													
kWh	45582	8602	7514	6591	1895	1304	1129	1145	1170	1035	1989	5000	8210

Figure C.3 Excerpt from the results from the Polysun simulation.

COMMENT: Polysun calculates the space heating load and the DHW load in another way than SIMIEN does, which has been used to calculate the energy use and indoor climate in this report. This gives somewhat different monthly load for space heating and DHW than SIMIEN, but gives quite close match for annual load. However, this gives for example different solar fraction for the solar thermal system, when we use the thermal load from SIMIEN. Due to lower load in the summer months, the solar thermal energy to the system is reduced from 10 305 to 9 208 kWh per year. Which also, to some degree, will affect how much of the thermal load the heat pump system has to cover. The results given in this appendix will therefore deviate somewhat with the result presented in chapter 7, which is based on the SIMIEN simulations.

D Details PV-syst simulations

D.1 Results south facing panels on the roof

PVSYST V5.56	Sintef Building and Infrastructure	20/11/12	Page 1/4
ZEB WP5 concept - office			
Grid-Connected System: Simulation parameters			
Project :	Grid-Connected Project at Oslo		
Geographical Site	Oslo	Country	Norway
Situation	Latitude 59.5°N	Longitude	10.4°E
Time defined as	Legal Time Time zone UT+1	Altitude	5 m
	Albedo 0.20		
Meteo data :	Oslo, Synthetic Hourly data		
Simulation variant :	office 3 rows - south		
	Simulation date	20/11/12 14h21	
Simulation parameters			
Collector Plane Orientation	Tilt 10°	Azimuth	0°
Horizon	Free Horizon		
Near Shadings	Linear shadings		
PV Array Characteristics			
PV module	Si-mono	Model	SPR-333NE-WHT-D
		Manufacturer	SunPower
Number of PV modules	In series	5 modules	In parallel 29 strings
Total number of PV modules	Nb. modules	145	Unit Nom. Power 333 Wp
Array global power	Nominal (STC)	48.3 kWp	At operating cond. 43.6 kWp (50°C)
Array operating characteristics (50°C)	U mpp	244 V	I mpp 179 A
Total area	Module area	236 m²	Cell area 213 m²
Inverter			
	Model	Sunny Boy SB 1700	
	Manufacturer	SMA	
Characteristics	Operating Voltage	139-320 V	Unit Nom. Power 1.55 kW AC
Inverter pack	Number of Inverter	29 units	Total Power 44.95 kW AC
PV Array loss factors			
Thermal Loss factor	Uc (const)	20.0 W/m²K	Uv (wind) 0.0 W/m²K / m/s
=> Nominal Oper. Coll. Temp. (G=800 W/m², Tamb=20°C, Wind=1 m/s.)			NOCT 56 °C
Wiring Ohmic Loss	Global array res.	23 mOhm	Loss Fraction 1.5 % at STC
Module Quality Loss			Loss Fraction 2.5 %
Module Mismatch Losses			Loss Fraction 2.0 % at MPP
Incidence effect, ASHRAE parametrization	IAM =	1 - bo (1/cos i - 1)	bo Parameter 0.05
User's needs :	Unlimited load (grid)		

ZEB WP5 concept - office

Grid-Connected System: Near shading definition

Project : Grid-Connected Project at Oslo
Simulation variant : office 3 rows - south

Main system parameters	System type	Grid-Connected		
Near Shadings	Linear shadings			
PV Field Orientation	tilt	10°	azimuth	0°
PV modules	Model	SPR-333NE-WHT-D	Pnom	333 Wp
PV Array	Nb. of modules	145	Pnom total	48.3 kWp
Inverter	Model	Sunny Boy SB 1700	Pnom	1550 W ac
Inverter pack	Nb. of units	29.0	Pnom total	45.0 kW ac
User's needs	Unlimited load (grid)			

Perspective of the PV-field and surrounding shading scene

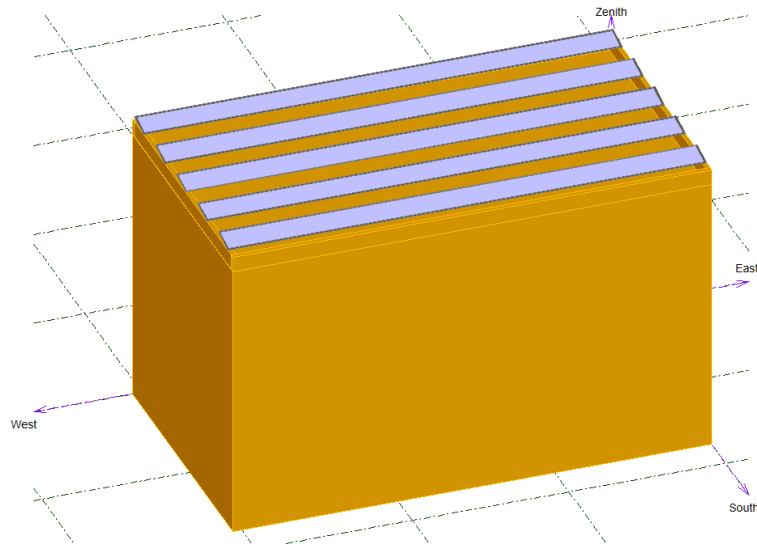

Iso-shadings diagram

Grid-Connected Project at Oslo: Office Option1 - 10deg 3 rows

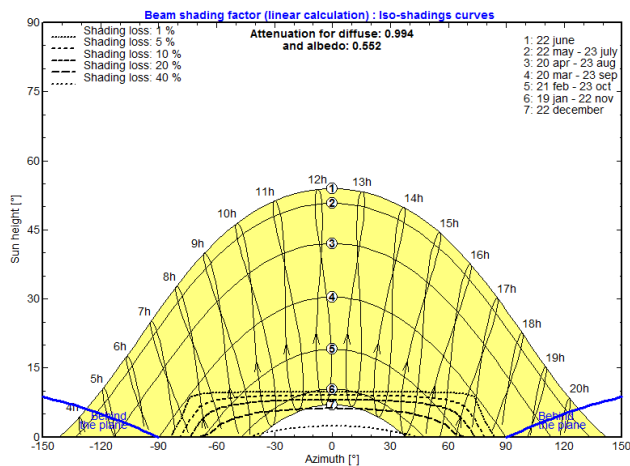

ZEB WP5 concept - office

Grid-Connected System: Main results

Project : Grid-Connected Project at Oslo

Simulation variant : office 3 rows - south

Main system parameters	System type	Grid-Connected	
Near Shadings	Linear shadings		
PV Field Orientation	tilt	10°	azimuth 0°
PV modules	Model	SPR-333NE-WHT-D	Pnom 333 Wp
PV Array	Nb. of modules	145	Pnom total 48.3 kWp
Inverter	Model	Sunny Boy SB 1700	Pnom 1550 W ac
Inverter pack	Nb. of units	29.0	Pnom total 45.0 kW ac
User's needs	Unlimited load (grid)		

Main simulation results	Produced Energy	40211 kWh/year	Specific prod. 833 kWh/kWp/year
System Production	Performance Ratio PR	77.4 %	

Normalized productions (per installed kWp): Nominal power 48.3 kWp

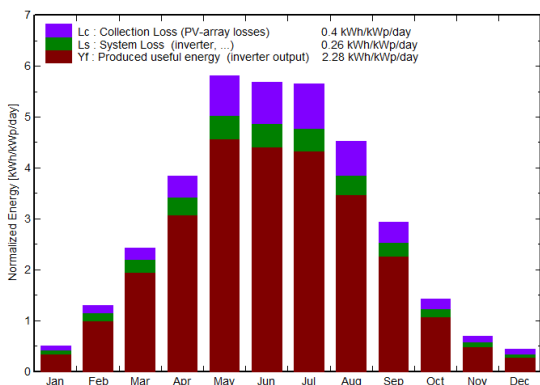

Performance Ratio PR

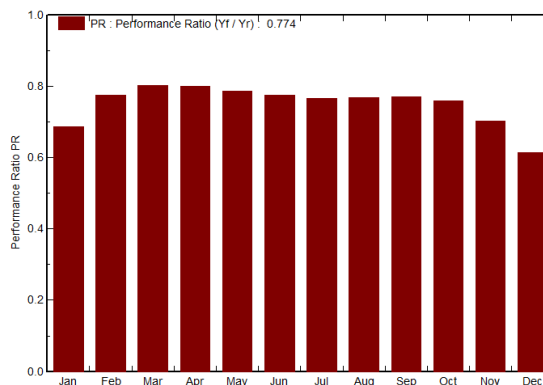

office 3 rows - south

Balances and main results

	GlobHor	T Amb	GlobInc	GlobEff	EArray	E_Grid	EffArrR	EffSysR
	kWh/m ²	°C	kWh/m ²	kWh/m ²	kWh	kWh	%	%
January	11.0	-1.70	15.4	13.6	625	512	17.13	14.05
February	28.0	-2.40	36.1	33.3	1559	1351	18.25	15.82
March	66.0	0.30	75.4	71.2	3287	2925	18.43	16.40
April	106.0	4.70	115.3	109.9	4957	4463	18.18	16.37
May	172.0	10.10	180.0	172.6	7544	6847	17.72	16.09
June	166.0	13.90	170.6	163.7	7063	6397	17.51	15.86
July	169.0	17.00	175.4	168.4	7164	6494	17.27	15.66
August	131.0	16.20	140.3	134.2	5762	5209	17.36	15.70
September	78.0	13.20	88.2	83.8	3675	3289	17.62	15.77
October	37.0	8.70	44.0	41.2	1853	1614	17.80	15.51
November	15.0	3.70	20.6	18.5	837	700	17.14	14.36
December	8.0	0.80	13.8	11.1	502	410	15.39	12.56
Year	987.0	7.10	1075.3	1021.5	44827	40211	17.63	15.82

Legends:	GlobHor	Horizontal global irradiation	EArray	Effective energy at the output of the array
	T Amb	Ambient Temperature	E_Grid	Energy injected into grid
	GlobInc	Global incident in coll. plane	EffArrR	Effic. Eout array / rough area
	GlobEff	Effective Global, corr. for IAM and shadings	EffSysR	Effic. Eout system / rough area

ZEB WP5 concept - office

Grid-Connected System: Loss diagram

Project : Grid-Connected Project at Oslo
Simulation variant : office 3 rows - south

Main system parameters	System type	Grid-Connected		
Near Shadings	Linear shadings			
PV Field Orientation	tilt	10°	azimuth	0°
PV modules	Model	SPR-333NE-WHT-D	Pnom	333 Wp
PV Array	Nb. of modules	145	Pnom total	48.3 kWp
Inverter	Model	Sunny Boy SB 1700	Pnom	1550 W ac
Inverter pack	Nb. of units	29.0	Pnom total	45.0 kW ac
User's needs	Unlimited load (grid)			

Loss diagram over the whole year

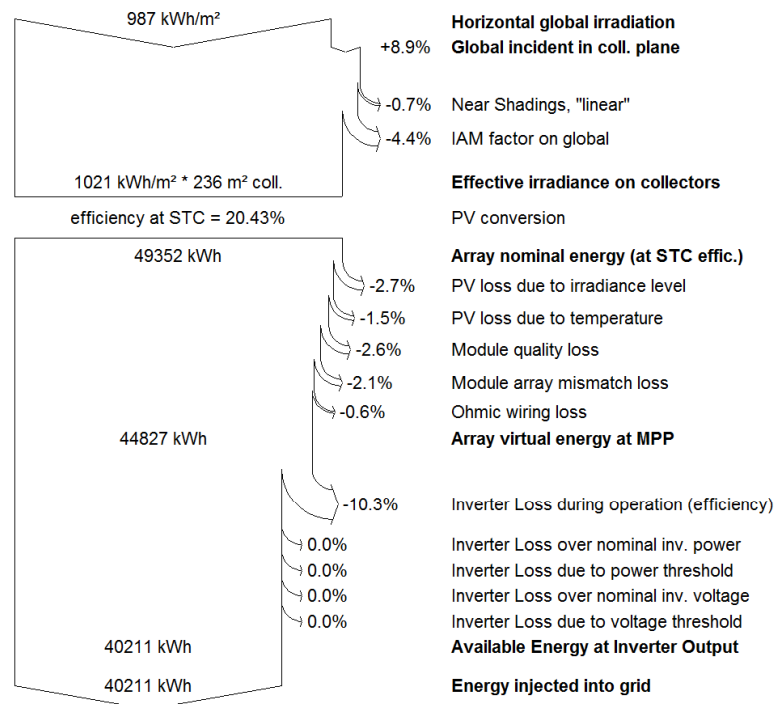

D.2 Results north facing panels on the roof

PVSYST V5.56	Sintef Building and Infrastructure		20/11/12	Page 1/4
ZEB WP5 concept - office				
Grid-Connected System: Simulation parameters				
Project :	Grid-Connected Project at Oslo			
Geographical Site	Oslo	Country	Norway	
Situation	Latitude	59.5°N	Longitude	10.4°E
Time defined as	Legal Time	Time zone UT+1	Altitude	5 m
	Albedo	0.20		
Meteo data :	Oslo, Synthetic Hourly data			
Simulation variant :	office 4 rows - north			
	Simulation date	20/11/12 22h23		
Simulation parameters				
Collector Plane Orientation	Tilt	10°	Azimuth	180°
Horizon	Free Horizon			
Near Shadings	Linear shadings			
PV Array Characteristics				
PV module	Si-mono	Model	SPR-333NE-WHT-D	
		Manufacturer	SunPower	
Number of PV modules		In series	4 modules	In parallel 29 strings
Total number of PV modules		Nb. modules	116	Unit Nom. Power 333 Wp
Array global power		Nominal (STC)	38.6 kWp	At operating cond. 34.9 kWp (50°C)
Array operating characteristics (50°C)		U mpp	195 V	I mpp 179 A
Total area		Module area	189 m²	Cell area 171 m²
Inverter				
		Model	Sunny Boy SB 1200	
		Manufacturer	SMA	
Characteristics		Operating Voltage	100-320 V	Unit Nom. Power 1.20 kW AC
Inverter pack		Number of Inverter	29 units	Total Power 34.80 kW AC
PV Array loss factors				
Thermal Loss factor	Uc (const)	20.0 W/m²K	Uv (wind)	0.0 W/m²K / m/s
=> Nominal Oper. Coll. Temp. (G=800 W/m², Tamb=20°C, Wind=1 m/s.)			NOCT	56 °C
Wiring Ohmic Loss	Global array res.	18 mOhm	Loss Fraction	1.5 % at STC
Module Quality Loss			Loss Fraction	2.5 %
Module Mismatch Losses			Loss Fraction	2.0 % at MPP
Incidence effect, ASHRAE parametrization	IAM =	1 - bo (1/cos i - 1)	bo Parameter	0.05
User's needs :	Unlimited load (grid)			

ZEB WP5 concept - office

Grid-Connected System: Near shading definition

Project : Grid-Connected Project at Oslo
Simulation variant : office 4 rows - north

Main system parameters	System type	Grid-Connected		
Near Shadings	Linear shadings			
PV Field Orientation	tilt	10°	azimuth	180°
PV modules	Model	SPR-333NE-WHT-D	Pnom	333 Wp
PV Array	Nb. of modules	116	Pnom total	38.6 kWp
Inverter	Model	Sunny Boy SB 1200	Pnom	1200 W ac
Inverter pack	Nb. of units	29.0	Pnom total	34.8 kW ac
User's needs	Unlimited load (grid)			

Perspective of the PV-field and surrounding shading scene

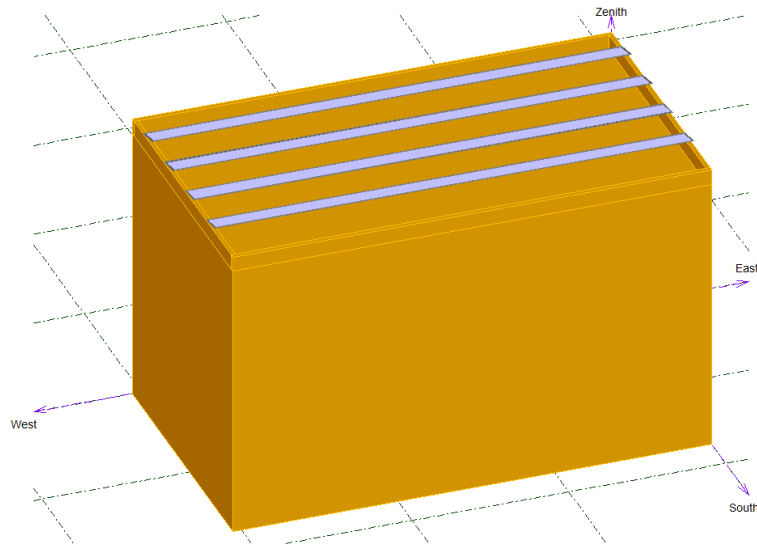

Iso-shadings diagram

Grid-Connected Project at Oslo: Office Option1 - 10deg 4 rows

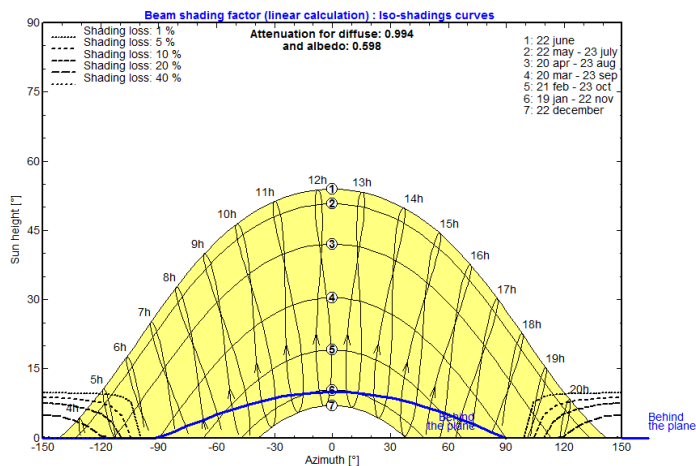

ZEB WP5 concept - office

Grid-Connected System: Main results

Project : Grid-Connected Project at Oslo
Simulation variant : office 4 rows - north

Main system parameters	System type	Grid-Connected	
Near Shadings	Linear shadings		
PV Field Orientation	tilt	10°	azimuth 180°
PV modules	Model	SPR-333NE-WHT-D	Pnom 333 Wp
PV Array	Nb. of modules	116	Pnom total 38.6 kWp
Inverter	Model	Sunny Boy SB 1200	Pnom 1200 W ac
Inverter pack	Nb. of units	29.0	Pnom total 34.8 kW ac
User's needs	Unlimited load (grid)		

Main simulation results
System Production **Produced Energy 25.96 MWh/year** Specific prod. 672 kWh/kWp/year
Performance Ratio PR 76.1 %

Normalized productions (per installed kWp): Nominal power 38.6 kWp

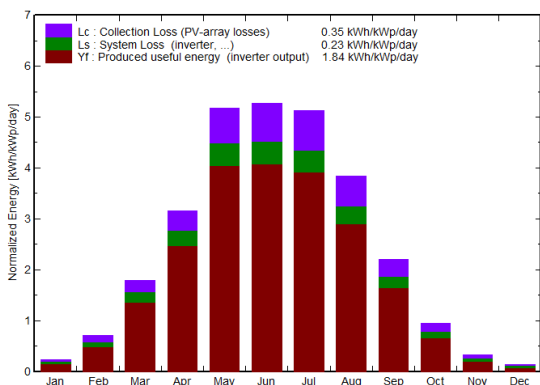

Performance Ratio PR

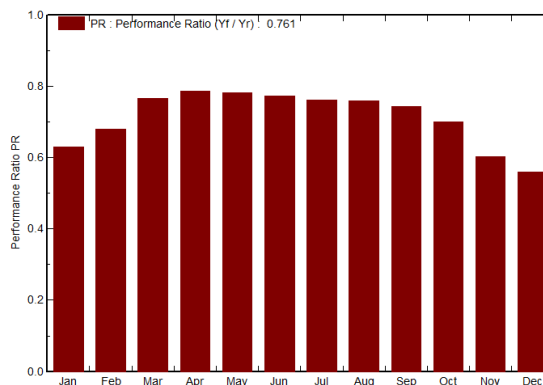

office 4 rows - north
Balances and main results

	GlobHor	T Amb	GlobInc	GlobEff	EArray	E_Grid	EffArrR	EffSysR
	kWh/m²	°C	kWh/m²	kWh/m²	MWh	MWh	%	%
January	11.0	-1.70	7.3	6.8	0.238	0.176	17.35	12.85
February	28.0	-2.40	19.7	17.1	0.632	0.518	16.97	13.91
March	66.0	0.30	55.3	50.5	1.871	1.635	17.89	15.64
April	106.0	4.70	94.5	88.4	3.222	2.874	18.03	16.08
May	172.0	10.10	160.4	151.7	5.378	4.848	17.73	15.98
June	166.0	13.90	158.1	150.3	5.244	4.722	17.54	15.79
July	169.0	17.00	159.1	151.1	5.204	4.687	17.29	15.57
August	131.0	16.20	118.9	111.9	3.888	3.484	17.29	15.49
September	78.0	13.20	66.2	61.1	2.159	1.903	17.23	15.19
October	37.0	8.70	29.4	26.4	0.943	0.794	16.98	14.30
November	15.0	3.70	9.8	8.7	0.302	0.229	16.19	12.32
December	8.0	0.80	4.3	4.1	0.135	0.093	16.59	11.46
Year	987.0	7.10	882.9	828.2	29.215	25.965	17.49	15.55

Legends:	GlobHor	Horizontal global irradiation	EArray	Effective energy at the output of the array
	T Amb	Ambient Temperature	E_Grid	Energy injected into grid
	GlobInc	Global incident in coll. plane	EffArrR	Effic. Eout array / rough area
	GlobEff	Effective Global, corr. for IAM and shadings	EffSysR	Effic. Eout system / rough area

ZEB WP5 concept - office

Grid-Connected System: Loss diagram

Project : Grid-Connected Project at Oslo
Simulation variant : office 4 rows - north

Main system parameters	System type	Grid-Connected		
Near Shadings	Linear shadings			
PV Field Orientation	tilt	10°	azimuth	180°
PV modules	Model	SPR-333NE-WHT-D	Pnom	333 Wp
PV Array	Nb. of modules	116	Pnom total	38.6 kWp
Inverter	Model	Sunny Boy SB 1200	Pnom	1200 W ac
Inverter pack	Nb. of units	29.0	Pnom total	34.8 kW ac
User's needs	Unlimited load (grid)			

Loss diagram over the whole year

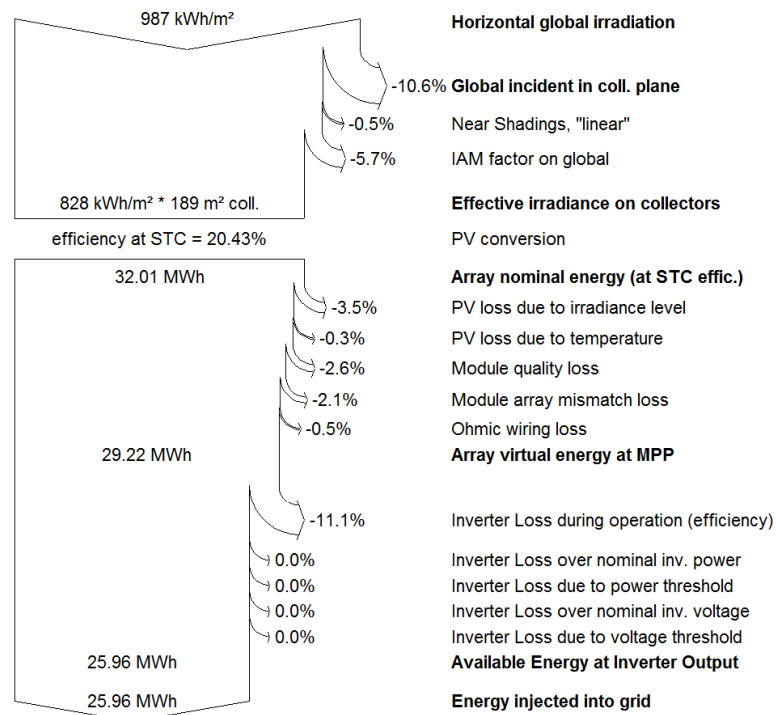

D.3 Results panels on the south facade

PVSYST V5.56	Sintef Building and Infrastructure		20/11/12	Page 1/3
ZEB WP5 concept - office				
Grid-Connected System: Simulation parameters				
Project :	Grid-Connected Project at Oslo			
Geographical Site	Oslo	Country	Norway	
Situation	Latitude	59.5°N	Longitude	10.4°E
Time defined as	Legal Time	Time zone UT+1	Altitude	5 m
	Albedo	0.20		
Meteo data :	Oslo, Synthetic Hourly data			
Simulation variant :	facade - south			
	Simulation date	20/11/12 22h57		
Simulation parameters				
Collector Plane Orientation	Tilt	90°	Azimuth	0°
Horizon	Free Horizon			
Near Shadings	No Shadings			
PV Array Characteristics				
PV module	Si-mono	Model	SPR-333NE-WHT-D	
		Manufacturer	SunPower	
Number of PV modules		In series	11 modules	In parallel 6 strings
Total number of PV modules		Nb. modules	66	Unit Nom. Power 333 Wp
Array global power		Nominal (STC)	21.98 kWp	At operating cond. 19.84 kWp (50°C)
Array operating characteristics (50°C)		U mpp	537 V	I mpp 37 A
Total area		Module area	108 m²	Cell area 97.1 m²
Inverter				
		Model	Convert 4000	
		Manufacturer	Solar Fabrik	
Characteristics		Operating Voltage	400-800 V	Unit Nom. Power 3.80 kW AC
Inverter pack		Number of Inverter	6 units	Total Power 22.80 kW AC
PV Array loss factors				
Thermal Loss factor	Uc (const)	20.0 W/m²K	Uv (wind)	0.0 W/m²K / m/s
=> Nominal Oper. Coll. Temp. (G=800 W/m², Tamb=20°C, Wind=1 m/s.)			NOCT	56 °C
Wiring Ohmic Loss	Global array res.	244 mOhm	Loss Fraction	1.5 % at STC
Module Quality Loss			Loss Fraction	2.5 %
Module Mismatch Losses			Loss Fraction	2.0 % at MPP
Incidence effect, ASHRAE parametrization	IAM =	1 - bo (1/cos i - 1)	bo Parameter	0.05
User's needs :	Unlimited load (grid)			

ZEB WP5 concept - office

Grid-Connected System: Loss diagram

Project : Grid-Connected Project at Oslo
Simulation variant : facade - south

Main system parameters	System type	Grid-Connected		
PV Field Orientation	tilt	90°	azimuth	0°
PV modules	Model	SPR-333NE-WHT-D	Pnom	333 Wp
PV Array	Nb. of modules	66	Pnom total	21.98 kWp
Inverter	Model	Convert 4000	Pnom	3800 W ac
Inverter pack	Nb. of units	6.0	Pnom total	22.80 kW ac
User's needs	Unlimited load (grid)			

Loss diagram over the whole year

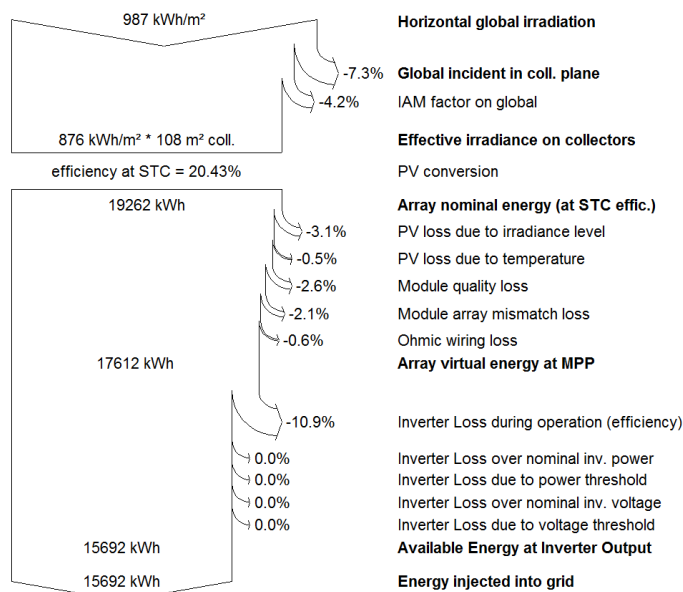

COMMENT: The simulation for the vertical south façade is done with 66 modules (106 m²). However the real number of modules on the south façade is 156. The correct output from the façade is therefore: $15692 \times 156 / 66 = 37\,090$ kWh/a.

The Research Centre on Zero emission Buildings (ZEB)

The main objective of ZEB is to develop competitive products and solutions for existing and new buildings that will lead to market penetration of buildings that have zero emissions of greenhouse gases related to their production, operation and demolition. The Centre will encompass both residential and commercial buildings, as well as public buildings.

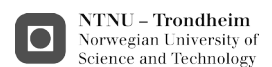

Partners

NTNU
www.ntnu.no

SINTEF
www.sintef.no

Skanska
www.skanska.no

Weber
www.weber-norge.no

Isola
www.isola.no

Glava
www.glava.no

Protan
www.protan.no

Hydro Aluminium
www.hydro.com

YIT
www.yit.no

ByBo
www.bybo.no

Multiconsult
www.multiconsult.no

Brødrene Dahl
www.dahl.no

Snohetta
www.snoarc.no

Forsvarsbygg
www.forsvarsbygg.no

Statsbygg
www.statsbygg.no

Husbanken
www.husbanken.no

Byggenæringens Landsforening
www.bnl.no

Norsk Teknologi
www.norskteknologi.no

Direktoratet for byggkvalitet
www.dibk.no

DuPont
www.dupont.com

NorDan AS
www.nordan.no

Enova
www.enova.no

Velux
www.velux.com

Entra
www.entra.no